

Life Is On

Schneider  
Electric



 Price List

# Final Distribution, Wiring Devices and Lighting Control Products

With effect from March 12, 2018



[schneider-electric.co.in](http://schneider-electric.co.in)



**Acti 9 Distribution System**

- > Miniature Circuit Breakers (MCBs) . . . . . 08
- > Residual Current Devices (RCDs) . . . . . 11
- > Auxiliaries and Accessories for MCBs/RCDs . . . . . 14
- > Surge Protection Devices (SPDs) . . . . . 16
- > Control and Command Products . . . . . 18
- > ComReady Control and Command Products . . . . . 20
- > Modular Distribution Boards - Metallic . . . . . 26

**Enclosures and Plugs & Sockets**

- > NeoBreak Distribution Boards . . . . . 30
- > Kaedra Enclosures - Weather Proof . . . . . 32
- > PratiKa Plugs & Sockets - IP44 / IP67 . . . . . 34
- > Electra Metal Clad Plugs & Sockets . . . . . 38
- > 56 Series Plugs & Sockets - IP56 / IP66 . . . . . 39

**Wiring Devices**

- > Wiser Odace™ LIGHTING . . . . . 43
- > LIVIA . . . . . 44
- > Opale . . . . . 45
- > ZENcelo India . . . . . 48
- > ZENcelo BS . . . . . 50
- > NEO . . . . . 52
- > ULTI Impress . . . . . 54
- > Kavacha . . . . . 56
- > Metal Boxes . . . . . 57

**Control System**

- > EzInstall3 - ULTIZIGBEE . . . . . 58
- > WISER Home . . . . . 59
- > Sympholux - KNX, C-Bus, DALI . . . . . 60
- > Hotel Series . . . . . 61
- > Argus . . . . . 63
- > Control and Command Products . . . . . 64
- > Analog Timers . . . . . 65

**Structured Cabeling Solutions**

- > Datacomms . . . . . 66

# Acti 9 | Advanced Communication Technology that Inspires

## > Protection devices

- Miniature circuit breakers
- Residual current circuit breakers
- Vigi™ residual current devices
- Surge Protection Devices

## > Protection monitoring and supervision

- Indication and tripping auxiliaries
- Remote control auxiliaries
- Automatic reclosure auxiliaries



Innovative  
Protection monitoring Total control and  
Metering @ DB level



Efficient  
Manage loads, reduce operating and project  
costs, and accurately plan maintenance

## > Control and monitoring

- Contactors
- Impulse relays
- Integrated control circuit breakers
- Light indicators
- Push-buttons and selector switches
- Kilowatt hour meters
- Communicating architecture

## > Installation system

- IP20B terminals
- Splitter blocks
- Full range of mounting and wiring accessories



Reliable

Dual certifications for one product, 100 percent MCB and RCD coordination, easy ordering and design, error free fast connections

# Acti 9 | Advanced Communication Technology that Inspires.....

## > Innovative

- Centralized control system including energy metering
- Large and variable data reading and computing through universal Modbus protocol

## > Efficient

- One-click, prefabricated wiring for comprehensive communication between your distribution board or panel and any facility management system

## > Reliable

- Error proof connection leading to reduction in downtime
- EMC tested for immunity, radiated and conducted safety

**NEW**

Email Notification upon Event (Devices Status Change, Alarm threshold reached etc.)

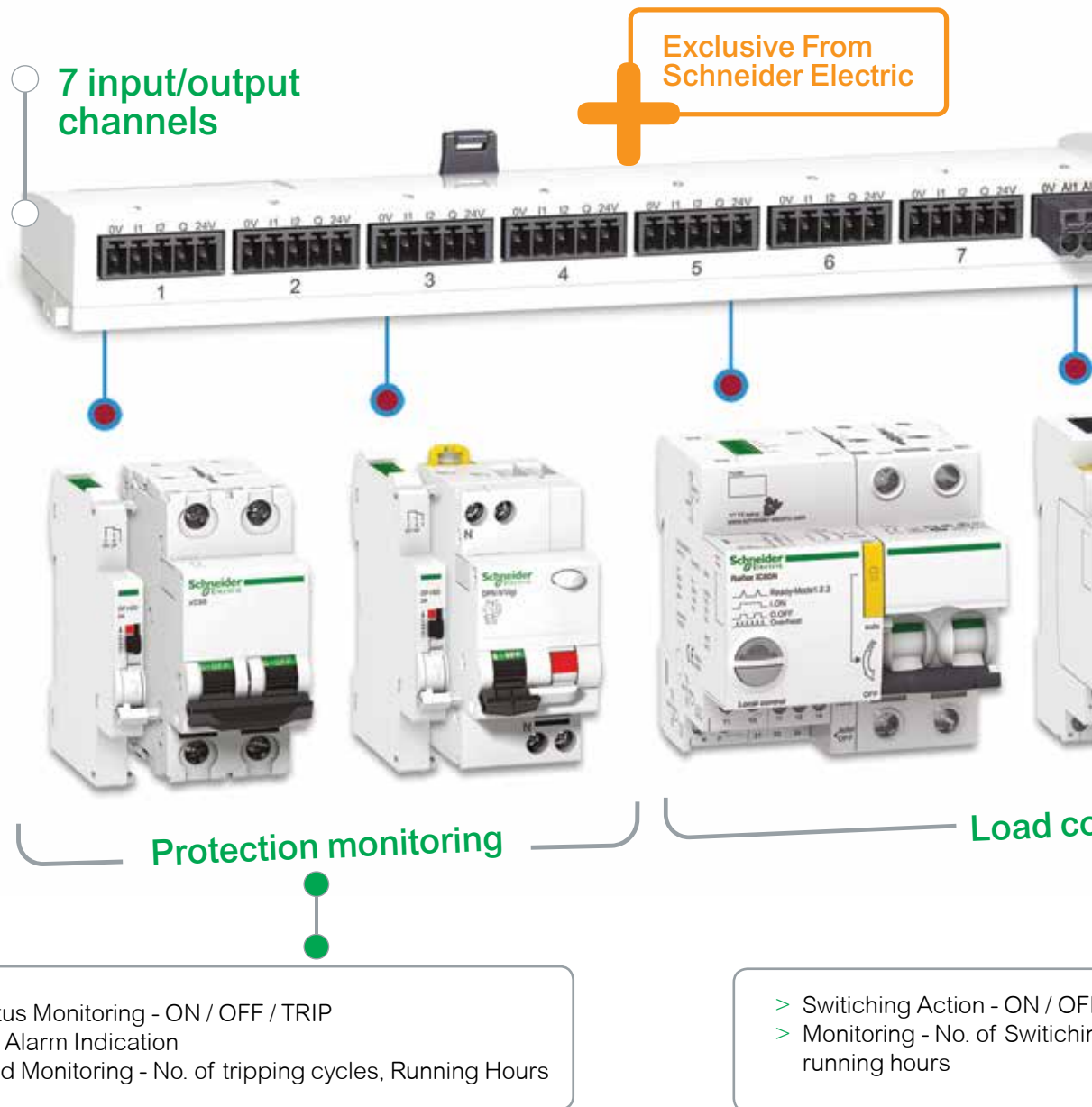

Meets the challenge of all your applications

Detailed load control, reduced downtime and accurately planned maintenance

# Ready to connect to any facility management solution

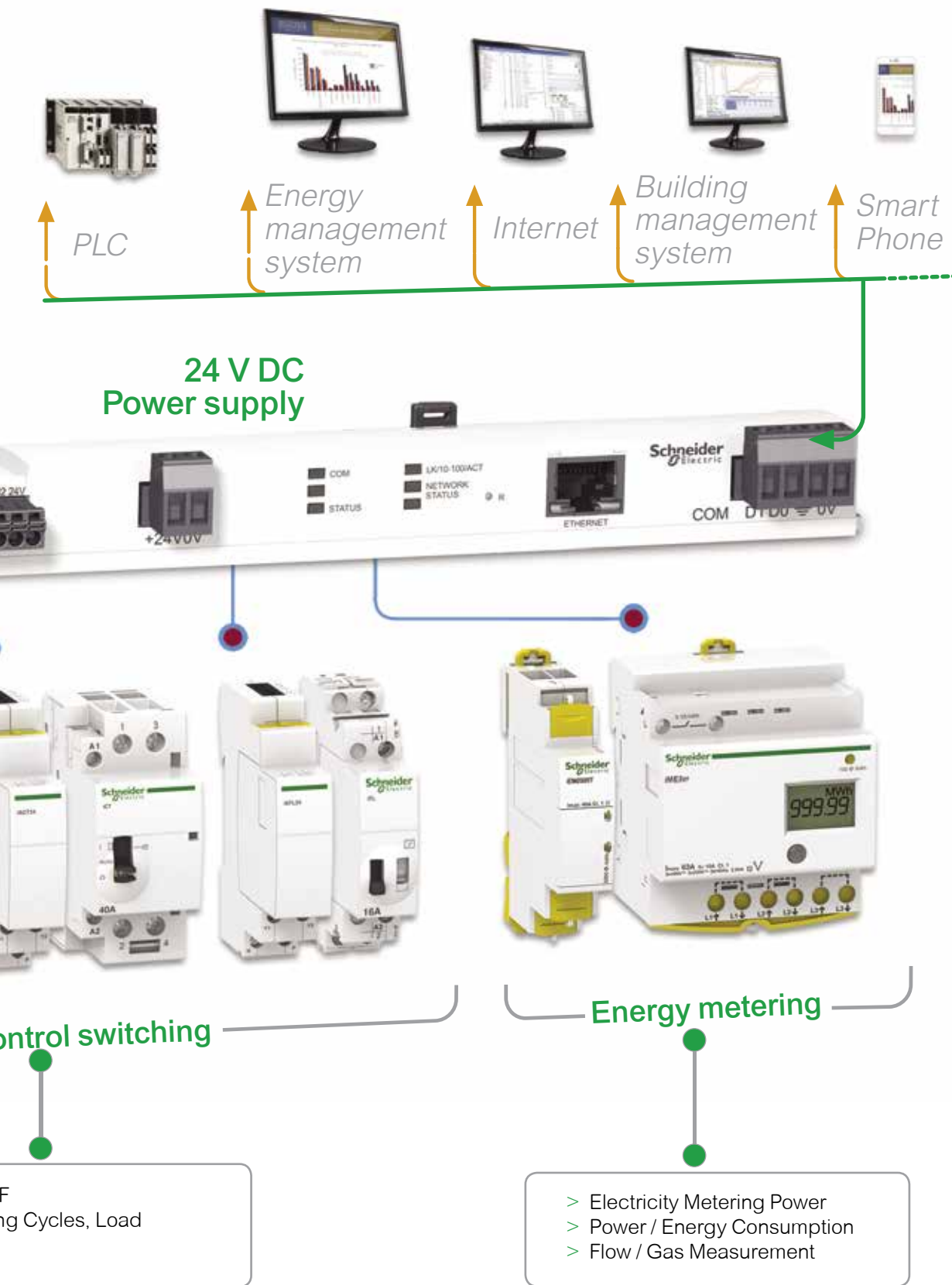

**Green Premium Products**  
 100% Recyclable and Recoverable  
 REACH, ROHS, PEP, EOL1 compliant

### AC Miniature Circuit Breakers - xC60



- Breaking Capacity as per IEC 60898 and IS/IEC 60898-1, Icn = 10kA
- Breaking Capacity as per IEC 60947-2, Icn = 15kA, upto 40A
- Can be used for DC application upto 60V per pole
- Higher system performance with optimized cost: Cascading\*
- Increased System Continuity: Discrimination\*
- Higher Installation Life: Energy Limitation Class 3, Fast Closure Mechanism
- Ease, Speed and Flexibility of installation - Biconnect, Line-Load Reversible
- Field-fittable auxiliaries for advance protection and monitoring
- Positive Contact Indication for assurance of disconnection

[In] Rated Current (A)	1 Pole Reference	Unit LP [₹]	2 Pole Reference	Unit LP [₹]	3 Pole Reference	Unit LP [₹]	4 Pole Reference	Unit LP [₹]
Module Width**	1 mod		2 mod		3 mod		4 mod	
MOQ	12 Nos.		6 Nos.		4 Nos.		3 Nos.	

#### B curve

6	A9N1P06B ✓	298	A9N2P06B ✓	902	A9N3P06B ✓	1475	A9N4P06B ✓	1990
10	A9N1P10B ✓	298	A9N2P10B ✓	902	A9N3P10B ✓	1475	A9N4P10B ✓	1990
16	A9N1P16B ✓	298	A9N2P16B ✓	902	A9N3P16B ✓	1475	A9N4P16B ✓	1990
20	A9N1P20B ✓	298	A9N2P20B ✓	902	A9N3P20B ✓	1475	A9N4P20B ✓	1990
25	A9N1P25B ✓	298	A9N2P25B ✓	902	A9N3P25B ✓	1475	A9N4P25B ✓	1990
32	A9N1P32B ✓	298	A9N2P32B ✓	902	A9N3P32B ✓	1475	A9N4P32B ✓	1990
40	A9N1P40B ✓	660	A9N2P40B ✓	1455	A9N3P40B ✓	2250	A9N4P40B ✓	2865
50	A9N1P50B ✓	660	A9N2P50B ✓	1455	A9N3P50B ✓	2250	A9N4P50B ✓	2865
63	A9N1P63B ✓	660	A9N2P63B ✓	1455	A9N3P63B ✓	2250	A9N4P63B ✓	2865

#### C curve

1	A9N1P01C ✓	464	A9N2P01C ✓	1255	A9N3P01C ✓	1940	A9N4P01C ✓	2450
2	A9N1P02C ✓	464	A9N2P02C ✓	1255	A9N3P02C ✓	1940	A9N4P02C ✓	2450
3	A9N1P03C ✓	464	A9N2P03C ✓	1255	A9N3P03C ✓	1940	A9N4P03C ✓	2450
4	A9N1P04C ✓	464	A9N2P04C ✓	1255	A9N3P04C ✓	1940	A9N4P04C ✓	2450
6	A9N1P06C ✓	298	A9N2P06C ✓	902	A9N3P06C ✓	1475	A9N4P06C ✓	1990
10	A9N1P10C ✓	298	A9N2P10C ✓	902	A9N3P10C ✓	1475	A9N4P10C ✓	1990
16	A9N1P16C ✓	298	A9N2P16C ✓	902	A9N3P16C ✓	1475	A9N4P16C ✓	1990
20	A9N1P20C ✓	298	A9N2P20C ✓	902	A9N3P20C ✓	1475	A9N4P20C ✓	1990
25	A9N1P25C ✓	298	A9N2P25C ✓	902	A9N3P25C ✓	1475	A9N4P25C ✓	1990
32	A9N1P32C ✓	298	A9N2P32C ✓	902	A9N3P32C ✓	1475	A9N4P32C ✓	1990
40	A9N1P40C ✓	660	A9N2P40C ✓	1455	A9N3P40C ✓	2250	A9N4P40C ✓	2865
50	A9N1P50C ✓	660	A9N2P50C ✓	1455	A9N3P50C ✓	2250	A9N4P50C ✓	2865
63	A9N1P63C ✓	660	A9N2P63C ✓	1455	A9N3P63C ✓	2250	A9N4P63C ✓	2865

#### D curve

1	A9N1P01D ✓	468	A9N2P01D	1265	A9N3P01D ✓	1980	----	----
2	A9N1P02D ✓	468	A9N2P02D ✓	1265	A9N3P02D ✓	1980	A9N4P02D	2465
3	A9N1P03D ✓	468	A9N2P03D ✓	1265	A9N3P03D ✓	1980	A9N4P03D	2465
4	A9N1P04D ✓	468	A9N2P04D ✓	1265	A9N3P04D ✓	1980	A9N4P04D	2465
6	A9N1P06D ✓	394	A9N2P06D ✓	946	A9N3P06D ✓	1550	A9N4P06D ✓	2065
10	A9N1P10D ✓	394	A9N2P10D ✓	946	A9N3P10D ✓	1550	A9N4P10D ✓	2065
16	A9N1P16D ✓	394	A9N2P16D ✓	946	A9N3P16D ✓	1550	A9N4P16D ✓	2065
20	A9N1P20D ✓	394	A9N2P20D ✓	946	A9N3P20D ✓	1550	A9N4P20D ✓	2065
25	A9N1P25D ✓	394	A9N2P25D ✓	946	A9N3P25D ✓	1550	A9N4P25D ✓	2065
32	A9N1P32D ✓	394	A9N2P32D ✓	946	A9N3P32D ✓	1550	A9N4P32D ✓	2065
40	A9N1P40D ✓	712	A9N2P40D ✓	1540	A9N3P40D ✓	2385	A9N4P40D ✓	2995
50	A9N1P50D ✓	712	A9N2P50D ✓	1540	A9N3P50D ✓	2385	A9N4P50D ✓	2995
63	A9N1P63D ✓	712	A9N2P63D ✓	1540	A9N3P63D ✓	2385	A9N4P63D ✓	2995

**Note:** \* Please contact nearest Schneider Electric Sales Office or Customer Care Center for coordination chart  
\*\*18mm/module



### AC Miniature Circuit Breakers - C120



- Breaking capacity as per IEC 60898, Icn = 10kA/15kA
- Positive Contact Indication for assurance of disconnection
- Degree of pollution: 3 (suitable for industrial environment)
- Operating Temperature: -30 to 70°C
- Terminal connections: Flexible cables up to 35 sq.mm; Rigid cables up to 50 sq.mm

[In] Rated Current (A)	1 Pole Reference	Unit LP (₹)	2 Pole Reference	Unit LP (₹)	3 Pole Reference	Unit LP (₹)	4 Pole Reference	Unit LP (₹)
Module Width**	1.5 mod		3 mod		4.5 mod		6 mod	
MOQ	12 Nos.		6 Nos.		4 Nos.		3 Nos.	
<b>C120N (10kA)</b>								
80	A9N18357 ✓	2400	A9N18361 ✓	5325	A9N18365 ✓	8390	A9N18372 ✓	10930
100	A9N18358 ✓	2695	A9N18362 ✓	5680	A9N18367 ✓	8940	A9N18374 ✓	11395
125	A9N18359 ✓	2905	A9N18363 ✓	6245	A9N18369 ✓	9915	A9N18376 ✓	12890
<b>C120H (15kA)</b>								
80	A9N18446	2880	A9N18457	6475	A9N18468	9860	A9N18479	12660
100	A9N18447	3175	A9N18458	6635	A9N18469	10740	A9N18480	13645
125	A9N18448	3470	A9N18459	7530	A9N18470	11590	A9N18481	14825

### DC Miniature Circuit Breakers - C60H



- Specially designed MCB for enhanced protection in DC installation
- Magnetic Arc Chutes to quick break DC current in event of fault
- Breaking capacity 6kA as per IEC 60947-2
- Voltage Rating: 1P - 250 V DC & 2P - 500 V DC
- Impulse Voltage: 6 kV
- Higher Installation Life: Energy Limiting Class: 3

[In] Rated Current (A)	Module Width 18mm/ module	1 Pole Reference	Unit LP (₹)	Module Width 18mm/ module	2 Pole Reference	Unit LP (₹)
MOQ		12 Nos.			6 Nos.	
<b>C60H-DC</b>						
0.5	1	A9N61500	892	2	A9N61520	1885
1	1	A9N61501 ✓	790	2	A9N61521 ✓	1635
2	1	A9N61502 ✓	790	2	A9N61522 ✓	1635
3	1	A9N61503 ✓	790	2	A9N61523 ✓	1635
4	1	A9N61504 ✓	790	2	A9N61524 ✓	1635
5	1	A9N61505	790	2	A9N61525	1635
6	1	A9N61506 ✓	648	2	A9N61526 ✓	1385
10	1	A9N61508 ✓	648	2	A9N61528 ✓	1385
16	1	A9N61511 ✓	648	2	A9N61531 ✓	1385
20	1	A9N61512 ✓	648	2	A9N61532 ✓	1385
25	1	A9N61513 ✓	648	2	A9N61533 ✓	1385
32	1	A9N61515 ✓	648	2	A9N61535 ✓	1385
40	1	A9N61517 ✓	888	2	A9N61537 ✓	1965
50	1	A9N61518 ✓	888	2	A9N61538 ✓	1965
63	1	A9N61519 ✓	888	2	A9N61539 ✓	1965

### Special application MCBs



#### Solar Application – PV DC

- DC MCB for multi string PV installations
- Operating Voltage: 800V DC
- Current Rating up to 25A
- Complies to IEC / EN 60947-2



#### Rail Application\* (including Rolling Stock)

- Fire & smoke Resistant – Level 2 (NF F 16-101, NF F 16-102)
- Shock & vibration resistant (IEC 61373) – Cat 1, Class B
- Breaking Capacity: up to 25kA
- Complies to IEC / EN 60947-2



#### UL MCB

- Type: UL1077, UL489
- Breaking Capacity of 10kA
- Complies to IEC 60947-2 / UL1077 / UL489 / CSA

#### Note:

Please contact nearest Schneider Electric sales office or Customer Care for Reference and prices of Application Specific MCBs

\*Rail Application RCDs are also available on demand

\*\*18mm/module

Please contact Customer Care Center for Stockable and Non stockable status of references.

✓ NORMAL STOCK ITEMS

W.E.F. March 12, 2018

### AC Miniature Circuit Breakers - NG125



- Compliance to IEC / EN 60947-2
- High Breaking Capacity MCBs – up to 50kA
- Current Rating up to 125A
- Trip on fault indication on front face of MCB
- Suitability for isolation in the industrial sector to IEC/EN 60947-2
- Available in B, C, D Curves

[In] Rated Current (A)	1 Pole Reference	Unit LP [₹]	2 Pole Reference	Unit LP [₹]	3 Pole Reference	Unit LP [₹]	4 Pole Reference	Unit LP [₹]
Module Width**	1.5 mod		3 mod		4.5 mod		6 mod	

#### NG125N – 25kA Breaking Capacity

10	18610	*	18621	*	18632	*	18649	*
16	18611	*	18622	*	18633	*	18650	*
20	18612	*	18623	*	18634	*	18651	*
25	18613	*	18624	*	18635	*	18652	*
32	18614	*	18625	*	18636	*	18653	*
40	18615	*	18626	*	18637	*	18654	*
50	18616	*	18627	*	18638	*	18655	*
63	18617	*	18628	*	18639	*	18656	*
80	18618	*	18629	*	18640	*	18658	*

#### NG125H – 36kA Breaking Capacity

10	18705	*	18714	*	18723	*	18732	*
16	18706	*	18715	*	18724	*	18733	*
20	18707	*	18716	*	18725	*	18734	*
25	18708	*	18717	*	18726	*	18735	*
32	18709	*	18718	*	18727	*	18736	*
40	18710	*	18719	*	18728	*	18737	*
50	18711	*	18720	*	18729	*	18738	*
63	18712	*	18721	*	18730	*	18739	*
80	18713	*	18722	*	18731	*	18740	*

#### NG125H – 50kA Breaking Capacity

10	18777	*	18788	*	18799	*	18810	*
16	18778	*	18789	*	18800	*	18811	*
20	18779	*	18790	*	18801	*	18812	*
25	18780	*	18791	*	18802	*	18813	*
32	18781	*	18792	*	18803	*	18814	*
40	18782	*	18793	*	18804	*	18815	*
50	18783	*	18794	*	18805	*	18816	*
63	18784	*	18795	*	18806	*	18817	*
80	18785	*	18796	*	18807	*	18818	*

\*Price on Request – Please contact Schneider Electric Customer Care Center for Prices

\*\*18mm/module

**Note:** Reference provided above are for C Curve MCBs – B and D Curve details available on request

# Residual Current Devices (RCDs) - For Human and Fire Protection



**30  
mA**

Use of **30mA RCDs** is now **mandatory** for all **domestic intallations** in India {CEA Amendment regulation 2015\*}



**Schneider Electric provides voltage independent RCDs** which work on current sensing technology and provide protection from residual current even at extra low voltages (down to zero volts) and in case of break of neutral.

**SI  
Type**

**Schneider Electric offers SI RCD built to operate in electrically polluted or installation in aggressive environments:**

- Flourescent / Variable lighting with Electronic ballast
- Powerful IT / Telecom equipment / Air conditioning
- Severe Atmosphere - High lighting risk / Swimming pools

\* for Measures relating to Safety and Electric supply

Please contact Customer Care Center for Stockable and Non stockable status of references.

NORMAL STOCK ITEMS

W.E.F. March 12, 2018

### AC Residual Current Circuit Breakers - xID



Suitable for  
ComReady  
Auxiliary



- Complies to standards IEC/EN 61008-1 and IS 12640
- AC Class protection
- Selective range available for time based discrimination
- Easy Monitoring: Earth fault indication and Test Button on front face
- Operating temperature up to +70°C
- Mandatory to use OF-S auxiliary to add any indication or tripping auxiliary

[In] Rated Current (A)	Earth-Leakage Sensitivity (mA)	Module Width 18mm/module	2 Pole Reference	Unit LP [₹]	Module Width 18mm/module	4 Pole Reference	Unit LP [₹]
25	30	2	A9N16201	3220	4	A9N16251	4400
	100	2	A9N16203	3445	4	A9N16253	4585
	300	2	A9N16202	3550	4	A9N16252	4725
40	30	2	A9N16204	3795	4	A9N16254	4415
	100	2	A9N16205	4015	4	A9N16255	4615
	300	2	A9N16206	4130	4	A9N16256	4795
63	30	2	A9N16208	4485	4	A9N16258	5115
	100	2	A9N16209	4735	4	A9N16259	5455
	300	2	A9N16210	4830	4	A9N16260	5480
80	30	2	A9N16212	7545	4	A9N16261	8850
	100	2	A9N16213	7530	4	A9N16262	8830
	300	2	A9N16214	7670	4	A9N16263	8880

### AC Residual Current Circuit Breakers (RCCBs) - ID



- Complies to standards IEC 61008-1 and VDE 0664
- AC Class protection
- Degree of pollution: 3 (suitable for industrial environment)
- Electrical ON/OFF indication by using OFSP auxiliary

Poles Description	[In] Rated Current (A)	Earth-Leakage Sensitivity (mA)	Module Width 18mm/module	Reference	Unit LP [₹]
4P	100	30	4	**A9R11491	10735
		100	4	**A9R12491	11110
	125	30	4	16905	32885
		100	4	16906	33540
		300	4	16907	33700

Note: \*\*For 100A RCCB Auxiliary kindly contact Customer Care

### AC Residual Current Breaker Overload (RCBO) - DPN N Vigji



Suitable for  
ComReady  
Auxiliary



- Complies to standards IEC/EN 61009
- AC Class Protection; Tripping characteristics - C curve
- Overvoltage category (IEC 60364): IV
- Suitable for indication & tripping auxiliaries

Poles Description	[In] Rated Current (A)	Earth-Leakage Sensitivity (mA)	Module Width 18mm/module	Reference	Unit LP [₹]
1P+N	6	30	2	A9N19661	4670
		300	2	A9N19681	4830
	10	30	2	A9N19663	4670
		300	2	A9N19683	4830
	16	30	2	A9N19665	4670
		300	2	A9N19685	4830
	20	30	2	A9N19666	4670
		300	2	A9N19686	4830
	25	30	2	A9N19667	4670
		300	2	A9N19687	4830
	32	30	2	A9N19668	4900
		300	2	A9N19688	5075
	40	30	2	A9N19669	6020
		300	2	A9N19689	6180

Note: Application specific RCDs also available with 10mA, 500mA and 1000mA sensitivities | Please contact nearest Schneider Electric Sales Office or Customer Care Center for Reference and Prices

### SI Type Residual Current Circuit Breakers (RCCBs) - xID SI



- Complies to standard IEC/EN 61008-1
- SI RCDs offer enhanced immunity against Electrical Disturbances; Polluted and Corrosive environments - Guaranteed performance in harsh operating conditions
- Ensures continuity of supply in networks with:
  - Transient overvoltages
  - Loads generating HF leakage current i.e. harmonics
  - Loads generating continuous leakage current
- Ensures tripping on genuine earth fault in networks with:
  - Pulsating DC components
  - HF applications which "Blinds" (non-tripping) the conventional RCDs

[In] Rated Current (A)	Earth-Leakage Sensitivity (mA)	Module Width 18mm/module	2 Pole Reference	Unit LP [₹]	Module Width 18mm/module	4 Pole Reference	Unit LP [₹]
25	30	2	A9N16234	6970	4	A9N16321	7770
40	30	2	A9N16237	7320	4	A9N16324	8015
63	30	2	A9N16240	7530	4	A9N16327	8225
	300	2	A9N16246	7590	4	A9N16334	8565

### Vigi Block for xC60 (Add-on RCD Module, 2 & 4 Pole)



- Flexibility to use MCB of any tripping curve to suit applications, ensuring best 3 in 1 protection
- No auxiliary supply required
- AC Class protection
- Degree of pollution: 3 (suitable for industrial environment)
- Immune to nuisance tripping due to transient over voltages

[In] Rated Current (A)	Earth-Leakage Sensitivity (mA)	Module Width 18mm/module	2 Pole Reference	Unit LP [₹]	Module Width 18mm/module	4 Pole Reference	Unit LP [₹]
25	30	1.5	A9N26581	4420	3	A9N26595	5310
	100	1.5	A9N26582	5525	3	A9N26596	5730
	300	1.5	A9N26583	5695	3	A9N26597	5900
63	30	2	A9N26611	6190	3.5	A9N26643	6505
	100	2	A9N26612	6435	3.5	A9N26644	6635
	300	2	A9N26613	6565	3.5	A9N26645	6765

Note: Vigi Block for High Rating up to 125A (C120) and High Breaking Capacity (NG125) available on demand

### SI Type Residual Current Breaker Overload (RCBO) - DPN N Vigi SI



- Complies to standard IEC/EN 61009
- Ensures continuity of supply in networks with:
  - Transient overvoltages
  - Loads generating HF leakage current i.e. harmonics
  - Loads generating continuous leakage current
- Ensures tripping on genuine earth fault in networks with :
  - Pulsating DC components
  - HF applications which "Blinds" (non-tripping) the conventional RCDs

Poles Description	[In] Rated Current (A)	Earth-Leakage Sensitivity (mA)	Module Width 18mm/module	Reference	Unit LP [₹]
1P+N	6	30	2	A9N19631	8950
		300	2	A9N19641	9475
	10	30	2	A9N19632	8950
		300	2	A9N19642	9475
	16	30	2	A9N19634	8950
		300	2	A9N19644	9475
	20	30	2	A9N19635	8950
		300	2	A9N19645	9475
	25	30	2	A9N19636	8950
		300	2	A9N19646	9475
	32	30	2	A9N19637	9455
		300	2	A9N19647	11545
	40	30	2	A9N19638	11220
		300	2	A9N19648	12485

\*For Prices, please contact nearest Schneider Electric Sales Office or Customer Care Center are Center for Reference and Prices

### Common Auxiliaries for xC60 / C120 / RCDs Range

- Field-fittable auxiliaries (clip fitted) mounted on left side with maximum width of 54mm
- Order: Tripping Auxiliaries (MN first) followed by Indication Auxiliaries (SD first)

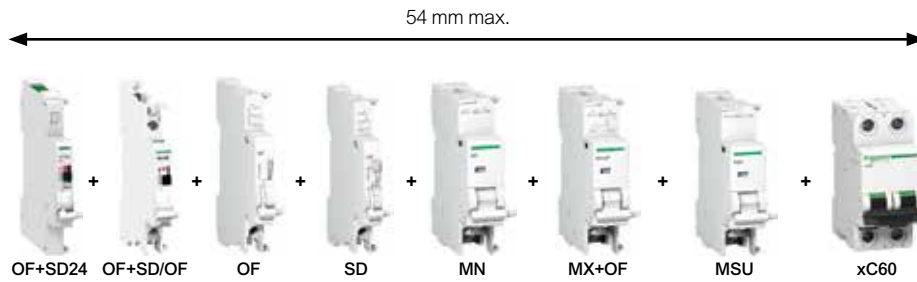

Type	Module Width 18mm/module	Reference	Unit LP [₹]
<b>Indication Auxiliaries</b>			
OF Auxiliary Switch: for ON/OFF indications	0.5	A9N26924	912
SD Alarm Switch: for Trip on fault indications	0.5	A9N26927	1070
OF + SD/OF Auxiliary switch	0.5	A9N26929	2850
OF+SD24 auxiliary contact (ComReady)	0.5	A9N26899	2390
<b>Protection Auxiliaries – Trip Indication on front face</b>			
MN Under-voltage Release 220-240V AC	1	A9N26960	3100
MSU Over-voltage Release 275V AC	1	A9N26500	4545
<b>Tripping Auxiliaries – Trip Indication on front face</b>			
MX + OF Shunt Release 110-415V AC: for Remote tripping of Circuit Breaker	1	A9N26946	2495
MX + OF Shunt Release 12-24V AC/DC: for Remote tripping of Circuit Breaker	1	A9N26948	2495
<b>Auxiliary Switch for RCCBs – Mandatory for use of Auxiliaries with RCCBs</b>			
Auxiliary switch for RCCB up to 80A (OF-S)	0.5	A9N26923	1215
Auxiliary switch for RCCBs 125A (OFSP)	0.5	16940	1850

### Accessories



Type	Description	Reference	Unit LP [₹]
Rotary Handle*	Breaker Switching Sub-Assembly	27046	3405
	Extended, Disconnectable handle	27047	2105
Padlock** (bag of 2)		26970	818
Aluminum cable terminal**		27060	496
Spacer		A9N27062	208

\* for xC60, C120, DPN N Vigi, C60H-DC, xSW - Multi poles only

\*\*for xC60, xID, DPN N Vigi, C60H-DC, xSW, C60PV-DC

**Note:** For all above Reference MOQ = 1

# Protection Against Lightning Strikes And Switching Surges



For all low voltage switchboards and electrical enclosures:

## Comprehensive range

- To ensure the protection of equipment connected to:
- Low voltage networks,
- Telecommunications networks,
- Computer networks.
- Easy to implement and use.
- Compatibility with all earthing systems (TT, TNS, TNC, IT).
- Technical and aesthetic consistency

## Continuity of service and certified safety

Schneider Electric certified coordination between the surge arrester and its disconnection circuit breaker.

Compliance with standards: IEC/EN 61643-11.



More and more electrical equipment today is sensitive to overvoltages caused by lightning.



# 90%

of power outlets supply equipment incorporating electronic devices.



iQuick PRD “built-in” technology surge arresters, a Schneider Electric innovation, incorporate their own disconnection circuit breaker: easy to choose and simple to install for greater effectiveness.



Up to **30%** of installation time saved.

### Surge Arresters - Type 1+ 2



- Complies to IEC 61643-1 and EN 61643-11
- Withdrawable type: Easy Replacement
- Inbuilt SPD health Indicator: Also available with remote signaling
- For protection against Direct lightning surge, Indirect lightning surge, Switching surge
- Iimp up to 25kA & Imax upto 40kA
- **Always use a Back-up MCB with your SPD**
- Maximum Operating Voltage [Uc]: 350V

Type	Pole Description	Module Width 18mm/module	Reference	Unit LP [₹]
PRD1 25r	1P	2	16329	12385
	1P + N	4	16330	27245
	3P	6	16331	40860
	3P + N	8	16332	50765

### Surge Arresters iPRD- Type 2 (Withdrawable type) (TT, TN-S, TN-C Systems)



- In conformance with standards IEC 61643-11/2011 T2 and EN 61643-11 Type 2
- For protection against Indirect lightning surge and Switching surge
- Inbuilt health Indicator
- Response time < 25ns
- Imax (8/20 s): 65/40/15/8kA
- Maximum Operating Voltage [Uc]: 340V
- Level of protection,Up: 1.0 - 2.0 kV
- Remote indication contact with 8r/20r/40r/65r
- **Always use a Back-up MCB with your SPD**

Type	Rated Voltage (V)	Pole Description	Module Width 18mm/module	Reference	Unit LP [₹]
iPRD8	230	1P	1	A9L08100	3840
	230	1P+N	2	A9L08500	7185
	230/400	3P	3	A9L08300	9700
	230/400	3P+N	4	A9L08600	14650
iPRD8r	230	1P+N	2	A9L08501	8615
	230/400	3P+N	4	A9L08601	17580
	230	1P	1	A9L20100	4310
iPRD20	230	1P+N	2	A9L20500	9035
	230/400	3P	3	A9L20300	11570
	230/400	3P+N	4	A9L20600	16675
iPRD20r	230	1P+N	2	A9L20501	10745
	230/400	3P+N	4	A9L20601	20005
	230	1P	1	A9L40100	5090
iPRD40	230	1P+N	2	A9L40500	10405
	230/400	3P	3	A9L40300	14945
	230/400	3P+N	4	A9L40600	20845
iPRD40r	230	1P	1	A9L40101	6105
	230	1P+N	2	A9L40501	13420
	230/400	3P	3	A9L40301	20120
iPRD65r	230/400	3P+N	4	A9L40601	25010
	230	1P	1	A9L65101	8165
	230	1P+N	2	A9L65501	17105
	230/400	3P	3	A9L65301	22325
	230/400	3P+N	4	A9L65601	28970

### Spare Cartridges for iPRD



- Spare Cartridges for iPRD8r, iPRD20r, iPRD40r and iPRD65r
- End of life indication available on front face
- These Cartridges are not compatible with Old SPD range (A9L16...)\*\*

Type	Spare Cartridges for	Reference	Unit LP [₹]
iPRD 65-350	iPRD65r	A9L65102	5110
iPRD 40-350	iPRD40, iPRD40r	A9L40102	3930
iPRD 20-350	iPRD20, iPRD20r	A9L20102	3145
iPRD 8-350	iPRD8, iPRD8r	A9L08102	2755
iPRD Neutral	All products (1P+N, 3P+N)	A9L00002	4135

\*\*Spare Cartridges for Old SPD Range (A9L16...) are available on demand - please contact nearest Schneider Electric Sales Office or Customer Care for Reference and prices

**Note:** Note: For all above Reference MOQ = 1



### iQuick PRD - Type 2 with inbuilt MCB



- Compact SPD with in-built back up MCB - saving on space, MCB selection, wiring time
- Compliance to EN 61643-11
- Withdrawable Type - Cost Efficient - Allows damaged Cartridges to be replaced without having to replace entire SPD
- Inbuilt SPD Health Indicator on front face of device; Remote signaling functionality also available
- Incoming Protection: iQuick PRD 40r (High Risk level) and iQuick PRD 20r (Moderate Risk level)
- Secondary Protection: iQuick PRD 8r is cascade mounted with incoming surge arresters

Type	Pole Description	Module Width 18mm/module	Reference	Unit LP [₹]
iQuick PRD 8r	1P+N	4	A9L16298	10380
	3P	6.5	A9L16299	15250
	3P+N	7.5	A9L16300	18980
iQuick PRD 20r	1P+N	4	A9L16295	12450
	3P	6.5	A9L16296	18305
	3P+N	7.5	A9L16297	22775
Quick PRD 40r	1P+N	4	A9L16292	14540
	3P	6.5	A9L16293	21790
	3P+N	7.5	A9L16294	27080

**Note:** Spare / Replacement Cartridges available - For Reference and prices contact nearest sales office or customer care

### Photovoltaic surge arresters



- Protection for photovoltaic panels and the DC input to the inverter from overvoltages due to a lightning strike
- Type 2 surge arresters
- Should be installed in switchboard inside the building. If switchboard is located outside, it must be weatherproof
- Withdrawable surge arrester allows damaged Cartridges to be replaced quickly
- Inbuilt SPD Health Indicator on front face of device; Remote signaling functionality also available

Type	U (cpv) Maximum Operating Voltage (V)	Module Width 18mm/module	Reference	Unit LP [₹]
iPRD 40r	800	3	A9L40271	8565
	1000	3	A9L40281	9785

**Note:** Spare / Replacement Cartridges available - For Reference and prices contact nearest sales office or customer care

### Surge Arresters for Communication Networks



- Analogue telephone line protection: iPRC surge arrester wired in series to the private installation input, protects the telephones, the modems (including ADSL) etc
- Protection for 2 low-current lines without common potential or 4 lines with common reference potential
- iPRI protects measuring instrument and PLC sensor inputs and the DC power supply inputs up to 53 V and AC power supply inputs up to 37 V

Type	[Ue] Operational Voltage (V)	Module Width 18mm/module	Reference	Unit LP [₹]
PRI	48 V DC	1	A9L16339	14770
PRC	130 V AC	1	A9L16337	9035

**Note:** For all above Reference MOQ = 1

Please contact Customer Care Center for Stockable and Non stockable status of references.

NORMAL STOCK ITEMS

W.E.F. March 12, 2018

### Isolator - xSW



- Complies to IEC/EN 60947-3
- Switching duty: AC-22
- Impulse voltage: 6kV
- DC application: 48V (110V with 2 poles in series)
- Short circuit withstand 20 In for 1 second
- Upto 80A Bi connect terminals & 100A to 125A with mono connect terminals

Poles Description	[In] Rated Current (A)	Module Width 18mm/module	MOQ	Reference	Unit LP [₹]
2	40	2	6	A9S2P040	554
	63	2	6	A9S2P063	732
	80	2	6	A9S2P080	880
	100	2	6	A9S2P100	1275
	125	2	6	A9S2P125	1315
3	40	3	4	A9S3P040	974
	63	3	4	A9S3P063	1140
4	40	4	3	A9S4P040	1230
	63	4	3	A9S4P063	1345
	80	4	3	A9S4P080	1785
	100	4	3	A9S4P100	2005
	125	4	3	A9S4P125	2170

### Selector Switch - iSSW



- Complies to IEC 60947-5-1 and IEC 60669-1
- Rating 20A, 250V AC
- Electrical life (AC22): 30,000 cycles
- Connection: tunnel terminals cables up to 10 sq. mm

No. of positions	Poles Description	Contacts	Module Width 18mm/module	MOQ	Reference	Unit LP [₹]
2	1	1 C/O	1	12	A9E18070	1145
	2	2 C/O	2	6	A9E18071	1580
		1NO + 1NC	1	12	A9E18072	918
3	1	1 C/O	1	12	A9E18073	1125
	2	2 C/O	2	6	A9E18074	1905

### iRO Buzzers



- Audible indication in housing and the tertiary sector
- Sound level of 70dBA at a distance of 60cm

Voltage	Module Width 18mm/module	Reference	Unit LP [₹]
230V AC	1	A9A15322	972
8..12V AC	1	A9A15323	814

### iCT Contactors



- Complies with standards IEC 1095, E N 61095
- 4 operating modes switch on front face :
  - Automatic mode
  - Temporary "ON" mode
  - Permanent "ON" mode
  - Shutdown
- Mechanical contact position Indicator
- Safe installation maintenance: lock the contactor in ON position
- Silent operation (20dB) for entire range

Type	Rating (A)	No. of Contacts	Module Width 18mm/module	Reference	Unit LP [₹]
1P	25	1NO	1	A9C20731	1775
	16	2NO	1	A9C22712	1825
2P	25	2NO	1	A9C20732	2185
	40	2NO	2	A9C20842	3740
	63	2NO	2	A9C20862	4780
3P	25	3NO	2	A9C20833	2770
	40	3NO	2	A9C20843	6255
	63	3NO	3	A9C20863	6800
4P	25	4NO	2	A9C20834	2945
	40	4NO	2	A9C20844	6380
	63	4NO	3	A9C20864	7690
	63	2NO + 2NC	3	A9C20868	7690

**Note:** 100A Contactor in 2P / 4P - available on request

### iTL Impulse Relays



- Complies with standards IEC/EN 60669-2-2
- Safe maintenance: disconnection of remote control by selector switch
- Manual Controls on front face: 0-I toggle
- Mechanical contact position Indicator
- Maximum 5 operations/min. and 100 switching operations/day
- Degree of pollution: 3 (suitable for industrial environment)

Type	Rating (A)	Control Voltage	No. of Contacts	Module Width	Reference	Unit LP [₹]
1P	16	230-240 VAC	1NO	1	A9C30811	1145
	32	230-240 VAC	1NO	1	A9C30831	1440
2P	16	230-240 VAC	2NO	1	A9C30812	1885
	32	230-240 VAC	2NO	1	A9C30831 + A9C32836	4470
3P	16	230-240 VAC	1NO+1NO/NC+1NO	2	A9C30811 + A9C32816	3575
	32	230-240 VAC	1NO+1NO/NC+1NO	2	A9C30831 + 2 x A9C32836	4470
4P	16	230-240 VAC	4NO	2	A9C30814	3910
	32	230-240 VAC	4NO	2	A9C30831 + 3 x A9C32836	4470

### iIL Indicator Lights



- Complies with standard IEC 60947-5-1
- Indicator light with LED technology
- Service life 100,000 hours with constant luminous efficiency

Type	Colour	Module Width 18mm/module	Reference	Unit LP [₹]
Single Indicator light	Red	1	A9E18320	1075
	Green	1	A9E18321	1075
	Blue	1	A9E18323	1075
	Orange	1	A9E18324	1075
3 phase voltage presence light	Red/Red/Red	1	A9E18327	2695
Single Push Button (1 NO+ 1NC)	Grey	1	A9E18033	1600

**Note:** For all above Reference MOQ = 1

Please contact Customer Care Center for Stockable and Non stockable status of references.

NORMAL STOCK ITEMS

W.E.F. March 12, 2018

## PowerTag - World's smallest energy sensor



### Monitor Your Energy

- Real time U, V, I, P, PF
- Active energy metering (Class 1 EN 61557-12) partial and total
- Load balance overview for 3P

### Improve your Maintenance

- Pre Alarm on overload
- Specific "alarms" for U, I, P
- Alarm on feeder voltage loss

Description	Part no.	Unit LP [₹]
PowerTag 1P	A9MEM1520	7145
PowerTag 1P+N Up	A9MEM1521	7145
PowerTag 1P+N Down	A9MEM1522	7145
PowerTag 3P	A9MEM1540	14285
PowerTag 3P+N Up	A9MEM1541	14285
PowerTag 3P+N Down	A9MEM1542	14285
Smartlink SI-D	A9XMWA20	19950
Smartlink SI-B	A9XMZA08	38805

## Smartlink



- Compliance to IEC/EN 61131-2
- Protection Monitoring – Device Status and alarm notifications
- Load Control / Switching through Contactors and Impulse Relays
- Energy Monitoring through pulse meters
- Alarm over email and analog sensors (temperature / humidity) with Smartlink Ethernet
- Plug & Play – Pre fabricated cables and in built web pages
- Rated Voltage: 24V DC

Description	Reference	Unit LP [₹]
Smartlink Modbus	A9XMSB11	33170
Smartlink IP	A9XMEA08	36955

## Communication Auxiliaries



Auxiliary for Protection Devices (OF+SD24)



Auxiliary for Contactors (iACT24)



Auxiliary for Impulse Relays (iATL24)

Description	Module Width	Reference	Unit LP [₹]
OF+SD24	0.5	A9N26899	2390
iACT24	1	A9C15924	11900
iATL24	1	A9C15424	12530

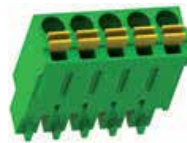

Description	Set of	Reference	Unit LP (₹)
<b>Prefabricated Cables:</b>			
<b>With 2 Connectors</b>			
Short: 100mm	6	A9XCAS06	4840
Medium: 160mm	6	A9XCAM06	4890
Long: 870mm	6	A9XCAL06	5560
<b>With 1 Connector</b>			
Long:870mm	6	A9XCAU06	3340
<b>Connectors</b>			
5-pin connectors (Ti24)	12	A9XC2412	6735
<b>Mounting Kit</b>			
Din Rail (4 feet, 4 Straps, 4 Adapters)	1	A9XMFA04	1320
<b>Multiclip</b>			
Multiclip 80A	1	4000	8100
<b>Spare Parts</b>			
Lock for Multiclip 80A (2 clips)	1	A9XMLA02	402
<b>Distribloc 63A</b>			
Distribution from the top (4 Module)	1	4040	9225
Distribution through the bottom (4 Module)	1	4041	9225
Power Logic EGX300 - Ethernet port (4 Module)	1	30002885	28213
ABL Power Supply - 1.2A 24VDC	1	ABL8MEM24012	6400
ABL Power Supply - 0.6A 24VDC	1	ABL8MEM24006	4700
Double DIN rail	1	LSL58801A	725

## Reflex iC60 - Integrated Control & Overcurrent Protection Device



- All in One Solution: MCB + Contactor + Impulse Relay + Auxiliary
- 10kA Breaking capacity as per IEC/EN 60947-2,
- Ti24 interface: Connection to PLC, Smartlink
- 3 operating modes to cater to a variety of applications
- Safe lock down with Integrated Padlocking
- Simplified maintenance: Front face Indicator allows better reliability

[In] Rated Current (A)	2 Pole Reference	Unit LP (₹)	3 Pole Reference	Unit LP (₹)	4 Pole Reference	Unit LP (₹)
Module Width **	4.5 mod		5.5 mod		6.5 mod	2275
<b>B Curve</b>						
10	A9C61210	32740	A9C61310	35235	A9C61410	36655
16	A9C61216	32760	A9C61316	35265	A9C61416	36705
25	A9C61225	32795	A9C61325	35335	A9C61425	36775
40	A9C61240	34855	A9C61340	38400	A9C61440	40875
63	A9C61263	36060	A9C61363	39150	A9C61463	41135
<b>C Curve</b>						
10	A9C62210	32745	A9C62310	35240	A9C62410	36670
16	A9C62216	32760	A9C62316	35265	A9C62416	36705
25	A9C62225	32795	A9C62325	35320	A9C62425	36780
40	A9C62240	34865	A9C62340	38420	A9C62440	40900
63	A9C62263	36055	A9C62363	39150	A9C62463	41140
<b>D Curve</b>						
10	A9C63210	32745	A9C63310	35240	A9C63410	36670
16	A9C63216	32760	A9C63316	35260	A9C63416	36705
25	A9C63225	32795	A9C63325	35335	A9C63425	36780

Note: \*\*18mm/module

LP: List Price

Please contact Customer Care Center for Stockable and Non stockable status of references.

NORMAL STOCK ITEMS

W.E.F. March 12, 2018

### Energy Meters



- Digital Kilowatt-hour meters designed for sub-metering of active energy (rms) consumed by a single-phase or three-phase electric circuit with or without distributed neutral
- ComReady DB mountable version
- Accuracy class-1
- No External CT required

Description	Reference	Unit LP [₹]
iEM 2000T 1Ph Energy Meter upto 40A, POP w/o Display	A9MEM2000T	4487
iEM3110 3 Phase Energy Meter Energy Meter with POP Accuracy CL 1.0	A9MEM3110	10817
iEM3150 3 Phase Energy Meter Energy Meter with V,I,Power, Accuracy CL 1.0, with Modbus	A9MEM3150	11816
iEM3155 Multifunction 3 Phase Energy Meter with V,I,F,PF,Power, Energy,1DI/1DO, Multi Tariff, with Modbus Accuracy CL 1.0	A9MEM3155	12519

**Note:** For Higher Currents /Loads , Select iEM32 Series , CT Operated , Accuracy CL 0.5S

# Acti 9

## Distribution Boards

### Spectacular Design

*Blends seamlessly with interiors*



Unique Rounded Corners | Color - RAL 9003 white | Designer Rotary Knob

### Maximized Wiring Space

*Convenient and Safe wiring*

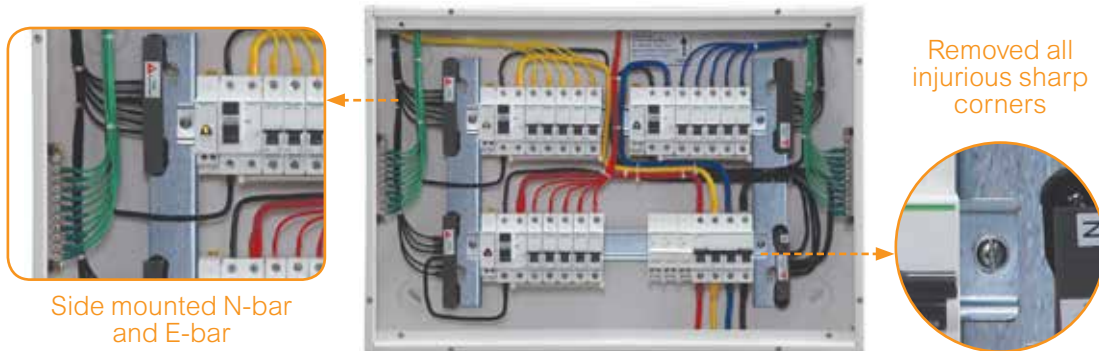

15% more wiring area | Reduced U-box Collar | Removable Frame, Centre plate & Gland plate

### Adaptable

*Total Flexibility for ease of installation and usage*



Surface and Flush installation | Field fittable key lock provision | Reversible Door

Inspiring the **S.M.A.R.T.** choice!!!

## Robust Architecture

*Perfect blend of Strength & Weight*



High Strength-to-Weight ratio | RoHS and REACH Compliance – ideal solution for GREEN Buildings

## Technically Proven

*Safety Guaranteed*



Designed and Manufactured as per IS 8623 - 1&3 | IP and IK test by ERDA & CPRI | Glow wire tested





# Acti 9

## Distribution Boards

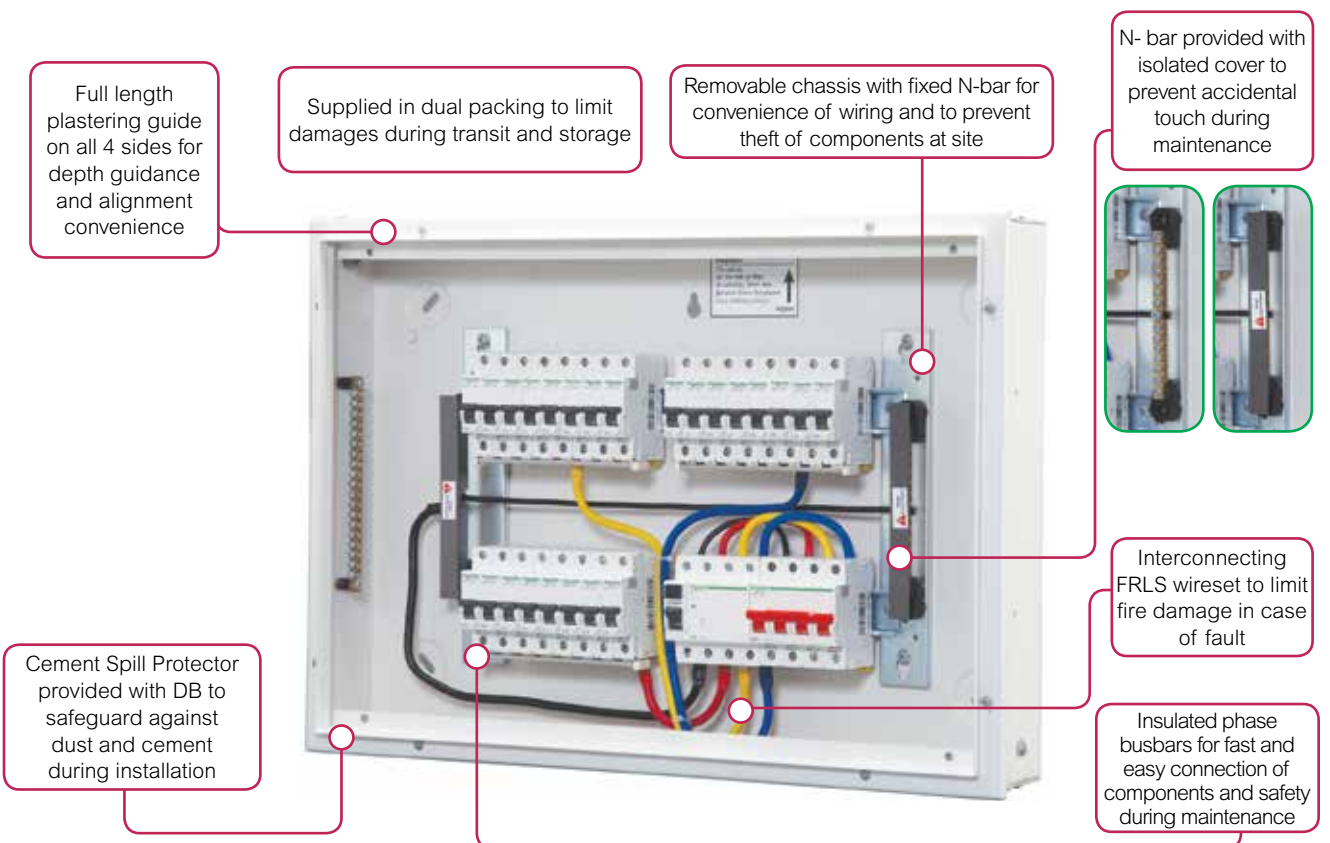
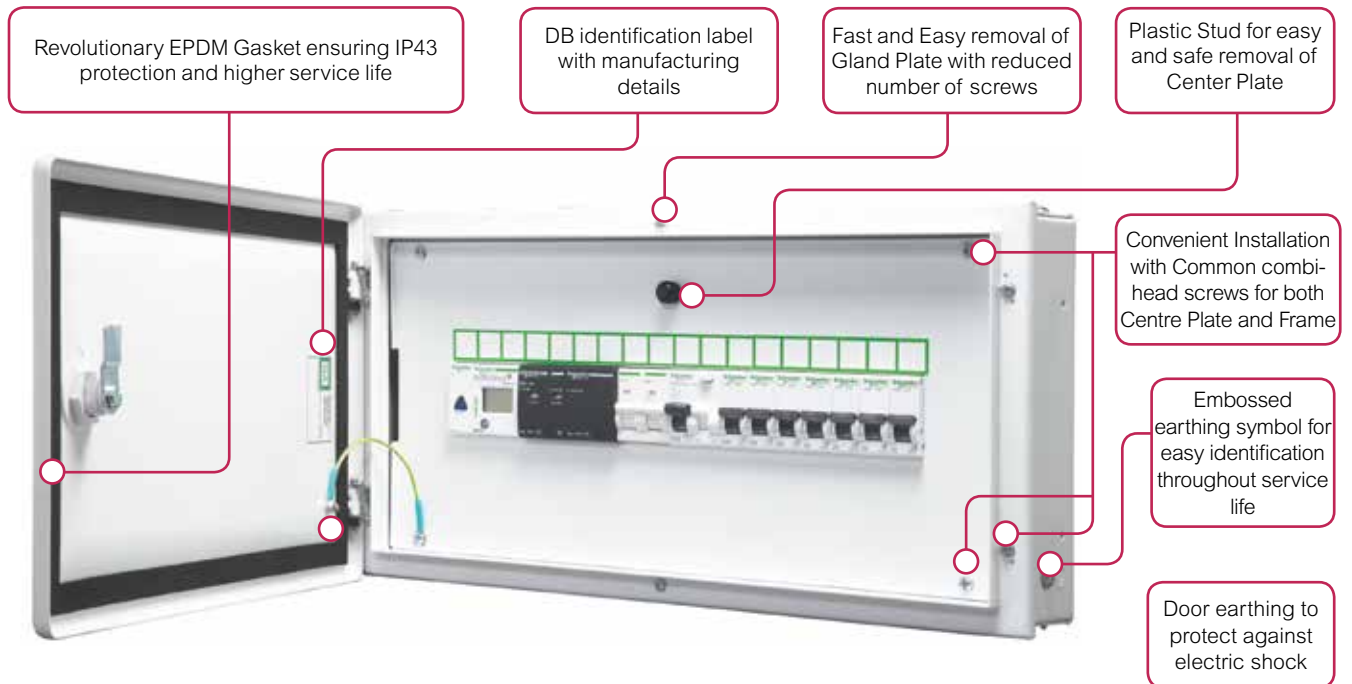

### Metal Enclosures



- Metal Enclosure to mount individual Modular Device feeding directly to the load or final distribution board

Description	Total Module Cutout	Single Door (IP30) Reference	Unit MRP [₹]	Double Door Metal (IP43) Reference	Unit LP [₹]
2 way	1 / 2	A9HMES02 <input checked="" type="checkbox"/>	684	-	-
4 way	3 / 4	A9HMES04 <input checked="" type="checkbox"/>	684	-	-

### SPN DBs



- SPN DB for distribution of Single Phase Neutral supply to respective load MCBs
- Incomer - DP RCCB/RCBO/Isolator/MCB
- Outgoing - SP MCBs

Description	Total Module Cutout (Incomer + Outgoing)	Single Door (IP30) Reference	Unit MRP [₹]	Double Door Metal (IP43) Reference	Unit LP [₹]
6 way	6	A9HSNS06	1330	A9HSND06 <input checked="" type="checkbox"/>	1910
8 way	8	A9HSNS08 <input checked="" type="checkbox"/>	1650	A9HSND08 <input checked="" type="checkbox"/>	2185
12 way	12	A9HSNS12	1955	A9HSND12 <input checked="" type="checkbox"/>	2625
18 way	18	A9HSNS18	2575	A9HSND18 <input checked="" type="checkbox"/>	3365

### TPN DBs



- Standard TPN DBs for distribution of Three Phase and Neutral supply
- Incomer - FP RCCB/RCBO/Isolator/MCB
- Outgoing - SP MCBs
- TPN DBs can be converted to PPI DB using 'PPI Kit' provided on next page

Description	Total Module Cutout (Incomer + Outgoing)	Single Door (IP30) Reference	Unit MRP [₹]	Double Door Metal (IP43) Reference	Unit MRP [₹]
4 way eco	4 + 12	-	-	A9HTND04E <input checked="" type="checkbox"/>	4100
4 way	8 + 12	A9HTNS04	3630	A9HTND04 <input checked="" type="checkbox"/>	4305
6 way	8 + 18	A9HTNS06	4475	A9HTND06 <input checked="" type="checkbox"/>	5305
8 way	8 + 24	A9HTNS08	5260	A9HTND08 <input checked="" type="checkbox"/>	6370
12 way	8 + 36	A9HTNS12	7795	A9HTND12 <input checked="" type="checkbox"/>	9555

### Flexi Tier DBs



- Flexi DBs give total flexibility to mount any type and size of Modular devices as per load requirement
- Provided with N-Bar and E-Bar
- Flexi Tier DBs can be converted to PPI DB using 'PPI Kit' provided on next page

Description	Total Module Cutout (Incomer + Outgoing)	Single Door (IP30) Reference	Unit MRP [₹]	Double Door Metal (IP43) Reference	Unit LP [₹]
2 Tier 24 Modules	2 x 12	-	-	A9HFD224	5405
3 Tier 36 Modules	3 x 12	-	-	A9HFD336	6495
4 Tier 40 Modules	4 x 10	-	-	A9HFD440 <input checked="" type="checkbox"/>	6865
4 Tier 56 Modules	4 x 14	-	-	A9HFD456 <input checked="" type="checkbox"/>	7175

**Note:** For all above Reference MOQ = 1

### Per Phase Isolation DBs

- PPI DBs to mount DP Residual Current Device (RCD) at an individual phase level to isolate the faulty phase in case of earth leakage and ensure continuity of supply to other healthy phases
- Incomer - Modular (FP MCB/Isolator) using PPI Kit / MCCB100A (TP/FP Compact NSX or EasyPact CVS)
- Sub-Incomer - DP RCCB/RCBO
- Outgoing - SP MCBs

Description	Total Module Cutout (Incomer + Outgoing)	Single Door (IP30) Reference	Unit MRP [₹]	Double Door Metal (IP43) Reference	Unit LP [₹]
12 way	100A MCCB + 6 + 36	-	-	A9HPID12M	14310

### PPI Kit (to convert TPN and Flexi Tier DBs to PPI DB)



- Set of accessories to convert TPN DBs and 4 tier Flexi DBs to PPI DB
- Kit is provided with additional required quantity of N-Bar, wire set, Busbars (only for Flexi Tier) and Mounting Kit (only for TPN)

Description	Reference	Unit LP [₹]
PPI Kit for 6way TPN DB (2+4w PPI DB)	A9HKIT04 <input checked="" type="checkbox"/>	2780
PPI Kit for 8way TPN DB (2+6w PPI DB)	A9HKIT06 <input checked="" type="checkbox"/>	3255
PPI Kit for 12way TPN DB (2+10w PPI DB)	A9HKIT10 <input checked="" type="checkbox"/>	3590
PPI Kit for 4T40M Flexi DB (2+8w PPI DB)	A9HKIT08 <input checked="" type="checkbox"/>	5765
PPI Kit for 4T56M Flx DB (2+12w PPI DB)	A9HKIT12 <input checked="" type="checkbox"/>	6380

### Phase Segregated DBs



- Phase Segregated DBs to provide total safety for installer and maintenance personnel, by compartmentalizing each Phase and separating Incomer, Sub-Incomer and Outgoing
- Offers better continuity of supply in case of faults during maintenance at DB level.
- Incomer - Modular (FP MCB/Isolator) / MCCB 100A (TP/FP during maintenance Compact NSX or EasyPact CVS)
- Sub-Incomer - DP RCCB/RCBO
- Outgoing - SP MCBs

Description	Total Module Cutout (Incomer + Sub-incomer + Outgoing)	Single Door (IP30) Reference	Unit MRP [₹]	Double Door Metal (IP43) Reference	Unit LP [₹]
6 way	8 + 12 + 18	-	-	A9HPGD06 <input checked="" type="checkbox"/>	12710
8 way	8 + 12 + 24	-	-	A9HPGD08 <input checked="" type="checkbox"/>	14195
12 way	8 + 12 + 36	-	-	A9HPGD12	17820
12 way with MCCB I/c	100A MCCB + 12 + 36	-	-	A9HPGD12M	24050

### VTPN DBs for Modular Incomer



- Ideal solution to distribute power supply to both 3 Phase and 1 Phase loads in the same DB
- Incomer - FP RCCB/RCBO/Isolator/MCB
- Outgoing - SP MCBs / TP MCBs

Description	Total Module Cutout (Incomer + Outgoing)	Single Door (IP30) Reference	Unit MRP [₹]	Double Door Metal (IP43) Reference	Unit LP [₹]
4 way	8 + 12	-	-	A9HVTD04 <input checked="" type="checkbox"/>	10655
8 way	8 + 24	-	-	A9HVTD08 <input checked="" type="checkbox"/>	13555
12 way	8 + 36	-	-	A9HVTD12 <input checked="" type="checkbox"/>	18145

**Note:** For all above Reference MOQ = 1

Please contact Customer Care Center for Stockable and Non stockable status of references.

NORMAL STOCK ITEMS

W.E.F. March 12, 2018

### VTPN DBs for MCCB Incomer



- DBs for higher incoming current distribution up to 250A
- Incomer - TP/FP Compact NSX or EasyPact CVS MCCB up to 250A
- Outgoing - SP MCBs / TP MCBs

Description	Total Module Cutout (Incomer + Outgoing)	Single Door (IP30) Reference	Unit MRP [₹]	Double Door Metal (IP43) Reference	Unit LP [₹]
4 way	100A MCCB + 12	-	-	A9HVD04L	11670
8 way	100A MCCB + 24	-	-	A9HVD08L	14790
12 way	100A MCCB + 36	-	-	A9HVD12L	19670
4 way	160A MCCB + 12	-	-	A9HVD04M	12845
8 way	160A MCCB + 24	-	-	A9HVD08M	16005
12 way	160A MCCB + 36	-	-	A9HVD12M	21365
8 way	250A MCCB + 24	-	-	A9HVD08H	27665
12 way	250A MCCB + 36	-	-	A9HVD12H	29165

### ComReady DBs



- Designed to house Acti 9 communication system
- Supplied with Double DIN rail, E-Bar and Wire channel.
- Accessories to convert Flexi Tier DB into ComReady DB available on request

Description	Total Module Cutout (Incomer + Outgoing)	Single Door (IP30) Reference	Unit MRP [₹]	Double Door Metal (IP43) Reference	Unit LP [₹]
1 Tier 24 Modules	24	-	-	A9HCRD124	7235
2 Tier 48 Modules	48	-	-	A9HCRD248	11725

### Metal Clad P&S Units



- Plug & Socket Unit with Electra Plug & Socket and provision to mount modular protection devices to feed the end load directly

Description	Total Module Cutout	Single Door (IP30) Reference	Unit MRP [₹]	Double Door Metal (IP43) Reference	Unit LP [₹]
10A 1P+N+E P&S	2	A9HMS210	1750	-	-
20A 1P+N+E P&S	2	A9HMS220	1875	-	-
30A 3P+E P&S	3	A9HMS330	4105	-	-

### Industrial P&S Units (provision to mount PratiKa Sockets)



- Plug & Socket Unit with provision to mount PratiKa straight / angled\* socket and modular protection devices to feed the end load directly

Description	Total Module Cutout	Single Door (IP30) Reference	Unit MRP [₹]	Double Door Metal (IP43) Reference	Unit LP [₹]
16A 3P PK P&S	2	A9HKS316	1615	-	-
32A 3P PK P&S	2	A9HKS332	2675	-	-
32A 5P PK P&S	4	A9HKS532	3170	-	-
63A 5P PK P&S	4	A9HKS563	6405	-	-

\*upto 32A socket only

**Note:** For all above Reference MOQ = 1

## Locks for Acti 9 DBs



Key Lock

Description	Reference	Unit LP [₹]
Rotary lock	A9HRL801	438
Key Lock	A9HRL802	522

## Accessories for Distribution Boards

Description	Reference	Unit LP [₹]
<b>Busbars</b>		
Fork Busbar 1P 12MOD. 63A	R9XFH112	568
Fork Busbar 1P 57MOD. 63A	R9XFH157	1295
Fork Busbar 2P 12MOD. 63A	R9XFH212	668
Fork Busbar 2P 57MOD. 63A	R9XFH257	2485
Fork Busbar 3P 12MOD. 63A	R9XFH312	998
Fork Busbar 3P 57MOD. 63A	R9XFH357	5435
Fork Busbar 4P 12MOD. 63A	R9XFH412	1295
Fork Busbar 4P 57MOD. 63A	R9XFH457	5695
<b>Busbar Accessories</b>		
Set of 10 End Caps 1P	R9XE110	490
Set of 10 End Caps 2P	R9XE210	490
Set of 10 End Caps 3P	R9XE310	594
Set of 10 End Caps 4P	R9XE410	616
Set of 4 Connector Fork 63A	R9XFC04	472
Set of 20 Tooth Caps	R9XT20	760
Blanking Plate	13229B	28

**Note:** Blanking Plate MOQ = 10, All other MOQ = 1

Customized Distribution Boards to Suit Your Need -  
Available on Request\*

- TV/Telephone DBs
- Pre-Wired DBs
- 8 Segment DBs
- Acrylic Door DBs
- IP54/55 DBs
- DBs with Phase Indication Lamps

Acti 9K NEW

- Superior finish to blend with common wall shades
- Ergonomic door knob
- Tested as per IEC 61439 at NABL Accredited Labs
- Flexible installation and reversible door
- Comprehensive offer

Product Ref No. (Min 3, Max 18 characters) (Mandatory)	Short Product Description (Max 40 characters) (Mandatory)	Unit LP [₹]
A9KESNS04	Acti 9K DB 4 way SPN Single Door	916
A9KESNS06	Acti 9K DB 6 way SPN Single Door	1130
A9KESNS08	Acti 9K DB 8 way SPN Single Door	1220
A9KESNS12	Acti 9K DB 12 way SPN Single Door	1512
A9KESND04	Acti 9K DB 4 way SPN Double Door	1486
A9KESND06	Acti 9K DB 6 way SPN Double Door	1581
A9KESND08	Acti 9K DB 8 way SPN Double Door	1806
A9KESND12	Acti 9K DB 12 way SPN Double Door	2172
A9KESND16	Acti 9K DB 16 way SPN Double Door	2785
A9KETNS04	Acti 9K DB 4 way TPN Single Door	2825
A9KETNS06	Acti 9K DB 6 way TPN Single Door	3485
A9KETNS08	Acti 9K DB 8 way TPN Single Door	4092
A9KETND04E	Acti 9K DB TPN 4 way Double Door 4-mod I/C	3205
A9KETND04	Acti 9K DB TPN 4 way Double Door	3562
A9KETND06	Acti 9K DB TPN 6 way Double Door	4386
A9KETND08	Acti 9K DB TPN 8 way Double Door	5266
A9KETND12	Acti 9K DB TPN 12 way Double Door	7901

\*Please contact nearest Schneider Electric Sales Office for Drawings, Reference and Prices

Please contact Customer Care Center for Stockable and Non stockable status of references.

NORMAL STOCK ITEMS

W.E.F. March 12, 2018

# NeoBreak Distribution Boards

## Metal Enclosure

- Zero Error Installation
- IP 43 for Double Door, IP 30 for Single Door
- Independent intermittent shield

Voltage	Total Modules I/C + O/G	Reference	Unit MRP [₹]
1 way	1	NBKPM1 <input checked="" type="checkbox"/>	444
2 way	2	NBKPM2 <input checked="" type="checkbox"/>	444
3 way	3	NBKPM3 <input checked="" type="checkbox"/>	500
4 way	4	NBKPM4 <input checked="" type="checkbox"/>	500

## SPN DBs



Description	Total Modules I/C + O/G	Door Type	Reference	Unit MRP [₹]
SPN 4 way	4	Double door	NBKRENSNDD04 <input checked="" type="checkbox"/>	1505
SPN 6 way	6	Double door	NBKRENSNDD06 <input checked="" type="checkbox"/>	1670
SPN 8 way	8	Double door	NBKRENSNDD08 <input checked="" type="checkbox"/>	1805
SPN 12 way	12	Double door	NBKRENSNDD12 <input checked="" type="checkbox"/>	2195
SPN 16 way	16	Double door	NBKRENSNDD16 <input checked="" type="checkbox"/>	2985
SPN 4 way	4	Single door	NBKRENSNSD04 <input checked="" type="checkbox"/>	976
SPN 6 way	6	Single door	NBKRENSNSD06 <input checked="" type="checkbox"/>	1205
SPN 8 way	8	Single door	NBKRENSNSD08 <input checked="" type="checkbox"/>	1300
SPN 12 way	12	Single door	NBKRENSNSD12 <input checked="" type="checkbox"/>	1535
SPN 16 way	16	Single door	NBKRENSNSD16 <input checked="" type="checkbox"/>	1910

## TPN DBs



Description	Total Modules I/C + O/G	Door Type	Reference	Unit MRP [₹]
TPN 4 way	4+12	Double door	NBKRENTHDD04 <input checked="" type="checkbox"/>	3660
TPN 6 way	4+18	Double door	NBKRENTHDD06 <input checked="" type="checkbox"/>	4600
TPN 8 way	4+24	Double door	NBKRENTHDD08 <input checked="" type="checkbox"/>	5745
TPN 12 way	4+36	Double door	NBKRENTHDD12 <input checked="" type="checkbox"/>	8710
TPN 4 way	4+12	Single door	NBKRENTHSD04	2795
TPN 6 way	4+18	Single door	NBKRENTHSD06	3555
TPN 8 way	4+24	Single door	NBKRENTHSD08	4255
TPN 12 way	4+36	Single door	NBKRENTHSD12	6160

**Note:** For all above Reference MOQ = 1

# NeoBreak Distribution Boards

## VTPN DBs for Modular Incomer



Description	Total Modules I/C + O/G	Door Type	Reference	Unit MRP [₹]
VTPN 4 way	8+12	Double door	NBKRENTVDD04	9445
VTPN 8 way	8+24	Double door	NBKRENTVDD08	11830
VTPN 12 way	8+36	Double door	NBKRENTVDD12	15870
VTPN 4 way	8+12	Single door	NBKRENTVSD04	7195
VTPN 8 way	8+24	Single door	NBKRENTVSD08	9880
VTPN 12 way	8+36	Single door	NBKRENTVSD12	13100

## VTPN DBs for MCCB Incomer ( Suitable for 3P 100A Easypact EZC MCCB)

Description	Total Modules I/C + O/G	Door Type	Reference	Unit MRP [₹]
VTPN 4 way	MCCB +12	Double door	NBKRENEZVDD04	10745
VTPN 8 way	MCCB +24	Double door	NBKRENEZVDD08	13025
VTPN 12 way	MCCB +36	Double door	NBKRENEZVDD12	17120

## Metal Clad P&S Units



Description	Total Modules I/C + O/G	Reference	Unit MRP [₹]
10A SP Plug & Socket	1	NBKRENPSPP10 <input checked="" type="checkbox"/>	1165
20A SP plug & Socket	1	NBKRENPSPP20 <input checked="" type="checkbox"/>	1440
20A SPN Plug & Socket	2	NBKRENPSNN20 <input checked="" type="checkbox"/>	1500
20A TP Plug & Socket	3	NBKRENPTPP20 <input checked="" type="checkbox"/>	2870
30A TP Plug & Socket	3	NBKRENPTPP30 <input checked="" type="checkbox"/>	3405

**Note:** For all above Reference MOQ = 1

Please contact Customer Care Center for Stockable and Non stockable status of references.

NORMAL STOCK ITEMS

W.E.F. March 12, 2018

Kaedra enclosures for PratiKa industrial sockets are part of a complete system of Watertight enclosures from 16A to 125A providing solutions for protection, control and electrical distribution for tertiary and industrial applications



- Degree of protection - IP65
- Impact strength - IK09
- Resistant to chemical and atmospheric agents, UVs etc.
- Self extinguishing class 2 insulating material
- Flame and abnormal heat resistance: 650°C
- Reversible front face for opening of door to left/right
- Combining of enclosures horizontally/vertically while still maintaining IP
- DIN channel can be positioned in 2 depths & 2 heights for cabling purpose

## Mini Enclosures for modular devices



Description	Reference	Unit LP [₹]
4 module	13441 <input checked="" type="checkbox"/>	2305
6 module	13442	2625
8 module	13443	3095
12 module	13444	4975

## Enclosures for modular devices (with terminal blocks)



Description	Reference	Unit LP [₹]
1 row 12 module	13431	5490
1 row 18 module	13432	7235
2 row 24 module	13433	8220
2 row 36 module	13434	10405
3 row 36 module	13435	10850
4 row 72 module	13437	20715

## Mini Enclosure (suitable to mount modular devices and PratiKa 16A socket)



Description	Reference	Unit LP [₹]
4 module 1 vertical opening	13175 <input checked="" type="checkbox"/>	1095
4 module 2 horizontal opening	13176	1355
4 module 3 horizontal opening	13177	1705

**Note:** For all above Reference MOQ = 1



Enclosure (suitable to mount modular devices and PratiKa 16A / 32A sockets)



Description	Reference	Unit LP [₹]
5 module 2 opening	13178 <input checked="" type="checkbox"/>	2645
8 module 4 horizontal opening	13179	3615
13 module 3 opening	13180	4780
13 module 6 opening	13181	5255
19 module 8 opening	13182	6775

## Functional Plaques



Description	Reference	Unit LP [₹]
Blank - marked for 1 socket 50x50	13135	336
Blank - marked for 1 socket 65x65 or 75x75	13137	340
Intermediate with 65x85 opening	13136	412
Intermediate with one opening for 65x85 & 90x100	13142	686

**Note:** For all above Reference MOQ = 1

Please contact Customer Care Center for Stockable and Non stockable status of references.

NORMAL STOCK ITEMS

W.E.F. March 12, 2018

## Wander Plugs



- Conforms to IEC 60309-1 & IEC 60309-2
- PK PratiKa Screw Connect: same orientation of clamp's screws
- External impact strength; IK08
- Glow wire test: 850°C

[In] Rated Current (A)	[Ue] Rated Operational Voltage (V)	Poles Description	Reference	Unit MRP [₹]
PratiKa Screw				
IP44				
16	200...250	2P + E	PKE16M423 <input checked="" type="checkbox"/>	398
	380...415	3P + E	PKE16M434 <input checked="" type="checkbox"/>	504
		3P + N + E	PKE16M435 <input checked="" type="checkbox"/>	526
32	200...250	2P + E	PKE32M423 <input checked="" type="checkbox"/>	628
	380...415	3P + E	PKE32M434	728
		3P + N + E	PKE32M435 <input checked="" type="checkbox"/>	732
IP67				
16	200...250	2P + E	PKE16M723 <input checked="" type="checkbox"/>	872
	380...415	3P + E	PKE16M734	984
		3P + N + E	PKE16M735	1050
32	200...250	2P + E	PKE32M723	1235
	380...415	3P + E	PKE32M734 <input checked="" type="checkbox"/>	1330
		3P + N + E	PKE32M735 <input checked="" type="checkbox"/>	1340
PK (63A & 125A available in IP67 only)				
63	200...250	2P + E	81378	3500
	380...415	3P + E	81382 <input checked="" type="checkbox"/>	3335
		3P + N + E	81383 <input checked="" type="checkbox"/>	3340
125	200...250	2P + E	81390	8935
	380...415	3P + E	81394	10205
		3P + N + E	81395	10205

## Small Wall Mounted Sockets



- Conforms to IEC 60309-1 & IEC 60309-2
- External impact strength: IK08
- Glow wire test: 850°C

[In] Rated Current (A)	[Ue] Rated Operational Voltage (V)	Poles Description	Reference	Unit MRP [₹]
IP44				
16	200...250	2P + E	PKF16W423	700
	380...415	3P + E	PKF16W434	810
		3P + N + E	PKF16W435	886
32	200...250	2P + E	PKF32W423	912
	380...415	3P + E	PKF32W434	1095
		3P + N + E	PKF32W435	1155
IP67				
16	200...250	2P + E	PKF16W723	1110
	380...415	3P + E	PKF16W734	1390
		3P + N + E	PKF16W735	1440
32	200...250	2P + E	PKF32W723	1385
	380...415	3P + E	PKF32W734	2025
		3P + N + E	PKF32W735	2690

**Note:** For all above Reference MOQ = 1

## Wall Mounted Sockets



- Conforms to IEC 60309 -1 & IEC 60309-2
- Rated operational voltage upto 415V
- Rated operational current upto 125A
- External impact strength: IK08
- Glow wire test: 850°C
- Available only in IP67

[In] Rated Current (A)	[Ue] Rated Operational Voltage (V)	Poles Description	Reference	Unit MRP [₹]
63	200...250	2P + E	81178	4310
	380...415	3P + E	81182	4435
		3P + N + E	81183	4500
125	200...250	2P + E	81190	15405
	380...415	3P + E	81194	15545
		3P + N + E	81195	15625

## Wander Sockets



- PK PratiKa Screw: same orientation of clamp's screws.
- PK PratiKa : 16A & 32A; IP44 & IP67
- External impact strength; IK08
- Glow wire test: 850 °C
- Conforms to IEC 60309 -1 & IEC 60309-2

[In] Rated Current (A)	[Ue] Rated Operational Voltage (V)	Poles Description	Reference	Unit MRP [₹]
PratiKa Screw				
IP44				
16	200...250	2P + E	PKF16M423 <input checked="" type="checkbox"/>	552
	380...415	3P + E	PKF16M434	638
		3P + N + E	PKF16M435	696
32	200...250	2P + E	PKF32M423 <input checked="" type="checkbox"/>	758
	380...415	3P + E	PKF32M434	922
		3P + N + E	PKF32M435 <input checked="" type="checkbox"/>	928
IP67				
16	200...250	2P + E	PKF16M723	1020
	380...415	3P + E	PKF16M734	1280
		3P + N + E	PKF16M735	1340
32	200...250	2P + E	PKF32M723	1405
	380...415	3P + E	PKF32M734	1555
		3P + N + E	PKF32M735	1570
PK (63A & 125A available in IP67 only)				
63	200...250	2P + E	81478	3810
	380...415	3P + E	81482	3845
		3P + N + E	81483	3905
125	200...250	2P + E	81490	12010
	380...415	3P + E	81494	12030
		3P + N + E	81495	12265

## Also Available on Request:

- Patented FAST connect Plugs & Sockets - innovative cabling system that enables connection without stripping the conductor and with absolutely no screws required
- Extra Low Voltage Plugs & Sockets down to 50V

Please contact nearest Schneider Electric Sales Office or Customer Care for Reference and Prices

**Note:** For all above Reference MOQ = 1

Please contact Customer Care Center for Stockable and Non stockable status of references.

NORMAL STOCK ITEMS

W.E.F. March 12, 2018

## Panel Mounted Sockets - Angled



- PK PratiKa Screw: same orientation of clamp's screws
- External impact strength; IK08
- Glow wire test: 850°C
- Conforms to IEC 60309 -1 & IEC309-2

[In] Rated Current (A)	[Ue] Rated Operational Voltage (V)	Poles Description	Reference	Unit MRP [₹]
PratiKa Screw				
IP44				
16	200...250	2P + E	PKF16F423 <input checked="" type="checkbox"/>	428
	380...415	3P + E	PKF16F434	638
		3P + N + E	PKF16F435 <input checked="" type="checkbox"/>	680
32	200...250	2P + E	PKF32F423 <input checked="" type="checkbox"/>	758
	380...415	3P + E	PKF32F434	882
		3P + N + E	PKF32F435 <input checked="" type="checkbox"/>	896
IP67				
16	200...250	2P + E	PKF16F723 <input checked="" type="checkbox"/>	804
	380...415	3P + E	PKF16F734	916
		3P + N + E	PKF16F735	928
32	200...250	2P + E	PKF32F723	1045
	380...415	3P + E	PKF32F734	1225
		3P + N + E	PKF32F735 <input checked="" type="checkbox"/>	1245
PK (63A & 125A available in IP67 only)				
63	200...250	2P + E	81278	3440
	380...415	3P + E	81282 <input checked="" type="checkbox"/>	3445
		3P + N + E	81283 <input checked="" type="checkbox"/>	3510
125	200...250	2P + E	81290	11315
	380...415	3P + E	81294	11610
		3P + N + E	81295	11665

## Panel Mounted Sockets - Straight



- PK PratiKa Screw: same orientation of clamp's screws
- External impact strength; IK08
- Glow wire test: 850°C
- Conforms to IEC 60309 -1 & IEC309-2

[In] Rated Current (A)	[Ue] Rated Operational Voltage (V)	Poles Description	Reference	Unit MRP [₹]
PratiKa Screw				
IP44				
16	200...250	2P + E	PKF16G423	484
	380...415	3P + E	PKF16G434	696
		3P + N + E	PKF16G435	728
32	200...250	2P + E	PKF32G423	768
	380...415	3P + E	PKF32G434	886
		3P + N + E	PKF32G435	958
IP67				
16	200...250	2P + E	PKF16G723 <input checked="" type="checkbox"/>	810
	380...415	3P + E	PKF16G734	916
		3P + N + E	PKF16G735	928
32	200...250	2P + E	PKF32G723	1030
	380...415	3P + E	PKF32G734	1160
		3P + N + E	PKF32G735	1205
PK (63A & 125A available in IP67 only)				
63	200...250	2P + E	81678	3425
	380...415	3P + E	81682	3480
		3P + N + E	81683	3480
125	200...250	2P + E	81690	11535
	380...415	3P + E	81694	11610
		3P + N + E	81695	11665

**Note:** For all above Reference MOQ = 1

## Sockets with Interlock Switches - for guaranteed safety of operation

- Allows closure of main switch only when the plug is fully inserted in socket - when complete mechanical & electrical connection has occurred
- Plug removal is possible only when the switch is in "off" position

## Wall Mounted Sockets with Interlock Switch Unika (w/o protection)



- Switch designed for use in AC 22A class applications
- Conforms to IEC 60309 -1 & IEC 60309-2
- Rated operational voltage upto 415V
- Rated operational current upto 32A
- External impact strength: IK08
- Available in IP44 / IP65 versions
- Glow wire test: 750°C

[In] Rated Current (A)	[Ue] Rated Operational Voltage (V)	Poles Description	Reference	Unit MRP [₹]
IP44				
16	200...250	2P + E	83031	5815
	380...415	3P + E	83035	8050
32		3P + N + E	83036	8210
	200...250	2P + E	83042 <input checked="" type="checkbox"/>	7550
	380...415	3P + E	83046	8800
		3P + N + E	83047	8895
IP65				
16	200...250	2P + E	83081	6015
	380...415	3P + E	83085	8285
32		3P + N + E	83086	8455
	200...250	2P + E	83092	7885
	380...415	3P + E	83096	9470
		3P + N + E	83097	9470

## Socket with Interlock Switch &amp; DIN Rail Isoblock (4.5 modules)



- Switch designed for use in AC- 22A class applications
- Conforms to IEC 60309 -1 & IEC 60309-2
- Provision to DIN mount 4.5 module device
- External impact strength: IK10
- Available in IP65 version
- Glow wire test: 850°C

[In] Rated Current (A)	[Ue] Rated Operational Voltage (V)	Poles Description	Reference	Unit MRP [₹]
16	200...250	2P + E	82754 <input checked="" type="checkbox"/>	7210
	380...415	3P + E	82758	8780
		3P + N + E	82759	9075
32	200...250	2P + E	83791 <input checked="" type="checkbox"/>	8535
	380...415	3P + E	83795	10105
		3P + N + E	83796	10170

## Socket with Interlock Switch &amp; DIN Rail Isoblock (6 modules)



- Switch designed for use in AC- 22A class applications
- Conforms to IEC 60309 -1 & IEC 60309-2
- Provision to DIN mount 6 module device
- External impact strength: IK10
- Available in IP65 version
- Glow wire test: 850°C

[In] Rated Current (A)	[Ue] Rated Operational Voltage (V)	Poles Description	Reference	Unit MRP [₹]
32	200...250	2P + E	82766	11265
	380...415	3P + E	82770	13205
		3P + N + E	82771	13605
63		3P + E	82782	15175
	380...415	3P + N + E	82783	15225

**Note:** For all above Reference MOQ = 1

Please contact Customer Care Center for Stockable and Non stockable status of references.

NORMAL STOCK ITEMS

W.E.F. March 12, 2018

**ELECTRA Metal Clad Plugs & Sockets are specially designed incorporating the latest safety, quality and user friendly features.**

**Construction**

- The casting is made from non-corroding die-cast aluminum alloy combining exceptional compactness with high strength
- The design/construction eliminates the possibility of mismatch in fitting of plugs in corresponding sockets
- The floating contacts in the sockets are self aligning and facilitates smooth plugging in without undue pressure (These can be easily removed for wiring )
- A provision for pilot pin facilitates mechanical interlocking in case of 63 Amp ratings

**Human Safety**

Specially designed shroud to avoid accidental finger contact with plug-pins while inserting/removing the plug  
Similarly, the contact tubes in sockets are deeply recessed to avoid human contact

- The earthing pins ensure that earth connection is made first and broken last, being longer than conducting pins
- The visible earth terminals facilitate easy checking of earth connection
- The cable grip to the plug is made very strong by providing a compression gland and by protecting it at the point of entry by a strong rubber guard

**Applications**

Industrial, Commercial & Domestic portable equipments like hand/Power tools, industrial ovens, Welding sets, Mobile generators, Furnaces, Ships, Office Machines, Refrigerators, Coolers, Air-Conditioners, Overhead cranes, Chilling cabinets, Tile polishers and Sewing Machines

**Plug**



Rating (A)	Poles Description	Voltage (V)	MOQ	Reference	Unit MRP [₹]
10	2P	250	30	AP10 <input checked="" type="checkbox"/>	188
20	2P	250	30	AP20 <input checked="" type="checkbox"/>	198
20	3P	440	30	BP20 <input checked="" type="checkbox"/>	262
30	3P	440	20	BP30 <input checked="" type="checkbox"/>	480
63	3P+N+E	440	4	CP63 <input checked="" type="checkbox"/>	2170

**Socket**



Rating (A)	Poles Description	Voltage (V)	MOQ	Reference	Unit MRP [₹]
10	2P	250	30	AS10 <input checked="" type="checkbox"/>	198
20	2P	250	30	AS20 <input checked="" type="checkbox"/>	232
20	3P	440	30	BS20 <input checked="" type="checkbox"/>	294
30	3P	440	20	BS30 <input checked="" type="checkbox"/>	508
63	3P+N+E	440	4	CS63 <input checked="" type="checkbox"/>	2300

Complete range of switches & sockets suitable for both indoor & outdoor applications like kitchens, swimming pools, landscape gardens, exterior walls and other environmentally challenged locations



56SW110LE-GY

Description	IP Rating	Reference	Unit LP [₹]
<b>Surface Switches</b>			
<b>Single Pole Switches Less Enclosure</b>			
1 Pole 250V 10A	IP66	56SW110LE-GY	2445
1 Pole 250V 16A	IP66	56SW116LE-GY	2290
1 Pole 250V 20A	IP66	56SW120LE-GY	3470
1 Pole 250V 32A	IP66	56SW132LE-GY	4100
<b>Double Pole Switches Less Enclosure</b>			
2 Pole 500V 16A	IP66	56SW216LE-GY	3960
2 Pole 500V 20A	IP66	56SW220LE-GY	3960
2 Pole 500V 32A	IP66	56SW232LE-GY	4600
2 Pole 500V 50A	IP66	56SW250LE-GY	4905
2 Pole 500V 63A	IP66	56SW263LE-GY	5390
<b>Triple Pole Switches Less Enclosure</b>			
3 Pole 500V 10A	IP66	56SW310LE-GY	3660
3 Pole 500V 16A	IP66	56SW316LE-GY	3820
3 Pole 500V 20A	IP66	56SW320LE-GY	4020
3 Pole 500V 32A	IP66	56SW332LE-GY	4690
3 Pole 500V 50A	IP66	56SW350LE-GY	5410
3 Pole 500V 63A	IP66	56SW363LE-GY	6280
<b>Four Pole Switches Less Enclosure</b>			
4 Pole 500V 20A	IP66	56SW420LE-GY	5310



66CV563-RG

Description	IP Rating	Reference	Unit LP [₹]
<b>IP66 Industrial Combination Switch Sockets with Enclosure</b>			
<b>Single Pole Switches Less Enclosure</b>			
500V, 63A with 4 pole switch and 63A 5 Pin Socket	IP66	66CV563-RG	71215
Plug Top 5 Pin 500V 63A	IP66	66P563-EO	21375
Plug Top 5 Pin 500V 63A	IP66	66P763-EO	23910

Please contact Customer Care Center for Stockable and Non stockable status of references.

NORMAL STOCK ITEMS

W.E.F. March 12, 2018



56SO532LE-GY



56SO320LE-RO

Description	IP Rating	Reference	Unit LP [₹]
<b>Surface Socket Outlets</b>			
<b>3 Pin Sockets Less Enclosure</b>			
3 Pin 250V 16A Indian Standard	IP66	56SO316RP-LE-GY-EX	2200
3 Pin 250V 20A Round Pin	IP66	56SO320LE-GY	3350
3 Pin 250V 32A Round Pin	IP66	56SO332LE-GY	3695
<b>4 Pin Sockets Less Enclosure</b>			
4 Pin 500V 20A Round Pin	IP66	56SO420LE-GY	4955
4 Pin 500V 32A Round Pin	IP66	56SO432LE-GY	5925
4 Pin 500V 40A Round Pin	IP66	56SO440LE-GY	6885
4 Pin 500V 50A Round Pin	IP66	56SO450LE-GY	9120
<b>5 Pin Sockets Less Enclosure</b>			
5 Pin 500V 10A Round Pin	IP66	56SO510LE-GY	5355
5 Pin 500V 20A Round Pin	IP66	56SO520LE-GY	5355
5 Pin 500V 32A Round Pin	IP66	56SO532LE-GY	6360
5 Pin 500V 40A Round Pin	IP66	56SO540LE-GY	9175
5 Pin 500V 50A Round Pin	IP66	56SO550LE-GY	9420



56PA420-EO

Description	IP Rating	Reference	Unit LP [₹]
<b>Plugs</b>			
<b>3 Pin Angle Plugs</b>			
3 Pin 250V 16A Indian Standard	IP66	56PA316RP-GY-EX	1735
3 Pin 250V 20A Round Pin	IP66	56PA320-EO	3470
3 Pin 250V 32A Round Pin	IP66	56PA332-EO	3970
<b>4 Pin Angle Plugs</b>			
4 Pin 500V 20A Round Pin	IP66	56PA420-EO	4230
4 Pin 500V 32A Round Pin	IP66	56PA432-EO	4400
4 Pin 500V 40A Round Pin	IP66	56PA440-EO	5175
4 Pin 500V 50A Round Pin	IP66	56PA450-EO	5225
<b>5 Pin Angle Plugs</b>			
5 Pin 500V 10A Round Pin	IP66	56PA510-EO	4155
5 Pin 500V 20A Round Pin	IP66	56PA520-EO	4155
5 Pin 500V 32A Round Pin	IP66	56PA532-EO	4800
5 Pin 500V 40A Round Pin	IP66	56PA540-EO	5080
5 Pin 500V 50A Round Pin	IP66	56PA550-EO	5200
<b>Combination Switch Socket Outlet</b>			
<b>IP66 Interlocked Switch Socket with Enclosure</b>			
4 Pin 500V 20A Round Pin	IP66	56CVI420-GY	12845
4 Pin 500V 32A Round Pin	IP66	56CVI432-GY	13765
5 Pin 500V 20A Round Pin	IP66	56CVI520-GY	15695
5 Pin 500V 32A Round Pin	IP66	56CVI532-GY	15840
5 Pin 500V 40A Round Pin	IP66	56CVI540-GY	17205





56DB2-GY



56DB4-GY

Description	IP Rating	Reference	Unit LP [₹]
<b>Adaptable Enclosures with Gear Tray</b>			
2 Gangpoints, 198X101X140mm	IP66	56DB2-GY	4330
3 Gangpoints, 294X101X140mm	IP66	56DB3-GY	5765
6 Gangpoints, 294X198X140mm	IP66	56DB6-GY	9530
9 Gangpoints, 294X294X180mm	IP66	56DB9-GY	14065
<b>Junction Boxes</b>			
1 Gangpoint, 107X101X90mm	IP66	56JB1-GY	1915
2 Gangpoints, 204X101X90mm	IP66	56JB2-GY	3170
3 Gangpoints, 300X101X90mm	IP66	56JB3-GY	4755
4 Gangpoints, 204X198X90mm	IP66	56JB4-GY	6385

Description	Module Width	Reference	Unit LP [₹]
<b>Switchgear Cover Assembly</b>			
For 1,2,3 Pole MCB with 4 Pole RCD (max. 4M Width)	4	56CB4N-GY	3765

Description	No. of Gangs	Reference	Unit LP [₹]
<b>Flush Surrounds</b>			
Flush Surround	1	56FA1-GY	1285
Flush Surround	2	56FA2-GY	1855
Flush Surround	3	56FA3-GY	2920
Flush Surround	4	56FA4-GY	2920
<b>Mounting Enclosures (Back Boxes)</b>			
101X101X63mm	1	56E1-GY-EX	862
198X101X63mm	2	56E2-GY	2010
294X101X63mm	3	56E3-GY	3285
198X198X63mm	4	56E4-GY	4230
294X198X63mm	6	56E6-GY	6760
391X198X63mm	8	56E8-GY	8875
294X294X63mm	9	56E9-GY	9870
391X391X63mm	16	56E16-GY	16080

Please contact Customer Care Center for Stockable and Non stockable status of references.

NORMAL STOCK ITEMS

W.E.F. March 12, 2018

# SWITCH TO STYLE

Perfect solutions for the perfect you

ULTi



NEO



ZENcelo



Opale



LIVIA



# Switch more than just lights. #Switch The Mood

ON / OFF

DIMMING

ALUMINIUM

ANTHRACITE

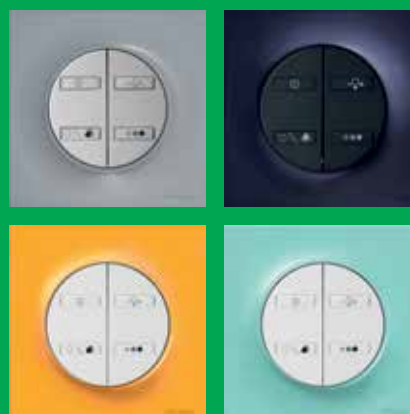

MY FAVORITE

WHITE SHADES OR  
COLOR CHANGES

## Wiser Odace™ LIGHTING. One Light, Many Moods!

White kit  
Smart LED

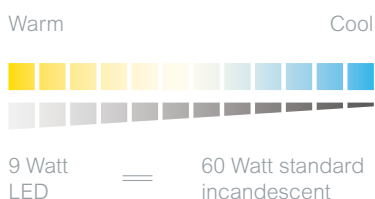

Color kit  
Smart LED  
colors

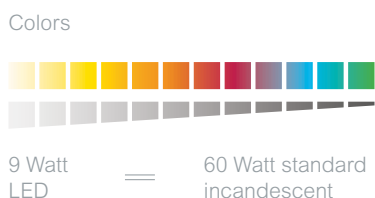

Aroma kit  
Sensorial  
light

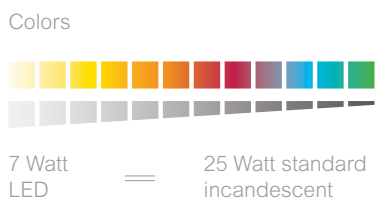

Change the mood?  
There's also an app for that!

Your mood is now at your fingertips, with the 'Wiser Lighting' app.

Bluetooth connectivity:  
Take control of the mood, wirelessly

Schedules: Set a wake-up light or a night light or presence simulator

Unlimited Colour Options:  
Choose from up to 16 million colours

Disco mode: Let your lights flash and flicker to music

Aroma diffuser: Soak in the energy of therapeutic scents

Light grouping: Several lights can be group-activated by the same preset



Wiser Odace™ LIGHTING Product	Reference	Unit MRP [₹]
White Kit	S527578W	6499
Colour Kit	S527578C	7499
Aroma Kit	S527578A	9499
White Switch	S520578	4999
Aluminium Switch	S530578	5499
Anthracite Switch	S540578	5499

\*Contact Schneider Electric Sales Representative for more details

W.E.F. March 12, 2018

# LIVIA - Switch to the extra-ordinary

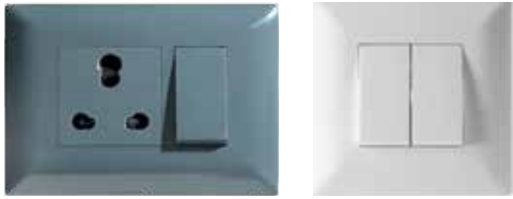

- **Sleek Design** - 2.7mm thin plate with curved body to minimize dust accumulation
- **Stylish Looks** - Soft white texture with glossy finish
- **Robust & Strong** - Innovative honeycomb designed grid plate for extra rigidity
- **Reliable** - High grade heat-resistant polycarbonate and laser marked wiring diagrams
- **Easy to Install** - Snap-In / Snap-Out front loading modules and Bigger terminal holes
- **Green & Eco Friendly** - RoHS compliant range



P1001



P1081



P1002



P1025



P2005



P2106



P3012



P3200



P6005



P5001



P0703



P0704

Description	Reference for White	Unit MRP [₹]	Reference for Pebble Grey	Unit MRP [₹]
<b>Switches</b>				
10AX 1 way switch	P1001	110	P1001_DG	132
10AX 1 way switch with Indicator lamp	P1081	182	P1081_DG	210
10AX 2 way switch	P1002	148	P1002_DG	174
16AX 1 way switch	P1101	162	P1101_DG	192
16AX 1 way switch with Indicator lamp	P1181	224	P1181_DG	260
16AX 1 way switch (2M)	P1121	230	P1121_DG	268
16AX 2 way switch (1M) <b>NEW</b>	P1102	210	P1102_DG	246
20A 1 way switch (1M) <b>NEW</b>	P11201	178	P11201_DG	196
20A DP switch with Indicator lamp	P1120	360	P1120_DG	422
32A DP switch with Indicator lamp	P1132	534	P1132_DG	628
<b>Motor Starter Switch <b>NEW</b></b>				
25A Motor Starter switch	P1186MS	850	P1186MS_DG	996
<b>Bell Push</b>				
10A Bell Push switch	P1005	164	P1005_DG	192
10A Bell Push switch (2M)	P1025	214	P1025_DG	250
10A bell push switch with Indicator	P1085	194	P1085_DG	226
10A bell push switch with Indicator (2M)	P1086	250	P1086_DG	292
<b>Sockets</b>				
10A, 2/3pin Socket Outlet with Shutter	P2005	180	P2005_DG	212
10A/16A 3-pin Socket Outlet with Shutter	P2106	272	P2106_DG	318
10A/25A 3 Pin Socket Outlet with Shutter	P2207	366	P2207_DG	430
13A Multi Pin Socket Outlet with Shutter	P2010	294	P2010_DG	352
<b>Fan Regulators &amp; Dimmers</b>				
Step type fan regulator ( 1M)	P3100	504	P3100_DG	592
Step type fan regulator ( 2M)	P3200	608	P3200_DG	714
Dimmer 400W (1M)	P3004	872	P3004_DG	1050
Dimmer 1000W (2M)	P3012	1140	P3012_DG	1335
<b>Accessories</b>				
RJ 11 Telephone outlet with shutter	P4011	146	P4011_DG	174
RJ 45 Cat 5e Data outlet with shutter	P4045	500	P4045_DG	586
RJ 45 Cat6 Data outlet with shutter	P4046	558	P4046_DG	672
TV socket	P4500	140	P4500_DG	166
Blank off unit (1M)	P0001	40	P0001_DG	46
Foot Lamp with LED <b>NEW</b>	P7001	580	P7001_DG	680
Cord Outlet <b>NEW</b>	P4550	150	P4550_DG	176
LED Phase Indicator <b>NEW</b>	P5001	240	-	-
<b>Hotel Series <b>NEW</b></b>				
DND Switch	P6002	170	P6002_DG	198
MMR Switch	P6004	170	P6004_DG	198
DND & MMR Indicator	P6013	550	P6013_DG	644
Key Card Switch - Electronic	P6005	3150	P6005_DG	3690
<b>Cover Plates</b>				
1-2 M Grid & 1 M Cover Frame	P0701	98	P0701_DG	112
1-2 M Grid & 2 M Cover Frame	P0702	98	P0702_DG	116
3 M Grid & 3 M Cover Frame	P0703	124	P0703_DG	144
4 M Grid & 4 M Cover Frame	P0704	144	P0704_DG	168
6 M Grid & 6 M Cover Frame	P0706	182	P0706_DG	222
8 M Grid & 8 M Cover Frame - Horizontal	P0708	240	P0708_DG	290
8 M Grid & 8 M Cover Frame - Square	P0709	278	P0709_DG	326
12 M Grid & 12 M Cover Frame	P0712	336	P0712_DG	396
18 M Grid & 18 M Cover Frame	P0718	484	P0718_DG	570

# Opale - Switches with Satin Finish



- **Patented Smooth Satin Finish** - Scratch Resistant, Easy to Clean & Prevents light reflection off surface
- **Safe to Use** - High grade flame retardant polycarbonate material & Child Proof sockets with unique shutter design
- **Hassle Free Operation** - 'Soft sound' switches with Gold plated Data Socket contacts for better connection
- **Easy to Install** - Snap-In / Snap-Out front loading modules and terminals with indented screws
- **Green & Eco Friendly** - RoHS compliant range



X1001WH



X1286WH



X1186WH



X1005WH



X1085WH



X2005WH



X2106WH



X2010WH



X3200WH



X3104WH



X4010WH



X7003WH



X5001



X5002

Description	Reference for White	Unit MRP [₹]	Reference for Coke Grey	Unit MRP [₹]
<b>Switches</b>				
6A 1 way switch	X1001WH	134	AAKY1001	166
6A 1 way switch with Indicator lamp	X1081WH	198	AAKY1081	236
6A 2 way switch	X1002WH	174	AAKY1002	212
16A 1 way switch	X1101WH	202	AAKY1101	250
16A 1 way switch with Indicator lamp	X1181WH	280	AAKY1181	330
16A 2 way switch	X1102WH	270	AAKY1102	320
6A 1 way switch (2M)	X1021WH	222	AAKY1021	264
16A 1 way switch (2M)	X1121WH	284	AAKY1121	340
6A 1 way switch with Indicator (2M)	X1028WH	268	AAKY1028	322
16A 1 way switch with Indicator (2M)	X1128WH	328	AAKY1128	390
20A DP switch with Indicator (2M)	X1286WH	474	AAKY1286	552
32A DP switch (2M)	AAKX1232	690	-	-
<b>Motor Starter Switch</b>				
25A Motor Starter switch	X1186WH	1205	AAKY1186	1450
<b>Bell Push</b>				
6A Bell Push	X1005WH	198	AAKY1005	238
6A Bell Push (2M)	X1025WH	278	AAKY1025	336
6A Bell Push with Indicator	X1085WH	262	AAKY1085	314
6A Bell Push with Indicator (2M)	X1086WH	298	AAKY1086	356
<b>Sockets</b>				
6A 2/3 Pin Socket Outlet with Shutter	X2005WH	214	AAKY2005	254
6A "Uni Socket" Outlet with Shutter	X2007WH	266	AAKY2007	304
6A/16A 3-Pin Socket Outlet with Shutter	X2106WH	328	AAKY2106	384
13A Multi Pin Socket Outlet with Shutter	X2010WH	322	AAKY2010	386
16A 3-Pin Socket Outlet with Shutter	X2103WH	362	AAKY2103	436
13A BS flat Pin Socket Outlet with Shutter	X2403WH	454	AAKY2403	544
20A 3 Pin Socket Outlet with Shutter	X2206WH	406	AAKY2206	488
25A 3 Pin Socket Outlet with Shutter	X2207WH	440	AAKY2207	526
<b>Fan Regulators &amp; Dimmers</b>				
Step type fan regulator (2M)	X3200WH	758	AAKY3200	906
Dimmer 400W (1M)	X3104WH	680	AAKY3104	814
Dimmer 400W (2M)	X3004WH	1055	AAKY3004	1265
Dimmer 1200W	X3012WH	1360	AAKY3012	1630
<b>USB Chargers <span style="color: orange;">NEW</span></b>				
2 Gang USB Charger - 2.1A (2M)	X7003WH	2245	AAKY7003	2625
<b>Accessories</b>				
RJ11 Telephone outlet (no shutter)	X4010WH	174	AAKY4010	212
RJ11 Telephone outlet with shutter	X4011WH	176	AAKY4011	212
Twin RJ11 Telephone outlets (no shutter) (1M)	X4020WH	264	AAKY4020	322
RJ45 Data Outlet with shutter	X4045WH	620	AAKY4045	730
TV Socket	X4500WH	164	AAKY4500	202
RJ45 Cover for Key Stone Type	X4050WH	200	AAKY4050	242
Gripped Cord Outlet	X4550WH	180	AAKY4550	216
Buzzer	X3300WH	742	AAKY3300	820
Blank off unit (1M)	X0001WH	44	AAKY0001	60
Neon Phase Indicator (Red)	X5001	280	-	-
Neon Phase Indicator (Green)	X5002	280	-	-
Neon Phase Indicator (Yellow)	X5003	280	-	-

# Opale - Switches with Satin Finish



AAKX6002 + AAKX6004 + X0702



AAKX6006 + X0703

Description	Reference	Unit MRP [₹]
<b>Hotel Series*</b>		
DND Panel	AAKX6001	436
DND Switch	AAKX6002	340
MMR Panel	AAKX6003	412
MMR Switch	AAKX6004	340
Key Tag Switch (Mechanical Type 20 A)	AAKX6005	888
Shaver Socket	AAKX6006	3745

\*Available in white colour only



X0733WH



AAKX0744



AAKX0754

Description	Reference for White	Unit MRP [₹]	Reference for Coke Grey	Unit MRP [₹]	Reference for Matt Silver	Unit MRP [₹]	Reference for Matt Gold	Unit MRP [₹]
<b>Cover Plates</b>								
1-2 M Grid & 1 M Cover Frame	X0701	114	AAKY0801	138	AAKX0741	276	AAKX0751	276
1-2 M Grid & 2 M Cover Frame	X0702	120	AAKY0802	144	AAKX0742	298	AAKX0752	298
3 M Grid & 3 M Cover Frame	X0703	142	AAKY0803	172	AAKX0743	356	AAKX0753	356
3 M Universal Grid & 3 M Cover Frame	X0733WH	188	AAKY0833	224	AAKX0744	356	AAKX0754	356
4 M Grid & 4 M Cover Frame	X0704	166	AAKY0804	204	AAKX0745	424	AAKX0755	424
6 M Grid & 6 M Cover Frame	X0706	232	AAKY0806	276	AAKX0746	524	AAKX0756	524
8 M Grid & 8 M Cover Frame - Horizontal	X0708	302	AAKY0808	360	AAKX0747	686	AAKX0757	686
8 M Grid & 8 M Cover Frame - Square	X0709	358	AAKY0809	428	AAKX0748	686	AAKX0758	686
12 M Grid & 12 M Cover Frame	X0712	420	AAKY0812	502	AAKX0749	936	AAKX0759	936
18 M Grid & 18 M Cover Frame	AAKX0718	548	-	-	-	-	-	-

# Opale - Exclusive Range of Colour Plates NEW



Rustic Bronze

Mulberry Red

Lavender Passion

Description	Reference for Rustic Bronze	Reference for Mulberry Red	Reference for Lavender Passion	Unit MRP [₹]
1-2M Grid & 1M Cover Frame	X0701_RB	X0701_MR	X0701_LP	276
1-2M Grid & 2M Cover Frame	X0702_RB	X0702_MR	X0702_LP	298
3M Grid & 3M Cover Frame	X0703_RB	X0703_MR	X0703_LP	356
3M Uni Grid & 3M Cover Frame	X0733_RB	X0733_MR	X0733_LP	356
4M Grid & 4M Cover Frame	X0704_RB	X0704_MR	X0704_LP	424
6M Grid & 6M Cover Frame	X0706_RB	X0706_MR	X0706_LP	524
8M Grid & 8M Cover Frame - Linear	X0708_RB	X0708_MR	X0708_LP	686
8M Grid & 8M Cover Frame - Square	X0709_RB	X0709_MR	X0709_LP	686
12M Grid & 12M Cover Frame	X0712_RB	X0712_MR	X0712_LP	936



Champagne Gold

Solid Black

Green Oak

Gleaming Grey

Misty Grey

Black Graphite

Description	Reference for Champagne Gold	Reference for Solid Black	Reference for Green Oak	Reference for Gleaming Grey	Reference for Misty Grey	Reference for Black Graphite	Unit MRP [₹]
1-2M Grid & 1M Cover Frame	X0701_CHG	X0701_SB	X0701_GO	X0701_GG	X0701_MG	X0701_BG	276
1-2M Grid & 2M Cover Frame	X0702_CHG	X0702_SB	X0702_GO	X0702_GG	X0702_MG	X0702_BG	298
3M Grid & 3M Cover Frame	X0703_CHG	X0703_SB	X0703_GO	X0703_GG	X0703_MG	X0703_BG	356
3M Uni Grid & 3M Cover Frame	X0733_CHG	X0733_SB	X0733_GO	X0733_GG	X0733_MG	X0733_BG	356
4M Grid & 4M Cover Frame	X0704_CHG	X0704_SB	X0704_GO	X0704_GG	X0704_MG	X0704_BG	424
6M Grid & 6M Cover Frame	X0706_CHG	X0706_SB	X0706_GO	X0706_GG	X0706_MG	X0706_BG	524
8M Grid & 8M Cover Frame - Linear	X0708_CHG	X0708_SB	X0708_GO	X0708_GG	X0708_MG	X0708_BG	686
8M Grid & 8M Cover Frame - Square	X0709_CHG	X0709_SB	X0709_GO	X0709_GG	X0709_MG	X0709_BG	686
12M Grid & 12M Cover Frame	X0712_CHG	X0712_SB	X0712_GO	X0712_GG	X0712_MG	X0712_BG	936

## You Choose a colour, we get it done!



Choose the cover plate colour of your choice from the 100+ options available in the shade card\*

\*Contact Schneider Electric Sales Representative for details

Please contact Customer Care Center for Stockable and Non stockable status of references.

NORMAL STOCK ITEMS

W.E.F. March 12, 2018

# ZENcelo India - The Revolutionary Full-Flat Switch



- **World's First and only Full-Flat Mechanical Switch**
- **Patented Iso-Motion Technology** - Ensures switch stays in the same position whether On or Off
- **Robust & Strong** - Made of corrosion-resistant, heat-resistant and impact-resistant polycarbonate
- **Safe to Use** - Electric arc encapsulated switches and Data Sockets with patented integrated shutter
- **Designed to Last** - Switches tested to 80,000 times; Sockets tested to 15,000 cycles.
- **Green & Eco Friendly** - RoHS compliant range



IN8401



IN8401/16



IN8411



IN8486/20



IN8405

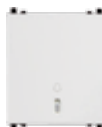

IN8425



IN84SFR



IN8404D



IN8426U



IN8426/16



IN8431RJS4



IN8432USB\_WE



INH8451



INH8454

Description	Reference for White	Unit MRP [₹]	Reference for Dark Grey	Unit MRP [₹]
<b>Switches</b>				
6A 1 Way switch	IN8401	290	IN8401(BZ)	364
6A 1 Way switch (2M)	IN8421	442	IN8421(BZ)	532
6A 2 Way switch	IN8402	348	IN8402(BZ)	416
6A 1 Way switch with Neon	IN8481	432	IN8481(BZ)	518
16AX~20A 1 Way switch	IN8401/16	418	IN8401/16(BZ)	510
16AX~20A 1 Way switch (2M)	IN8421/16	588	IN8421/16(BZ)	696
16AX~20A 1 Way switch with Neon	IN8481/16	590	IN8481/16(BZ)	700
16AX~20A 1 Way switch with Neon (2M)	IN8482/16	696	IN8482/16(BZ)	818
16AX~20A 2 Way switch	IN8402/16	584	IN8402/16(BZ)	690
16AX~20A 2 Way switch (2M)	IN8422/16	700	IN8422/16(BZ)	822
16AX~20A 1 Way 2G switch (1M)	IN8444/16	678	IN8444/16(BZ)	818
10AX Intermediate switch	IN8430/IM	976	IN8430/IM(BZ)	1110
20A DP Switch with Neon (2M)	IN8486/20	910	IN8486/20(BZ)	1075
32A DP Switch with Neon (2M)	IN8486/32	1430	IN8486/32(BZ)	1700
<b>Motor Starter Switch</b>				
25A Motor Starter switch (2M)	IN8425MS	2320	IN8425MS(BZ)	2465
<b>Bell Push</b>				
6A Bell Push switch	IN8405	394	IN8405(BZ)	476
6A Bell Push switch (2M)	IN8425	576	IN8425(BZ)	680
6A Bell Push switch with Neon	IN8485	512	IN8485(BZ)	604
6A Bell Push switch with Neon (2M)	IN8486	636	IN8486(BZ)	750
<b>Sockets</b>				
2~3 Pin Universal Socket with Shutter	IN8426U	452	IN8426U(BZ)	548
6A/16A 3 Pin Socket with Shutter	IN8426/16	676	IN8426/16(BZ)	828
13A Flat Pin Socket with Shutter	IN84213	926	IN84213(BZ)	1095
International Socket with Shutter	IN84213IS	798	IN84213IS(BZ)	998
Universal 2 Pin Socket with Shutter	IN84226U	476	IN84226U(BZ)	558
20A 3 Pin Socket with Shutter	IN84220	862	IN84220(BZ)	1014
25A 3 Pin Socket with Shutter	IN84225	922	IN84225(BZ)	1105
<b>Fan Regulators &amp; Dimmers</b>				
Fan Control (5 Speeds)	IN84SFR	1605	IN84SFR(BZ)	1925
Full Flat 400W Dimmer Module (1 Gang)	IN8404D	1375	IN8404D(BZ)	1630
<b>USB Chargers <span style="background-color: orange; color: white; padding: 2px;">NEW</span></b>				
1 Gang USB Charger - 2.1A (1M)	IN8431USB_WE	2725	IN8431USB_BZ	3125
2 Gang USB Charger - 2.1A (2M)	IN8432USB_WE	3985	IN8432USB_BZ	4585
<b>Accessories</b>				
RJ11 Telephone Outlet with shutter (1 Gang)	IN8431RJS4	448	IN8431RJS4(BZ)	548
RJ45 Cat6 Data Outlet with shutter	IN8431RJ6	1555	IN8431RJ6(BZ)	1910
Data Outlet Wall Plate (for RJ45 key stone jack)	IN8431RJC	428	IN8431RJC(BZ)	504
TV Socket	IN8431TV	328	IN8431TV(BZ)	396
Cord Outlet	IN8445CO	376	IN8445CO(BZ)	456
Foot Lamp with White LED (2M)	IN8490FLW	3035	-	-
Foot Lamp with Yellow LED (2M)	IN8490FLY	2960	-	-
Blank off unit (1M)	IN8430X	100	IN8430X(BZ)	124
<b>Hotel Series</b>				
Do Not Disturb Panel	INH8451	2100	INH8451(BZ)	2485
Make My Room Panel	INH8454	1905	INH8454(BZ)	2250
Do Not Disturb Switch	INH8452	1040	INH8452(BZ)	1225
Do Not Disturb Switch (2M)	INH8453	1060	INH8453(BZ)	1250
Make My Room Switch	INH8455	1018	INH8455(BZ)	1200



# ZENcelo India - The Revolutionary Full-Flat Switch



IN8403C

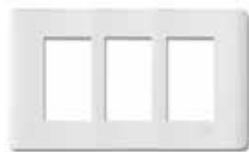

IN8406C



IN8402C(BZ)

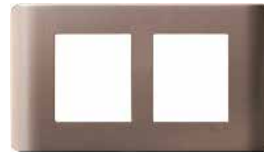

IN8404C(SZ)

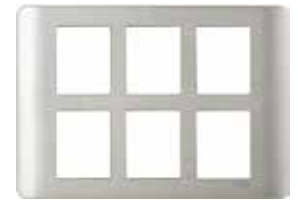

IN84012C(SA)

Description	Reference for White	Unit MRP [₹]	Reference for Dark Grey	Unit MRP [₹]	Reference for Silver Bronze	Unit MRP [₹]	Reference for Satin Silver	Unit MRP [₹]
<b>Cover Plates</b>								
1M Grid & 1M Cover Frame	IN8401C	248	IN8401C(BZ)	294	IN8401C(SZ)	684	IN8401C(SA)	684
2M Grid & 2M Cover Frame	IN8402C	258	IN8402C(BZ)	308	IN8402C(SZ)	676	IN8402C(SA)	676
3M Grid & 3M Cover Frame	IN8403C	304	IN8403C(BZ)	362	IN8403C(SZ)	832	IN8403C(SA)	832
4M Grid & 4M Cover Frame	IN8404C	330	IN8404C(BZ)	426	IN8404C(SZ)	1000	IN8404C(SA)	1000
6M Grid & 6M Cover Frame	IN8406C	504	IN8406C(BZ)	600	IN8406C(SZ)	1370	IN8406C(SA)	1370
8M Grid & 8M Cover Frame - Horizontal	IN8408HC	600	IN8408HC(BZ)	718	IN8408HC(SZ)	1855	IN8408HC(SA)	1855
8M Grid & 8M Cover Frame - Square	IN8408SC	816	IN8408SC(BZ)	1025	IN8408SC(SZ)	2320	IN8408SC(SA)	2320
9M Grid & 9M Cover Frame	IN8409C	986	IN8409C(BZ)	1230	IN8409C(SZ)	2975	IN8409C(SA)	2975
12M Grid & 12M Cover Frame	IN84012C	1305	IN84012C(BZ)	1605	IN84012C(SZ)	4150	IN84012C(SA)	4150
18M Grid & 18M Cover Frame	IN84018C	1840	IN84018C(BZ)	2165	IN84018C(SZ)	5495	IN84018C(SA)	5495

# ZENcelo BS - The Revolutionary Full-Flat Switch



- **British Standard** - Consistent Plate Size across functions
- World's First and only **Full-Flat Mechanical Switch**
- **Patented Iso-Motion Technology** - Ensures switch stays in the same position whether On or Off
- **Robust & Strong** - Made of corrosion-resistant, heat-resistant and impact-resistant polycarbonate
- **Designed to Last** - Switches tested to 80,000 times; Sockets tested to 15,000 cycles.
- **Green & Eco Friendly** - RoHS compliant range



E8432/1>SZ-OS



E8433/1-OS



E8415\_10\_WE



E8431D20-OS



E431RJS4-OS

Description	Reference for White	Unit MRP [₹]	Reference For Silver Brozne	Unit MRP [₹]
<b>Switches</b>				
16AX/20A 1 Gang 1 Way switch with Ondicator	E8431/1-OS	344	E8431/1>SZ-OS	428
16AX/20A 2 Gang 1 Way switch with Ondicator	E8432/1-OS	532	E8432/1>SZ-OS	666
16AX/20A 3 Gang 1 Way switch with Ondicator	E8433/1-OS	872	E8433/1>SZ-OS	1090
16AX/20A 4 Gang 1 Way switch with Ondicator	E8434/1-OS	1255	E8434/1>SZ-OS	1570
16AX/20A 1 Gang 2 Way switch	E8431/2-OS	368	E8431/2>SZ-OS	458
16AX/20A 2 Gang 2 Way switch	E8432/2-OS	646	E8432/2>SZ-OS	806
16AX/20A 3 Gang 2 Way switch	E8433/2-OS	938	E8433/2>SZ-OS	1180
16AX 1 Gang Intermediate Switch	E8431/I-OS	1020	E8431/I>SZ-OS	1280
<b>Double Pole Switches</b>				
20A 1 Gang Double Pole switch with Neon	E8431D20-OS	978	E8431D20>SZ-OS	1280
32A 1 Gang Double Pole switch with Neon	E8431D32-OS	1300	E8431D32>SZ-OS	1705
<b>Bell Push</b>				
10A Full-Flat Bell Switch	E8431BP1-OS	374	E8431BP1>SZ-OS	462
<b>Sockets</b>				
5A 1 Gang 3 Round Pin Switched Socket with Shutter and Ondicator	E8415/5-OS	680	E8415/5>SZ-OS	846
5A 1 Gang 3 Round Pin Switched Socket with Neon and Shutter	E8415/5N-OS	956	E8415/5N>SZ-OS	1200
15A 1 Gang 3 Round Pin Switched Socket with Shutter and Ondicator	E8415/15-OS	802	E8415/15>SZ-OS	1004
15A 1 Gang 3 Round Pin Switched Socket with Shutter and Neon	E8415/15N-OS	1180	E8415/15N>SZ-OS	1460
16A 1 Gang International Socket with Shutter	E84426/16IS-OS	854	E84426/16IS>SZ-OS	1062
13A 1 Gang Switched Socket with Ondicator	E8415-OS	1004	E8415>SZ-OS	1255
13A 1 Gang Switched Socket with Neon	E8415N-OS	846	E8415N>SZ-OS	1056
10/16A Switched Socket Outlet - Shuttered	E8415_16_10_WE	894	E8415_16_10_SZ	1046
10A 2-3 pin Switched Socket Outlet - Shuttered	E8415_10_WE	712	E8415_10_SZ	886
<b>Fan Regulators &amp; Dimmers</b>				
350VA 50Hz 1 Gang Full-Flat Universal Dimmer with LED	E8431EPD4-OS	2220	E8431EPD4>SZ-OS	2775
<b>Accessories</b>				
1 Gang TV Socket Master	E8431TVM-OS	430	E8431TVM>SZ-OS	536
1 Gang Telephone Socket on Shuttered Wallplate	E8431RJS4-OS	548	E8431RJS4>SZ-OS	686
2 Gang Telephone Socket on Shuttered Wallplate	E8432RJS4-OS	1280	E8432RJS4>SZ-OS	1590
1 Gang Data Outlet Category 5E with Integrated Shutter	E8431RJ/5-OS	854	E8431RJ/5>SZ-OS	1062
1 Gang Data Outlet Category 6 with Integrated Shutter	E8431RJ/6-OS	1020	E8431RJ/6>SZ-OS	1280
1 Gang Data Outlet Category 5E on Shuttered Wallplate	E8431RJS/5-OS	1062	E8431RJS/5>SZ-OS	1335
1 Gang Data Outlet Category 6 on Shuttered Wallplate	E8431RJS/6-OS	1280	E8431RJS/6>SZ-OS	1595
2 Gang Data Outlet Category 5E with Integrated Shutter	E8432RJ/5-OS	1495	E8432RJ/5>SZ-OS	1860
2 Gang Data Outlet Category 6 with Integrated Shutter	E8432RJ/6-OS	1915	E8432RJ/6>SZ-OS	2385
2 Gang Data Outlet Category 5E on Shuttered Wallplate	E8432RJS/5-OS	1495	E8432RJS/5>SZ-OS	1860
2 Gang Data Outlet Category 6 on Shuttered Wallplate	E8432RJS/6-OS	1915	E8432RJS/6>SZ-OS	2385
2 Gang Telephone + Data Outlet Category 5E with Integrated Shutter	E8432TDRJ/5-OS	1280	E8432TDRJ/5>SZ-OS	1595
2 Gang Telephone + Data Outlet Category 5E on Shuttered Wallplate	E8432TDRJS/5-OS	1590	E8432TDRJS/5>SZ-OS	1985
2 Gang Telephone + Data Outlet Category 6 on Shuttered Wallplate	E8432TDRJS/6-OS	1805	E8432TDRJS/6>SZ-OS	2255
TV + Cat 6 shutter outlet	E8432TVRJ6_WE_G1	1590	E8432TVRJ6_SZ_G1	1735
1 Gang Wallplate without Modular Jack	E8431RJ-OS	220	E8431RJ>SZ-OS	270
1 Gang Shuttered Wallplate without Modular Jack	E8431RJS-OS	330	E8431RJS>SZ-OS	402
2 Gang Wallplate without Modular Jack	E8432RJ-OS	368	E8432RJ>SZ-OS	456
2 Gang Shuttered Wallplate without Modular Jack	E8432RJS-OS	388	E8432RJS>SZ-OS	480
25A Connection Unit	E8431TB-OS	854	E8431TB>SZ-OS	1062
Blank off unit (1M)	E8430X-OS	228	E8430X>SZ-OS	284

# ZENcelo BS - The Revolutionary Full-Flat Switch



E8431USB\_WE



E8431USB\_SZ



E8431USB\_SA

Description	Reference For White	Unit MRP [₹]	Reference For Silver Bronze	Unit MRP [₹]	Reference For Satin Silver	Unit MRP [₹]
-------------	---------------------	--------------	-----------------------------	--------------	----------------------------	--------------

## USB Chargers

1 Gang 2.1A USB Charger	E8431USB_WE	3545	E8431USB_SZ	3955	E8431USB_SA	3955
-------------------------	-------------	------	-------------	------	-------------	------



E8431EKT-OS



E8432DMS>SZ-OS



E84T727H-OS



E84T727V>SZ-OS

Description	Reference for White	Unit MRP [₹]	Reference For Silver Bronze	Unit MRP [₹]
-------------	---------------------	--------------	-----------------------------	--------------

## Hotel Series

Illuminated "Do Not Disturb" & "Please Clean Up" Symbols	E8432DM-OS	2820	E8432DM>SZ-OS	3525
Illuminated "Do not Disturb" Symbol	E8431D-OS	822	E8431D>SZ-OS	1022
1 Gang Full-Flat Switch with Illuminated "Do not Disturb" Symbol	E8431DS-OS	442	E8431DS>SZ-OS	552
2 Gang Full-Flat Switch with Illuminated "Do not Disturb" & "Please Clean Up" Symbols	E8432DMS-OS	3105	E8432DMS>SZ-OS	3880
1 Gang Full-Flat Bell Switch with Illuminated "Do Not Disturb" Symbol	E8431BPD-OS	2365	E8431BPD>SZ-OS	2870
1 Gang Full-Flat Bell Switch with Illuminated "Do Not Disturb" & "Please Clean Up" Symbols	E8431BPDM-OS	3015	E8431BPDM>SZ-OS	3765
Electronic Key Card Time Delay Switch	E8431EKT-OS	6030	E8431EKT>SZ-OS	7540
Universal Shaver Unit, Vertical	E84T727V-OS	3410	E84T727V>SZ-OS	4250
Universal Shaver Unit, Horizontal	E84T727H-OS	3410	E84T727H>SZ-OS	4250

# NEO - Face the Future



- **Unique** - Horizontal Switches available for Horizontal Decor
- **Stylish** - Ingenious combination of matt and gloss finish along with a fresh look through use of LED technology
- **Convenient** - Switches with soft, luminiscent “locators” to locate the switch in dark
- **Dual Tone Colours** - Standard colours include Grey and White incorporating Blue and White LED respectively



E3033H1EBGS



E3032H1EWWW



E3032H1FWWW



E3032V1EBGS



E3031V1EWWW



E3032V1FWWW

Description	Horizontal Dolly Reference	Unit MRP [₹]	Vertical Dolly Reference	Unit MRP [₹]
<b>Grey Switches with Blue LED Indicator</b>				
10AX 250V 1 Gang 1 Way Switch	E3031H1EBGS	660	E3031V1EBGS	660
10AX 250V 1 Gang 2 Way Switch	E3031H2EBGS	770	E3031V2EBGS	770
10AX 250V 2 Gang 1 Way Switch	E3032H1EBGS	1030	E3032V1EBGS	1030
10AX 250V 2 Gang 2 Way Switch	E3032H2EBGS	1215	E3032V2EBGS	1215
10AX 250V 3 Gang 1 Way Switch	E3033H1EBGS	1510	E3033V1EBGS	1510
10AX 250V 3 Gang 2 Way Switch	E3033H2EBGS	1780	E3033V2EBGS	1780
10AX 250V 4 Gang 1 Way Switch	E3034H1EBGS	1880	-	-
10AX 250V 4 Gang 2 Way Switch	E3034H2EBGS	2225	-	-
<b>White Switches with White LED Indicator</b>				
10AX 250V 1 Gang 1 Way Switch	E3031H1EWWW	640	E3031V1EWWW	640
10AX 250V 1 Gang 2 Way Switch	E3031H2EWWW	738	E3031V2EWWW	738
10AX 250V 2 Gang 1 Way Switch	E3032H1EWWW	1022	E3032V1EWWW	1022
10AX 250V 2 Gang 2 Way Switch	E3032H2EWWW	1180	E3032V2EWWW	1190
10AX 250V 3 Gang 1 Way Switch	E3033H1EWWW	1445	E3033V1EWWW	1445
10AX 250V 3 Gang 2 Way Switch	E3033H2EWWW	1675	E3033V2EWWW	1675
10AX 250V 4 Gang 1 Way Switch	E3034H1EWWW	1835	-	-
10AX 250V 4 Gang 2 Way Switch	E3034H2EWWW	2175	-	-
<b>White Switches with White Fluorescent Indicator</b>				
10AX 250V 1 Gang 1 Way Switch	E3031H1FWWW	636	E3031V1FWWW	636
10AX 250V 1 Gang 2 Way Switch	E3031H2FWWW	718	E3031V2FWWW	718
10AX 250V 2 Gang 1 Way Switch	E3032H1FWWW	1016	E3032V1FWWW	1016
10AX 250V 2 Gang 2 Way Switch	E3032H2FWWW	1185	E3032V2FWWW	1185
10AX 250V 3 Gang 1 Way Switch	E3033H1FWWW	1440	E3033V1FWWW	1440
10AX 250V 3 Gang 2 Way Switch	E3033H2FWWW	1700	E3033V2FWWW	1700
10AX 250V 4 Gang 1 Way Switch	E3034H1FWWW	1860	-	-
10AX 250V 4 Gang 2 Way Switch	E3034H2FWWW	2195	-	-

# NEO - Face the Future



E3031VBP>GS-OS



E3031VD20>EWWW-OS



E3426/10IS>GS-OS



EH3015/6>GS-OS



E3031TV>GS-OS



E3031RJ5E>WW-OS



E3031USB\_GS



E3031USB\_WW



E3032HDM>GS-OS



E3031EKTH>WW-OS

Description	Horizontal Dolly Reference	Unit MRP [₹]	Vertical Dolly Reference	Unit MRP [₹]
<b>Bell Push</b>				
4A 1 Way Horizontal Bell Push Switch	E3031HBP>GS-OS	1375	E3031HBP>WW-OS	1345
4A 1 Way Vertical Bell Push Switch	E3031VBP>GS-OS	1350	E3031VBP>WW-OS	1330
<b>DP Switches</b>				
1 Gang Horizontal 20A DP Switch with Blue LED for Grey Switch and White LED for White Switch	E3031HD20EBGS	1145	E3031HD20EWWW	1115
1 Gang Vertical 20A DP Switch with Blue LED for Grey Switch and White LED for White Switch	E3031VD20>EBGS-OS	1115	E3031VD20>EWWW-OS	1080
1 Gang 32A DP Rocker Switch with Blue LED for Grey Switch and White LED for White Switch	E3031DR32EBGS	1675	E3031DR32EWWW	1615
<b>Intermediate Switch</b>				
16AX Intermediate Switch with Blue LED for Grey Switch and White LED for White Switch	E3031VIA>EBGS-OS	1810	E3031VIA>EWWW-OS	1740
<b>Socket</b>				
15A 1 Gang Switch Socket Outlet Grey with Blue LED for Grey Socket and White LED for White Socket	E3015/15-EBGS-EX	1965	E3015/15-EWWW-EX	1910
10A International Socket	E3426/10IS>GS-OS	1535	E3426/10IS>WW-OS	1470
6A 1 Gang Switch Socket Outlet	EH3015/6>GS-OS	1135	EH3015/6>WW-OS	1090
6/16A 1 Gang Switch Socket Outlet	EH3015/16/6>GS-OS	1585	EH3015/16/6>WW-OS	1550
<b>Fan Regulators &amp; Dimmers</b>				
1 Gang Fan Control	E3031FRGS	1835	E3031FRWW	1665
1 Gang Dimmer with Blue LED for Grey Dimmer and White LED for White Dimmer	E3031HD>EBGS-OS	11020	E3031HD>EWWW-OS	10915
2 Gang Horizontal Dimmer with Blue LED for Grey Dimmer and White LED for White Dimmer	E3032HD>EBGS-OS	19330	E3032HD>EWWW-OS	18790
<b>Accessories</b>				
1 Gang TV Socket Outlet	E3031TV>GS-OS	1022	E3031TV>WW-OS	998
2 Gang TV Socket Outlet	E3032VTV>GS-OS	1995	E3032VTV>WW-OS	1024
4 Pin 1 Gang Telephone Outlet (CAT 3)	E3031RJ>GS-OS	1185	E3031RJ>WW-OS	1125
4 Pin 1 Gang 8 Pin Data Outlet (CAT 5E)	E3031RJ5E>GS-OS	3140	E3031RJ5E>WW-OS	3025
4 Pin 2 Gang Telephone Outlet (CAT 3)	E3032RJ>GS-OS	2120	E3032RJ>WW-OS	1995
4 Pin Telephone Outlet (CAT 3) + 8 Pin Data Outlet (CAT 5E)	E3032TD>GS-OS	3870	E3032TD>WW-OS	3745
1G Keystone Plate Shuttered	E3031RJK>GS-OS	680	E3031RJK>WW-OS	656
2G Keystone Plate Shuttered	E3032RJK>GS-OS	710	E3032RJK>WW-OS	698
1 x 2.1A USB Charger	E3031USB_GS	4800	E3031USB_WW	4590
25A Connection Unit	E3031TB>GS-OS	900	E3031TB>WW-OS	862
1 Gang Blank Plate	E3030X>GS-OS	580	E3030X>WW-OS	554
2 Gang Blank Plate	ET3030X>GS-OS	1295	ET3030X>WW-OS	1250
<b>Hotel Series</b>				
2 Gang "Do Not Disturb" & "Please Clean Up" Combined (Horizontal)	E3032HDM>GS-OS	5975	E3032HDM>WW-OS	5790
1 Gang "Do Not Disturb" & "Please Clean Up" Combined (Vertical)	E3030VDM>GS-OS	5565	E3030VDM>WW-OS	5260
1 Gang Bell Push with "Please Clean Up" Combined (Vertical)	E3031VBPM>GS-OS	4565	E3031VBPM>WW-OS	4400
1 Gang Bell Push with "Do not Disturb" Combined (Vertical)	E3031VBPD>GS-OS	4565	E3031VBPD>WW-OS	4400
1 Gang Bell Push with "Do Not Disturb" & "Please Clean Up" Combined (Vertical)	E3031VBPDM>GS-OS	4565	E3031VBPDM>WW-OS	4400
Electronic Key Card Switch (Horizontal)	E3031EKTH>GS-OS	12660	E3031EKTH>WW-OS	12325
115/240V Shaver Outlet (Vertical)	ET3727V>GS-OS	6570	ET3727V>WW-OS	6440

# ULTI Impress - The Ultimate Switch



- **Super Stylish** - Single piece face plate with maximized space for plate along with soft radiant blue/amber backlight for switches
- **Multiple Finish Options** - Crystal Glass, Champagne Gold, Brushed Silver, Pearl White
- **Technological Marvel** - Mechanical switch with touch and feel of electronic switch with patented impress mechanism
- **Strength & Durability** - Ionized metal grid for back housing plate
- **Automation Alignment** - Lighting Control & Automation available in same finish



1 Gang Switch with Crystal Glass Plate



2 Gang Switch with Pearl White Plate



4 Gang Switch with Brushed Silver Plate



Bell Push with Champagne Gold Plate



6-16A Switched Socket with Crystal Glass Plate

Description	Colour	Reference	Unit MRP [₹]
<b>Switches</b>			
1 Gang 250V 16AX 1 Way Switch module with Blue LED	Module	U201SPM/1>B00-OS	4395
1 Gang 250V 16AX 2 Way Switch module with Blue LED	Module	U201SPM/2>B00-OS	4760
Cover Plate for 1 Gang Switch	Brushed Silver	UC21SW/P>XBS-OS	1320
	Champagne Gold	UC21SW/P>XCG-OS	1320
	Crystal Glass	UC21SW/P>XGL-OS	5675
	Pearl White	UC21SW/P>XPW-OS	1320
2 Gang 250V 16AX 1 Way Switch module with Blue LED	Module	U202SPM/1>B00-OS	5865
2 Gang 250V 16AX 2 Way Switch module with Blue LED	Module	U202SPM/2>B00-OS	6585
Cover Plate for 2 Gang Switch	Brushed Silver	UC22SW/P>XBS-OS	1880
	Champagne Gold	UC22SW/P>XCG-OS	1880
	Crystal Glass	UC22SW/P>XGL-OS	6495
	Pearl White	UC22SW/P>XPW-OS	1880
4 Gang 250V 16AX, 1 Way Switch module with Blue LED	Module	U204SPM/1>B00-OS	9970
4 Gang 250V 16AX 2 Way Switch module with Blue LED	Module	U204SPM/2>B00-OS	11235
Cover Plate for 4 Gang Switch	Brushed Silver	UC24SW/P>XBS-OS	2990
	Champagne Gold	UC24SW/P>XCG-OS	2990
	Crystal Glass	UC24SW/P>XGL-OS	7875
	Pearl White	UC24SW/P>XPW-OS	2990
<b>Double Pole Switch</b>			
1 Gang 250V 20A Double Pole Switch module with Blue LED	Module	U201SPM/DP>B00-OS	5865
Cover Plate for 1 Gang DP Switch	Brushed Silver	UC21DP/P>XBS-OS	1830
	Champagne Gold	UC21DP/P>XCG-OS	1830
	Crystal Glass	UC21DP/P>XGL-OS	5500
	Pearl White	UC21DP/P>XPW-OS	1830
<b>Bell Push</b>			
Bell Push Switch Module with Blue LED	Module	US31BPB00	2245
Cover Plate for Bell Press Switch	Brushed Silver	UC31BPXBBS	1790
	Champagne Gold	UC31BPXCG	1790
	Crystal Glass	UC31BPXGL	5865
	Pearl White	UC31BPXPW	1790
<b>Sockets</b>			
6-16A Switched Socket	Module	US15/616000	5210
Cover Plate for 6-16A Switched Socket	Brushed Silver	UC15/616XBS	2805
	Champagne Gold	UC15/616XCG	2805
	Crystal Glass	UC15/616XGL	7325
	Pearl White	UC15/616XPW	2805
6A 2/3 Pin Switched Socket	Module	US15/6U000	4405
Cover Plate for 6A 2/3 Pin Switched Socket	Brushed Silver	UC15/6UXBS	2400
	Champagne Gold	UC15/6UXCG	2400
	Crystal Glass	UC15/6UXGL	6220
	Pearl White	UC15/6UXPW	2400
International Socket	Module	US426/16IS000	2665
Cover Plate for International Socket	Brushed Silver	UC426/16ISXBS	1875
	Champagne Gold	UC426/16ISXCG	1875
	Crystal Glass	UC426/16ISXGL	5310
	Pearl White	UC426/16ISXPW	1875

# ULTI Impress - The Ultimate Switch



Data Socket with Brushed Silver Cover Plate



Twin Data Socket with Crystal Glass Cover Plate



Keycard switch with Brushed Silver Cover Plate



Shaver Socket with Champagne Gold Cover Plate

Description	Colour	Reference	Unit MRP [₹]	
<b>Accessories</b>				
TV Socket Module	Module	US31TV000	2245	
	Brushed Silver	UC31TVXBS	2150	
	Champagne Gold	UC31TVXCG	2150	
Cover Plate for TV Socket	Crystal Glass	UC31TVXGL	7135	
	Pearl White	UC31TVXPW	2150	
	Data Socket Module	Module	UD31RJ000	2805
		Brushed Silver	UDC31RJXBS	2150
Champagne Gold		UDC31RJXCG	2150	
Crystal Glass		UDC31RJXGL	7130	
Cover Plate for Data Socket	Pearl White	UDC31RJXPW	2150	
	Twin Data Socket Module	Module	UD32TD000	4290
		Brushed Silver	UDC32DXBS	2150
		Champagne Gold	UDC32DXCG	2150
Crystal Glass		UDC32DXGL	7230	
Cover Plate for Twin Data Socket	Pearl White	UDC32DXPW	2150	
	Blank Module	Module	US31X000	2570
		Brushed Silver	UC31XXBS	2340
		Champagne Gold	UC31XXCG	2340
Crystal Glass		UC31XXGL	4770	
Cover Plate for Blank Module	Pearl White	UC31XXPW	2340	
	<b>USB Chargers</b>			
	1 Gang 2.1A USB Charger Module	White	US31USB_WE	3455
		Grey	US31USB_GY	3455
Brushed Silver		UC31USB_XBS	2305	
Cover Plate for 1 Gang 2.1A USB Charger	Champagne Gold	UC31USB_XCG	2305	
	Crystal Glass	UC31USB_XGL	6885	
	Pearl White	UC31USB_XPW	2305	
	<b>Hotel Series</b>			
Keycard Switch with Cover Plate	Brushed Silver	U31EKTHBBS	10155	
	Champagne Gold	U31EKTHACG	10155	
	Crystal Glass	U31EKTHBGL	13375	
	Pearl White	U31EKTHBPW	10155	
Shaver Socket with Cover Plate	Brushed Silver	US727HXBS	8575	
	Champagne Gold	US727HXCG	8575	
	Crystal Glass	US727HXGL	12495	
	Pearl White	US727HXPW	8575	

# Kavacha - Weather Protected Series



WHT20-GY-EX



CSW110-GY-EX



A3031WBP\_WE

- Pleasing looks with **IP56 protection**
- Large press switch
- Co-moulded sealing with no risk of gasket damage
- Chemical resistant & UV stabilised

Description	Reference	Unit MRP [₹]
<b>Kavacha IP56 Surface Mount Switches</b>		
<b>Switches with Looping Terminal</b>		
10A 1 Gang 2 Way Switch	CSW110-GY-EX	1830
20A/16A 1 Gang 2 Way Switch	CSW120-GY-EX	2100
10 A 2 Gang 2 Way Switch	CSW110/2-GY-EX	2490
20A/16A 1 Gang 2 Way Switch	CSW120/2-GY-EX	2790
10A 1 Gang 2 Way Bell Press Return Switch	CSW110BPR-GY-EX	2120
<b>Switches with Looping Terminal with Neon</b>		
10 A 1 Gang 2 Way surface switch with Looping Terminal with Neon	CSW110N-GY-EX	2100
10A 2 Gang 2 Way with Looping Terminal and Neon	CSW110/2N-GY-EX	2645
20A 1 Gang 2 Way with Looping Terminal with Neon	CSW120N-GY-EX	2255
20A/16A 2 Gang 2 Way with Looping Terminal with Neon	CSW120/2N-GY-EX	2950
<b>Double Pole Switches</b>		
20A 1 Gang Double Pole Switch	CSW220-GY-EX	2875
20A 2 Gang Double Pole Switch	CSW220/2-GY-EX	3025
<b>Kavacha Heavy Duty Isolator Switches</b>		
20A Double Pole	WHB220-RG	3170
20A Triple Pole	WHT20-GY-EX	3530
35A Triple Pole	WHT35-GY-EX	3940
55A Triple Pole	WHT55-GY-EX	4195
63A Triple Pole	WHT63-GY-EX	4490
<b>Kavacha IP56 Surface Mount Combined Switched Socket Outlets</b>		
<b>Combination Switch Socket Outlets</b>		
16A Single Pole Switched Socket Outlet	CSC316RP-GY-EX	3025
16A Single Pole Switched Socket Outlet with Neon	CSC316RPN-GY-EX	3260
<b>Kavacha IP56 Surface Mount Socket Outlets</b>		
16A Socket Outlet	CSO316RP-GY-EX	1790
<b>Kavacha Full-Time Weatherproof Cover</b>		
Full-Time Weatherproof Membrane Switch Cover (Transparent) IP55	E223M_TR	1045
Full-Time Weatherproof Membrane Switch Cover (White)IP56	E223M_WE	944
Full-Time Weatherproof Single Gang Socket Cover (Transparent) IP55	E223R_TR	736
Full-Time Weatherproof Single Gang Socket Cover (White)IP56	E223R_WE	666
<b>Kavacha Weatherproof Door Bell Switch</b>		
Surface Mounted Door Bell with LED Indicator (Grey)IP44	A3031WBP_GY	1115
Surface Mounted Door Bell with LED Indicator (White)IP44	A3031WBP_WE	974



# Metal Boxes



- **Weld free design** to minimize corrosion and rusting without compromising on strength
- Mounting clip and earth pin designed for **easier installation** and to **avoid loss during transportation**
- Removable side plates and optimized knock outs and for **easier wiring**
- Completely tested & validated as per **IS 14772**

Description	Reference	Unit MRP [₹]
<b>Metal Boxes for Indian Format Ranges (Livia, Opale &amp; ZENcelo India) <span style="background-color: orange; color: white; padding: 2px;">NEW</span></b>		
<b>0.8 mm thickness</b>		
Metal Box 1 & 2 modules	ME0102	84
Metal Box 3 modules	ME0103	108
Metal Box 4 modules	ME0104	124
<b>1 mm thickness</b>		
Metal Box 1 & 2 modules	MR1102	94
Metal Box 3 modules	MR1103	122
Metal Box 4 modules	MR1104	142
Metal Box 6 modules	MR1106	194
Metal Box 8 modules - Horizontal	MR1108	256
Metal Box 8 modules - Square	MR1109	256
Metal Box 12 module	MR1112	322
Metal Box 18 modules	MR1118	382

Description	Reference	Unit MRP [₹]
<b>Metal Boxes for BS Format Ranges (ZENcelo BS, NEO, ULTI)</b>		
<b>1 mm thickness</b>		
2 GANG GI Metal Boxes	GM1102	230
3 GANG GI Metal Boxes	GM1103	322
4 GANG GI Metal Boxes	GM1104	424

- Special Metal Box with Gang Partition to accommodate BS format ranges
- Single Metal Box can accommodate up to 4 units
- Number of Gangs for Metal Box = Number of units that it can accommodate  
(Eg. 3 GANG Metal Box can accommodate up to 3 BS format Units)

# EzInstall 3 - ULTI ZIGBEE

- 2 wire design, True Retrofit
- Intelligent dimmer with Auto Load Detection feature
- Capability to dim or switch on/off different load types (in case of non dimmable loads connected to dimmer)
- Very high network scalability with Peer to Peer Mesh technology
- Each unit (switch, dimmer) is a repeater – no need for any additional repeater
- Moods created at a touch of a button
- ZigBee protocol is based on the IEEE802.15.4 standard and works on 2.4GHz radio frequency



Crystal Glass



Brushed Silver



Champagne Gold



Pearl White

Description	Catalogue No.	Unit MRP [₹]
1 Gang 2000VA Zigbee Switch	U201SRY2KWZB	18155
1 Gang Switch Coverplate - Brushed Silver	UC21SWXBS	1439
1 Gang Switch Coverplate - Pearl White	UC21SWXPW	1439
1 Gang Switch Coverplate - Champagne Gold	UC21SWXCG	1439
1 Gang Switch Coverplate - Crystal Glass	UC21SWXGL	6668
2 Gang 2X1000VA Zigbee Switch	U202SRY2KWZB	20931
2 Gang Switch Coverplate - Brushed Silver	UC22SWXBS	2002
2 Gang Switch Coverplate - Pearl White	UC22SWXPW	2002
2 Gang Switch Coverplate - Champagne Gold	UC22SWXCG	2002
2 Gang Switch Coverplate - Crystal Glass	UC22SWXGL	7037
1 Gang 550W Zigbee Dimming Switch	U201DST600ZB	18746
1 Gang Dimmer Coverplate - Brushed Silver	UC21DMXBS	2304
1 Gang Dimmer Coverplate - Pearl White	UC21DMXPW	2304
1 Gang Dimmer Coverplate - Champagne Gold	UC21DMXCG	2304
1 Gang Dimmer Coverplate - Crystal Glass	UC21DMXGL	6960
2 Gang 2X300W Zigbee Dimming Switch	U202DST600ZB	22514
2 Gang Dimmer Coverplate - Brushed Silver	UC22DMXBS	2304
2 Gang Dimmer Coverplate - Pearl White	UC22DMXPW	2304
2 Gang Dimmer Coverplate - Champagne Gold	UC22DMXCG	2304
2 Gang Dimmer Coverplate - Crystal Glass	UC22DMXGL	8738
1 Gang 300VA Zigbee Curtain Control Switch	U201SCN300ZB	22705
1 Gang Curtain Coverplate - Brushed Silver	UC21CNXBS	2070
1 Gang Curtain Coverplate - Pearl White	UC21CNXPW	2070
1 Gang Curtain Coverplate - Champagne Gold	UC21CNXCG	2070

Description	Reference	Unit MRP [₹]
1 Gang 16A Zigbee Double Pole	U301SDP16AZB	22552
1 Gang DP Cover Plate – Crystal Glass	UC21DPXGL	7155
1 Gang DP Cover Plate – Pearl White	UC21DPXPW	2360
1 Gang DP Cover Plate – Brushed Silver	UC21DPXBS	2360
1 Gang DP Cover Plate – Champagne Gold	UC21DPXCG	2360

Description	Catalogue No.	Unit MRP [₹]
1 Gang Curtain Coverplate - Crystal Glass	UC21CNXGL	6221
2 Gang 2X300VA Zigbee Curtain Control Switch	U202SCN600ZB	26016
2 Gang Curtain Coverplate - Brushed Silver	UC22CNXBS	2304
2 Gang Curtain Coverplate - Pearl White	UC22CNXPW	2304
2 Gang Curtain Coverplate - Champagne Gold	UC22CNXCG	2304
2 Gang Curtain Coverplate - Crystal Glass	UC22CNXGL	8738
500W ZigBee IND PlugAdaptor Dimmer Wh	U104ND500ZB_WE	17919
Zigbee Handheld Remote Controller	U105RHH001ZB	12088
2Key Zigbee Freelocate Switch, Brushed Silver	U102RWMZB_XBS	9817
2Key Zigbee Freelocate Switch, Champagne Gold	U102RWMZB_XCG	9817
2Key Zigbee Freelocate Switch, Crystal Glass	U102RWMZB_XGL	13997
2Key Zigbee Freelocate Switch, Pearl White	U102RWMZB_XPW	9817
6Key Zigbee Freelocate Switch, Brushed Silver	U106RWMZB_XBS	11013
6Key Zigbee Freelocate Switch, Champagne Gold	U106RWMZB_XCG	11013
6Key Zigbee Freelocate Switch, Crystal Glass	U106RWMZB_XGL	15882
6Key Zigbee Freelocate Switch, Pearl White	U106RWMZB_XPW	11013
Zigbee to RS232 Interface	UB3Z5	13058
Zigbee IR Gateway	U301RSDMZB	19503
Zigbee IP Gateway	U301IPGWZB	19252
Zigbee Analog Module	U30010V	10751



Once there were smart homes,  
now there are Wiser Homes.



For Details and price information please contact our nearest Sales Office

Sympholux enables you to optimally balance light and energy because Schneider Electric remains the only Lighting Control expert who offers you harmonious orchestration via three platforms

## KNX

## C-Bus

## DALI

No matter what your building type, location, budget or unique application and needs, no one is more perfectly placed to provide you with an optimized solution than Schneider Electric



### The standard in interoperability



#### KNX Benefits

- Developed and supported by one organization of manufacturers and users
- Open protocol compatibility with a vast choice of products/ applications
- Full 3rd party integration
- Total multi-functionality of products and media
- Single-system-specific configuration software
- Extensive worldwide trainingradio frequency

## C-Bus

### The expert in ambience lighting



#### C-BUS Benefits

- Fully topology independent
- Industry standard CAT5e cable
- Highly reliable and robust, cost effective per-node control
- Simple commissioning and installation
- Easy-to-reconfigure distributed intelligent local programming
- High-power and architectural dimming
- Consistent switch and C-Bus product look and feel



### Optimizing individual control and centralized management



#### DALI Benefits

- Single-system control of lighting and emergency lights from multiple manufacturers
- Delivers full dimming of ballasts, groups and lines
- Comprehensive monitoring and energy saving at each device level
- Simple wiring, configuration, maintenance and reconfiguration
- Ethernet backbone linking multiple DALI networks into a single system

## ULTI ELV



- ULTI style, state-of-art lighting control and electrical automation scheme for hotel guest room control, offering sophisticated design
- Light touch buttons equipped with LED backlight enable guest to locate switch in a dark environment
- Comparative with Universal Input/ Output module (Room Logic Gateway -RLG) or third party guestroom control system

Description	MOQ	Reference	Unit MRP [₹]
DND/PCU Control Switch	1	US32DMRJ000	On Request
Cover Plate for DND/PCU Switch	50	UC32HDMSXCG	On Request
Cover Plate for DND/PCU Switch	1	UC32HDMSXBS	On Request
Cover Plate for DND/PCU Switch	50	UC32HDMSXGL	On Request
Cover Plate for DND/PCU Switch	1	UC32HDMSXPW	On Request
DND/PCU Indicator w/Bell Press (Blue)	1	US33DMRJB00	On Request
DND/PCU Indicator w/Bell Press (Amber)	1	US33DMRJA00	On Request
Cover Plate for DND/PCU with bell push switch	1	UC33HBPDMXCG	On Request
Cover Plate for DND/PCU with bell push switch	1	UC33HBPDMXBS	On Request
Cover Plate for DND/PCU with bell push switch	1	UC33HBPDMXGL	On Request
Cover Plate for DND/PCU with bell push switch	50	UC33HBPDMXPW	On Request
Cardkey Switch (Low Voltage)	15	U31EKTHLVBWP	On Request
Cardkey Switch (Low Voltage)	15	U31EKTHLVACG	On Request
Cardkey Switch (Low Voltage)	15	U31EKTHLVBGL	On Request
Cardkey Switch (Low Voltage)	15	U31EKTHLVBBS	On Request
1 Gang ELV Switch (Amber)	30	U201SPM_RJ_A00	On Request
1 Gang ELV Switch (Blue)	1	U201SPM_RJ_B00	On Request
Coverplate for 1 Gang ELV switch	1	UC21SWXCG	On Request
Coverplate for 1 Gang ELV switch	1	UC21SWXBS	On Request

Description	MOQ	Reference	Unit MRP [₹]
Coverplate for 1 Gang ELV switch	1	UC21SWXGL	On Request
Coverplate for 1 Gang ELV switch	1	UC21SWXPW	On Request
2 Gang ELV Switch- AMBER	30	U202SPM_RJ_A00	On Request
2 Gang ELV Switch- BLUE	1	U202SPM_RJ_B00	On Request
Coverplate for 2 Gang ELV switch	1	UC22SWXCG	On Request
Coverplate for 2 Gang ELV switch	1	UC22SWXBS	On Request
Coverplate for 2 Gang ELV switch	1	UC22SWXGL	On Request
Coverplate for 2 Gang ELV switch	1	UC22SWXPW	On Request
4 Gang ELV Switch- AMBER	30	U204SPM_RJ_A00	On Request
4 Gang ELV Switch- BLUE	1	U204SPM_RJ_B00	On Request
Coverplate for 4 Gang ELV switch	50	UC24SW_XCG	On Request
Coverplate for 4 Gang ELV switch	50	UC24SW_XBS	On Request
Coverplate for 4 Gang ELV switch	50	UC24SW_XGL	On Request
Coverplate for 4 Gang ELV switch	50	UC24SW_XPW	On Request

### Colours Available (suffix as in coverplates above)

BS	Brushed Silver
PW	Pearl White
CG	Champagne Gold
GL	Crystal Glass

## Neo ELV



Description	MOQ	Reference	Unit MRP [₹]
1 gang ELV switch with Amber LED	1	E3031LV>EAGS-OS	On Request
2 gang ELV switch with Amber LED	1	E3032LV>EAGS-OS	On Request
3 gang ELV switch with Amber LED	1	E3033LVEAGS	On Request
1 Gang Curtain Switch without LED	1	E3031CLV>GS-OS	On Request
2 Gang Curtain Switch without LED	1	E3032CLV>EAGS-OS	On Request
1 gang Dimmer Module with Amber LED	1	E3031DLV_EAGS	On Request
2 gang Dimmer Module with Amber LED	1	E3032DLV_EAGS	On Request
Bell Push with DND and MMR Indicator	1	E3031DMLV>EAGS-OS	On Request
Bell Push with DND, MMR and Butler Indicator	60	E3031DMLV>EAGS-OS	On Request
DND/MMR Control switch	1	E3032DMLV>EAGS-OS	On Request
DND, MMR and Butler Control switch	1	E3033DMLV>EAGS-OS	On Request
Key card switch with Amber LED	60	E3031EKTHLVEAGS	On Request

## Zencelo ELV



Description	MOQ	Reference	Unit MRP [₹]
1 Gang Sw W/ LED Indicator	1	E8431LV	On Request
1 Gang Sw W/ LED Indicator, SZ	1	E8431LVSZ	On Request
2 Gang Sw W/ LED Indicator	1	E8432LV	On Request
2 Gang Sw W/ LED Indicator, SZ	1	E8432LV_SZ	On Request
3 Gang Sw W/ LED Indicator	1	E8433LV	On Request
3 Gang Sw W/ LED Indicator, SZ	1	E8433LVSZ	On Request
2 Gang Curtain Sw Open/Close	1	E8432CLV	On Request
2 Gang Curtain Sw Open/Close, SZ	1	E8432CLV SZ	On Request
Elv Keycard Switch	50	E8431EKTLV	On Request
Elv Keycard Switch, SZ	50	E8431EKTLV SZ	On Request
1 Gang Sw W/ DND	1	E8431DSL	On Request
1 Gang Sw W/ DND, SZ	1	E8431DSL SZ	On Request
2 Gang Sw W/ DND & PCU	1	E8432DMSLV	On Request
2 Gang Sw W/ DND & PCU, SZ	1	E8432DMSLV SZ	On Request
Bell Press W/ DND & PCU Indicator	1	E8431BDMLV	On Request
Bell Press W/ DND & PCU Indicator, SZ	1	E8431BDMLV SZ	On Request
3 Gang Curtain Sw Open/Half/Close	1	E8433CLV	On Request
3 Gang Curtain Sw Open/Half/Close, SZ	1	E8433CLV_SZ	On Request

### Colours Available (suffix as above)

SZ	Silver Bronze
No suffix after LV	White Colour

## Hotel Room Controller

Description	MOQ	Reference	Unit MRP
Hotel Room Controller 42IO	1	HRCPDG42R	On Request
Hotel Room Controller 28IO	1	HRCBPBG28R	On Request
Hotel Room Controller 14 I/O Expansion Module	1	HRCEP14R	On Request

### Note:

- All Hotel Series items are non stockable and lead time is around 10-14 weeks.
- Customised bedside panels will have a MOQ. Pls speak with the product manager in your region for details.
- For Bedside panel, pl take additional items like MCU card and power supply.
- For room logic gateway, power supply is required separately.

## Occupancy Sensors



Description	Reference	Unit MRP [₹]
Argus 300 Electronic outdoor movement detector, max. range 16 m with IP55 protection	MTN564319	12026
Argus 360 Electronic movement detector for outdoor ceiling mounting max. range 16 m, IP55 protection	MTN564419	13293
Argus 110 Electronic outdoor movement detector; angle of detection 110 degrees, max. range 12 mtrs, IP55 protection	MTN565119	5820
Argus 220 Electronic movement detector for outdoor ceiling mounting angle of detection 220 degrees, max. range 12 mtrs, IP55 protection	MTN565219	8730
ARGUS Presence Master with IR, DALI	MTN5510-1519	15147
<b>Accessories</b>		
Mounting bracket for Argus 110 and Argus 220 Sensors	MTN565291	734
Extension for Argus 300 Sensor	MTN554399	1226

## Ceiling and Wall Mount Sensors

### PIR and Ultrasonic Sensors /Surface Mount Sensors



Description	Reference	Unit MRP [₹]
Surface Mount Single-Load 360 degrees PIR	CSS54E_WE	2814
Flush/Surface Mount Single-Load 360 degrees PIR	SAE-UE-MS-CSAWE	3443
Flush Mount Dual load 360 degrees standalone sensor	SAE-UE-MS-CDBWE	6674
ARGUS Presence Dual-Tech PIR & Ultrasonic Sensor - 1ch	CCT551011	14127
ARGUS Presence High Frequency High Bay Sensor - 2ch	CCT551023	14127
Flush/Surface Mount Dual Load 360° PIR, 0-10V Analog Dimmable Sensor with remote	SAE-UE-MS-CDDWE	8078
Remote for PIR and Ultrasonic Motion sensor	SAE-UE-MS-IR10T	1676
Remote for standalone PIR sensor	SAE-UE-MS-1R-WE	2111

### Wall Mount Sensors



Description	Reference	Unit MRP [₹]
Neo C-Metro 200 degrees wall mount sensor, grey colour	E3751MS3C_GS	3874
Neo C-Metro 90 degrees wall mount sensor, grey colour	E3751MS3A_GS	3874
Zencelo 110 degrees wall mount sensor, white colour	E84751MS3B_WE	3580
Zencelo 90 degrees wall mount sensor, white colour	E84751MS3A_WE	3580

# Control and Command Control Systems Products

## Time Switches



- 7D, 24H Programmable switch .Voltage Rating: 230V AC +10%, -15%
- Consumption: 1 channel - max. 4VA; 2 channels - max. 7VA
- Memory: Upto 56 Switching Operations
- Back up of program & time by lithium battery: Operating reserve: 6 Years
- Overall dimensions: 5 modules
- Cable length: 100m
- Minimum time between two switching operations: 1 min

Description	Module Width 18mm/module	Reference	Unit MRP [₹]
IHP - intuitive switch - 1 channel - 7D 24 H	2.5	CCT15720	8721
IHP Plus - intuitive switch - 1 channel - 7D 24 H, pulse programming	2.5	CCT15721	10080
IHP - intuitive switch - 2 channels - 7D 24 H	2.5	CCT15722	10539
IHP+ - intuitive switch - 2 channels - 7D 24 H, pulse programming	2.5	CCT15723	12237

## Timers



- Switching capacity 16 A, max
- Delay range from 30 sec to 20 min
- Capacity for lighted pushbutton 150 mA
- Electric distribution busbar compatibility
- Output power capacity CCT15232-2300W
- Output power capacity CCT15223-3600W

Description	Module Width 18mm/module	Reference	Unit MRP [₹]
MINs - electronic timer - 0.5 to 20 min	1	CCT15232	4553
MINs - electronic timer - 0.5 to 20 min with switch Off Warning	1	CCT15233	7367
MINs - electronic timer - 0.5 to 20 min with switch Off Warning and Impulse relay function	1	CCT15234	7417

## Light sensitive switch



- Includes wall mounted cell
- Adjustable brightness threshold 2 to 2000 Lux
- 2 LEDs to signal the sensor status and the output status
- Test button: To check the product and load cabling
- Switching capacity: 16Amp
- Screwless Terminals compatible with rigid and flexible wires
- Consumption 6 VA
- Size 45mm

Description	Module Width 18mm/module	Reference	Unit MRP [₹]
IC 2000 - light sensitive switch - 2...2000 lux - with wall-mounted cell	2.5	CCT15368	10489
Wall-mounted cell for IC2000 light sensitive switch		CCT15268	3145
IC 200 - light sensitive switch - 2...200 lux - with wall-mounted cell	2.5	CCT15284	7367
Switchboard cell for IC200 light sensitive switch		15281	2543
IC Astro (Astronomical Time Switches)	2.5	CCT15223	16249



## Time Switches (Analog)



Description	Module Width 18mm/module	Reference	Unit MRP [₹]
IH 24H 16 A 15 mts interval 1 channel	1	15336	3801
IH 24H 16 A 30 mts interval 1 channel	1	CCT15365	4269
IH 24H + 7 day 10 A 1 channel- Max 16 On, 16 Off and 7 On + 7 Off cycles	3	15366	6380
IH 7 day 16 A 1 channel- Max 21 On and 21 Off cycles	3	CCT15367	6233
ITM4C6E - multifunctional switch - 4 channels (7 days + dated days)	5	15270	13109
IH 24H 16 A 30 mts 1 channel without reserve	3	CCT16364	3452



Description	Reference	Unit LP [₹]
<b>Actassi Copper Cables</b>		
Cat 6a 10G UTP Cable 305m Blue CM	ACTTG4P6AUCM3RBU	On Request
Cat 6a 10G UTP Cable 305m White LSZH	ACTTG4P6AULS3RBU	On Request
Cat 6a 10G FTP Cable 305m BlueCM	ACTTG4P6ASCM3RBU	On Request
Cat 6a 10G FTP Cable 305m BlueLSZH	ACTTG4P6ASLS3RBU	On Request
Cat.6 4pr UTP Cable 305m Blue CM	ACT4P6UCM3RBBU_E	On Request
Cat.6 4pr UTP Cable 305m white LSZH	ACT4P6ULS3RBWE_E	On Request
Cat.6 4pr FTP Cable 305m Blue CM	ACT4P6SCM3RBBU	On Request
Cat.5e 4pr UTP Cable 305m Grey CM	ACT4P5EUCM3RBGY	On Request
<b>Copper Connectivity</b>		
CAT 6A UTP Keystone White Non Shutter	VDIB1775XUWE_E	384
FTP/UTP 24-port Patch Panel Unloaded	ACTPPS24NSU	2744
Cat.6A 10G FTP 24-port Patch Panel Loaded	ACTPP6ATGS24NSS	17074
Cat.6A 10G UTP 24-port Patch Panel Non-Shutter Loaded	ACTPP6ATGU24NSS_E	12030
Cat 6A UTP PP 24 Port 1UAngled UnLoaded	ACTPP6ATGUXNSA_E	2786
Cat 6A FTP Patchcord 1 mtr Grey	ACTPTG6ASBCM10GY_E	500
Cat 6A FTP Patchcord 1 mtr Blue	ACTPTG6ASBCM10BU_E	500
Cat 6AFTP Patchcord 1 mtr Red	ACTPTG6ASBCM10RD_E	500
Cat 6A FTP Patchcord 2 mtr Grey	ACTPTG6ASBCM20GY_E	599
Cat 6A FTP Patchcord 2 mtr Blue	ACTPTG6ASBCM20BU_E	599
Cat 6AFTP Patchcord 2 mtr Red	ACTPTG6ASBCM20RD_E	599
Cat 6A FTP Patchcord 3 mtr Grey	ACTPTG6ASBCM30GY_E	726
Cat 6A FTP Patchcord 3 mtr Blue	ACTPTG6ASBCM30BU_E	726
Cat 6AFTP Patchcord 3 mtr Red	ACTPTG6ASBCM30RD_E	725
SOCKET RJ45 CAT6 KSTONE BLUE UTP	VDIB1776UBU_E	244
SOCKET RJ45 CAT6 KSTONE RED UTP	VDIB1776URD_E	244
SOCKET RJ45 CAT6 KSTONE YELLOW UTP	VDIB1776UYL_E	244
SOCKET RJ45 CAT6 KSTONE GREEN UTP	VDIB1776UGR_E	244
SOCKET RJ45 CAT6 KSTONE WHITE UTP	VDIB1776UWE_E	244
Cat 6 24 AWG UTP stranded Patch cord 1 Meter - Grey	ACTPC6UBCM10GY_E	217
Cat 6 24 AWG UTP stranded Patch cord 1 Meter - Yellow	ACTPC6UBCM10YL_E	217
Cat 6 24 AWG UTP stranded Patch cord 1 Meter - Green	ACTPC6UBCM10GR_E	217
Cat 6 24 AWG UTP stranded Patch cord 1 Meter - Blue	ACTPC6UBCM10BU_E	217
Cat 6 24 AWG UTP stranded Patch cord 1 Meter - Red	ACTPC6UBCM10RD_E	217
Cat 6 24 AWG UTP stranded Patch cord 2 Meter - Grey	ACTPC6UBCM20GY_E	237
Cat 6 24 AWG UTP stranded Patch cord 2 Meter - Yellow	ACTPC6UBCM20YL_E	237
Cat 6 24 AWG UTP stranded Patch cord 2 Meter - Green	ACTPC6UBCM20GR_E	237
Cat 6 24 AWG UTP stranded Patch cord 2 Meter - Blue	ACTPC6UBCM20BU_E	237
Cat 6 24 AWG UTP stranded Patch cord 2 Meter - Red	ACTPC6UBCM20RD_E	237
Cat 6 24 AWG UTP stranded Patch cord 3 Meter - Grey	ACTPC6UBCM30GY_E	268
Cat 6 24 AWG UTP stranded Patch cord 3 Meter - Yellow	ACTPC6UBCM30YL_E	268
Cat 6 24 AWG UTP stranded Patch cord 3 Meter - Green	ACTPC6UBCM30GR_E	268
Cat 6 24 AWG UTP stranded Patch cord 3 Meter - Blue	ACTPC6UBCM30BU_E	268
Cat 6 24 AWG UTP stranded Patch cord 3 Meter - Red	ACTPC6UBCM30RD_E	268
Cat 6 24 AWG UTP stranded Patch cord 1 Meter LSZH - Grey	ACTPC6UBLS10GY_E	227
Cat 6 24 AWG UTP stranded Patch cord 1 Meter- Yellow LSZH	ACTPC6UBLS10YL_E	227
Cat 6 ,24 AWG UTP stranded Patch cord 1 Meter-Green LSZH	ACTPC6UBLS10GR_E	227
Cat 6 24 AWG UTP stranded Patch cord 1 Meter Blue	ACTPC6UBLS10BU_E	227
Cat 6 24 AWG UTP stranded Patch cord 1 Meter Red	ACTPC6UBLS10RD_E	227
Cat 6 24 AWG UTP stranded Patch cord 2 Meter LSZH Grey	ACTPC6UBLS20GY_E	247

Description	Reference	Unit LP [₹]
<b>Actassi Copper Connectivity</b>		
Cat 6 24 AWG UTP stranded Patch cord 2 Meter Yellow	ACTPC6UBLS20YL_E	247
Cat 6 24 AWG UTP stranded Patch cord 2 Meter Green	ACTPC6UBLS20GR_E	247
Cat 6 24 AWG UTP stranded Patch cord 2 Meter Blue	ACTPC6UBLS20BU_E	247
Cat 6 24 AWG UTP stranded Patch cord 2 Meter Red	ACTPC6UBLS20RD_E	247
Cat 6 24 AWG UTP stranded Patch cord 3 Meter LSZH Grey	ACTPC6UBLS30GY_E	279
Cat 6 24 AWG UTP stranded Patch cord 3 Meter Yellow	ACTPC6UBLS30YL_E	279
Cat 6A 24 AWG UTP stranded Patch cord 3 Meter Green	ACTPC6UBLS30GR_E	279
Cat 6 24 AWG UTP stranded Patch cord 3 Meter Blue	ACTPC6UBLS30BU_E	279
Cat 6 24 AWG UTP stranded Patch cord 3 Meter Red	ACTPC6UBLS30RD_E	279
Cat.5e UTP Keyst Non-Shutter Modular Jack White	ACTRJSM5ENSUWE	170
Cat5e UTP 24-port Non-Shutter Patch Panel Loaded	ACTPP5EU24NSS	4641
Cat.5e Patch Cord UTP 1M CM Grey	ACTPC5EUBCM10GY	200
Cat.5e Patch Cord UTP 2M CM Grey	ACTPC5EUBCM20GY	263
Cat.5e Patch Cord UTP 2M CM Red	ACTPC5EUBCM20RD	263





Life Is On

**Schneider**  
Electric

## Schneider Electric India Pvt. Ltd.

Corporate Office: 9th Floor, DLF Building No. 10, Tower C, DLF Cyber City, Phase II, Gurugram 122002 Haryana  
Tel.: ++91 124 3940400 Fax: ++91 124 4222036/ 037

**Ahmedabad**  
Schneider Electric India (P) Ltd.  
1506-1507, 15th Floor Shapth-5,  
SG Highway, Ahmedabad - 380015  
Tel.: 079-66826701

**Cochin**  
Schneider Electric India (P) Ltd.  
41 / 406- D1,3rd Floor, Beejay  
Towers,  
Rajaji Road Cochin- 682035  
Tel.: 0484-3048401

**Ludhiana**  
Schneider Electric India (P) Ltd.  
Office No. - 3, 5th Floor, Novelty Plaza  
Bhaiwala Chowk  
Ludhiana- 140001  
Tel.: 0161- 4656672-75

**Secunderabad**  
D.No. 1-8-271, # 401, Ashoka Bhoopal  
Chambers, SP Road,  
Secunderabad - 500003  
Tel.: 04039404000  
Fax.: 040-39131313

**Bengaluru**  
Schneider Electric India (P) Ltd.  
No. 3/1, JP Techno Park,  
Mezzanine Floor, Millers Tank Bund  
Road, Vasanth Nagar,  
Bengaluru - 560052. Tel.: 080-71481351

**Coimbatore**  
Schneider Electric India (P) Ltd.  
No. -104, Classic Tower, 3rd Floor,  
Trichy Road, Coimbatore- 641018  
Tel.: 0422-3940400

**Mumbai**  
Schneider Electric India (P)( Ltd)  
Marwah House, 2nd Floor  
Krishanlal Marwah Marg,  
Andheri (East), Mumbai - 400072  
Tel.: 91-22-30263300

**Vadodara**  
605 & 606, 6th Floor Ocean Building,  
Opp.Vadodara Central, Sarabhai Road,  
Vadodara-390005  
Tel.: 0265-3940400

**Bhubaneswar:**  
Schneider Electric India (P) Ltd.  
6th Floor, Block A, JSS Software Technol-  
ogy park , E 1/1 , Chandaka Industrial  
Estate, Info City , Bhubaneswar -751025  
Tel.: 0674-6672000

**Jaipur**  
Schneider Electric India (P) Ltd.  
Jaipur Business Centre 309, 3rd  
Floor, Sangam Tower 190, Church  
Road, Jaipur-302001  
Tel.: 0141-3912903

**Nagpur**  
Schneider Electric India (P) Ltd.  
Fortune Business Centre, 6,  
Basant Vihar, W.H.C Road  
Shankar Nagar, Nagpur- 440010  
Tel.: 0712-2558581

**Vishakhapatnam**  
Schneider Electric India (P) Ltd.  
Ratnam's Business Centre,  
D.N.10-1-43, 1st Floor  
Siripuram Fort,C.B.M.Compound,  
Visakhapatnam- 530016  
Tel.: 0891 - 2508990

**Chandigarh**  
Schneider Electric India (P) Ltd.  
2nd Floor of Tower A  
Bestech Business Tower  
Sector-66  
Mohali- 160059  
Tel.: 0172-3324500

**Kolkata**  
Schneider Electric (I)Pvt.Ltd,  
BP-4, Sector-V  
Technopolis  
3rd floor, Salt Lake City  
Kolkata- 700 091  
Tel.: 033-333640100-101

**Nashik:**  
Schneider Electric India (P) Ltd.  
401, 4th Floor Rishi Raj Towers, Jehan  
Circle, Gangapur Road,  
Nashik- 422013  
Tel: +91-7620498557

**Chennai**  
Schneider Electric India (P) Ltd.  
No:29, 2nd floor, Bannari Amman Towers,  
B-Block,RK Salai, Mylapore  
Chennai - 600 004  
Tel.:044- 39404000

**Lucknow**  
Schneider Electric India (P) Ltd.  
1st Floor, Asha Bhawan 27 / II -A,  
Gokhale Marg, Lucknow- 226001  
Tel.: 0522-4006010

**Pune**  
Schneider Electric India (P) Ltd.  
1st Floor, R.B. Business Centre  
Above Dass Electronics  
Sanghvi Nagar, Aundh, Pune- 411007  
Tel.: 020-39404000

### Customer Care Centre

Monday-Saturday, 9 a.m. to 8 p.m.

Toll-free numbers: 1800 419 4272, 1800 103 0011

Email: [customercare.in@schneider-electric.com](mailto:customercare.in@schneider-electric.com)

For more information, visit our website at: [www.schneider-electric.co.in](http://www.schneider-electric.co.in)

- All Prices are in Indian Rupees.
- Prices are subject to change without notice.
- Prices charged will be as prevailing on the date of dispatch.
- Maximum Retail Price (MRP) is inclusive of all taxes

- Tax incidence on invoices is basis applicable GST rates. Invoice amount not to exceed MRP.
- Invoice Amount = (MRP – less Applicable discount) + Applicable GST %

**Distributor**