



**Distributor :**

**Energy Power Save CO.,LTD**

Address : 442/2 Chan Road, Thung Watdon Sathon Bangkok Thailand 10120

Tel : +66 (02 ) 114 7145 - 9 Auto 5Line [www.7-mars.com](http://www.7-mars.com) Mobile Phone : +66 (089) 006 0906 Email : [info@7-mars.com](mailto:info@7-mars.com)

---

# Contents

About us.....	- 2 -
Cartridge Heater.....	- 4 -
Tubular Heater.....	- 12 -
Immersion Thread/Flange Heater.....	- 17 -
Diesel Parking Heater.....	- 25 -
Flexible Silicone Heater.....	- 32 -
Flexible Kapton Polyimide Heater.....	- 38 -
Band Heater.....	- 44 -



**Distributor :**

**Energy Power Save CO.,LTD**

Address : 442/2 Chan Road, Thung Watdon Sathon Bangkok Thailand 10120

Tel : +66 (02 ) 114 7145 - 9 Auto 5Line [www.7-mars.com](http://www.7-mars.com) Mobile Phone : +66 (089) 006 0906 Email : [info@7-mars.com](mailto:info@7-mars.com)

---

technical supports.

Our customers will enjoy from us the following benefits: A)professional service; B)high quality products; C)short sample and production lead time; D) placing OEM or ODM orders We believe in partnership, and are fully committed to control the supply chain in order to provide our customers high quality products, at competitive price, and in a timely manner. We look forward to building up long-term business relationship with you to our mutual benefit.



**Distributor :**

**Energy Power Save CO.,LTD**

Address : 442/2 Chan Road, Thung Watdon Sathon Bangkok Thailand 10120

Tel : +66 (02 ) 114 7145 - 9 Auto 5Line [www.7-mars.com](http://www.7-mars.com) Mobile Phone : +66 (089) 006 0906 Email : [info@7-mars.com](mailto:info@7-mars.com)

---

## Cartridge Heater



- Cartridge heater is a type of heating element for various machinery application, which is made of MgO powder or MgO tube, ceramic cap, resistance wire (NiCr2080), high temperature leads, seamless stainless steel sheath (304, 321, 316, 800, 840).
- Usually in tube form, that is used in heating applications by way of insertion into metal blocks via a series of drilled holes.



**Distributor :**

**Energy Power Save CO.,LTD**

Address : 442/2 Chan Road, Thung Watdon Sathon Bangkok Thailand 10120

Tel : +66 (02 ) 114 7145 - 9 Auto 5Line [www.7-mars.com](http://www.7-mars.com) Mobile Phone : +66 (089) 006 0906 Email : [info@7-mars.com](mailto:info@7-mars.com)

- Cartridge heaters are manufactured in two basic forms - High powerdensity ( $\leq 450^{\circ}\text{C}$ ) and Low and medium power density ( $\leq 300^{\circ}\text{C}$ ).
- High power density (heating surface power  $10\sim 25\text{w}/\text{cm}^2$ ), are widely used to heat Plastic injection moulds, Moulds, Platens, etc.
- Low and medium power density (heating surface power  $5\sim 11\text{w}/\text{cm}^2$ ), are more suitable for packing machinery, heat sealing, labelling machines and hot stamping applications.
- The high-quality stainless steel sheath provides long-lasting protection, even in the harshest industrial environments. Its max power density can reach up to  $40\text{w}/\text{cm}^2$ , and its maximum operating temperature can over  $800^{\circ}\text{C}$

### Technical parameters

<b>Resistance heating wire</b>	NiCr 80/20 wire
<b>Sheath Material</b>	Seamless SS304/316/321/ Incoloy800/840 alloy, etc.
<b>Voltages available</b>	12V/24V/36V/110V/220V/240V/380V/418V
<b>Wattage Tolerance</b>	$\pm 3\%$
<b>Resistance tolerance</b>	$\pm 3\%$
<b>Length tolerance</b>	$\pm 2\%$ or 3.2mm (1/8")
<b>Diameter</b>	From 2.0mm to 30mm
<b>Diameter tolerance</b>	+0.05mm ~0.1mm (+.002" -.004")
<b>Max operating temp</b>	$870^{\circ}\text{C}$ (1600F)
<b>Standard Cold Zone</b>	5~10mm
<b>Insulation resistance (cold)</b>	$\geq 500\ \text{M}\Omega$
<b>Maximum leakage current (cold)</b>	$\leq 0.5\ \text{mA}$
<b>Thermocouple Location</b>	Disc End, Sheath, Center of Heater
<b>Thermocouple</b>	Type J / K

### Application:

- Injection moulding - Internal heating of nozzles



**Distributor :**

**Energy Power Save CO.,LTD**

Address : 442/2 Chan Road, Thung Watdon Sathon Bangkok Thailand 10120

Tel : +66 (02 ) 114 7145 - 9 Auto 5Line [www.7-mars.com](http://www.7-mars.com) Mobile Phone : +66 (089) 006 0906 Email : [info@7-mars.com](mailto:info@7-mars.com)

- Hot runner systems - Heating of manifolds
- Packaging industry - Heating of cutting bars, Heating of hot stamps, etc.
- Medical/Laboratories: Dialysis, Sterilization, Blood Analyzer, Nebulizer, Blood/Fluid Warmer, etc.
- Food Service: Steamers, Dish Washers, etc.
- Industrial: Packaging Equipment, Hole Punches, Hot Stamp, etc.
- Extrusion/Rubber molds/Melt-blown Mould Industrial
- Hot press molding machiner
- Seal Machinery

.....

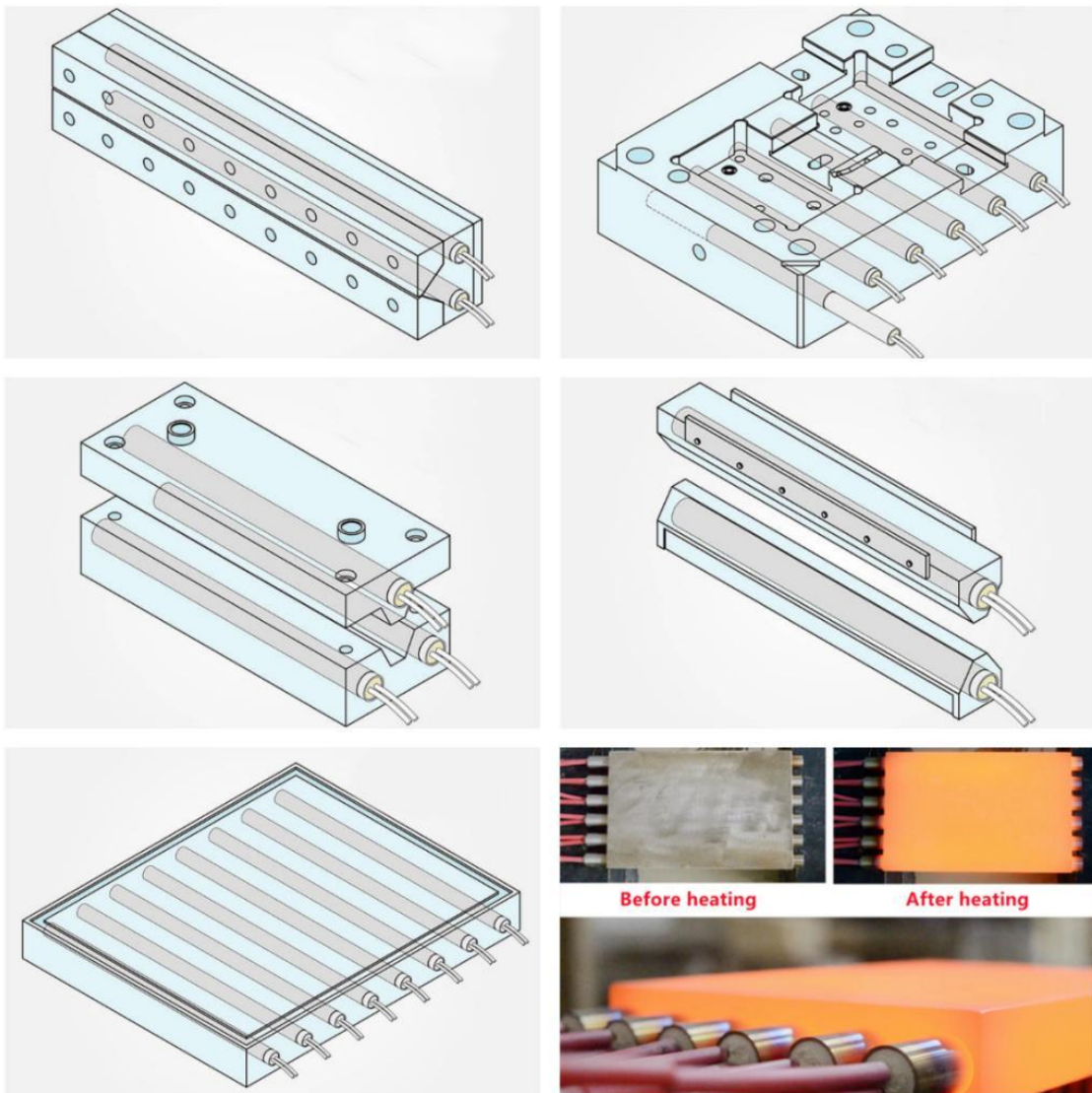



**Distributor :**

**Energy Power Save CO.,LTD**

Address : 442/2 Chan Road, Thung Watdon Sathon Bangkok Thailand 10120

Tel : +66 (02 ) 114 7145 - 9 Auto 5Line [www.7-mars.com](http://www.7-mars.com) Mobile Phone : +66 (089) 006 0906 Email : [info@7-mars.com](mailto:info@7-mars.com)

## 1. Ordinary Cartridge Heater





**Distributor :**

**Energy Power Save CO.,LTD**

Address : 442/2 Chan Road, Thung Watdon Sathon Bangkok Thailand 10120

Tel : +66 (02 ) 114 7145 - 9 Auto 5Line [www.7-mars.com](http://www.7-mars.com) Mobile Phone : +66 (089) 006 0906 Email : [info@7-mars.com](mailto:info@7-mars.com)

## 2. L-shaped Right Angle Cartridge Heater





**Distributor :**

**Energy Power Save CO.,LTD**

Address : 442/2 Chan Road, Thung Watdon Sathon Bangkok Thailand 10120

Tel : +66 (02 ) 114 7145 - 9 Auto 5Line [www.7-mars.com](http://www.7-mars.com) Mobile Phone : +66 (089) 006 0906 Email : [info@7-mars.com](mailto:info@7-mars.com)

### 3. Threaded Cartridge Heater







**Distributor :**

**Energy Power Save CO.,LTD**

Address : 442/2 Chan Road, Thung Watdon Sathon Bangkok Thailand 10120

Tel : +66 (02 ) 114 7145 - 9 Auto 5Line [www.7-mars.com](http://www.7-mars.com) Mobile Phone : +66 (089) 006 0906 Email : [info@7-mars.com](mailto:info@7-mars.com)

---

## 4. Finned Cartridge Heater





**Distributor :**

**Energy Power Save CO.,LTD**

Address : 442/2 Chan Road, Thung Watdon Sathon Bangkok Thailand 10120

Tel : +66 (02 ) 114 7145 - 9 Auto 5Line [www.7-mars.com](http://www.7-mars.com) Mobile Phone : +66 (089) 006 0906 Email : [info@7-mars.com](mailto:info@7-mars.com)

## 5. Cartridge Heater with Built-in Thermocouple

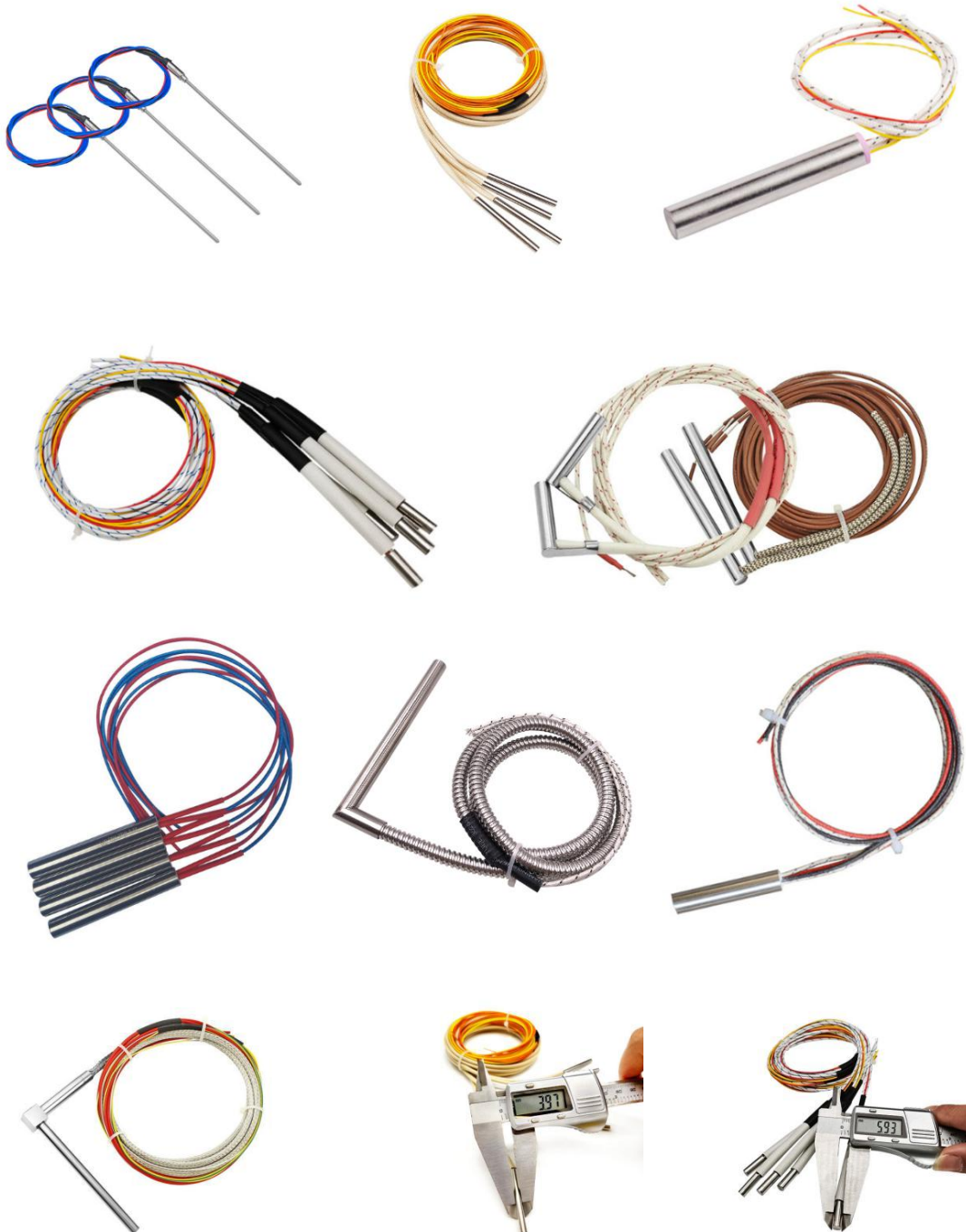



**Distributor :**

**Energy Power Save CO.,LTD**

Address : 442/2 Chan Road, Thung Watdon Sathon Bangkok Thailand 10120

Tel : +66 (02 ) 114 7145 - 9 Auto 5Line [www.7-mars.com](http://www.7-mars.com) Mobile Phone : +66 (089) 006 0906 Email : [info@7-mars.com](mailto:info@7-mars.com)

## Tubular Heater

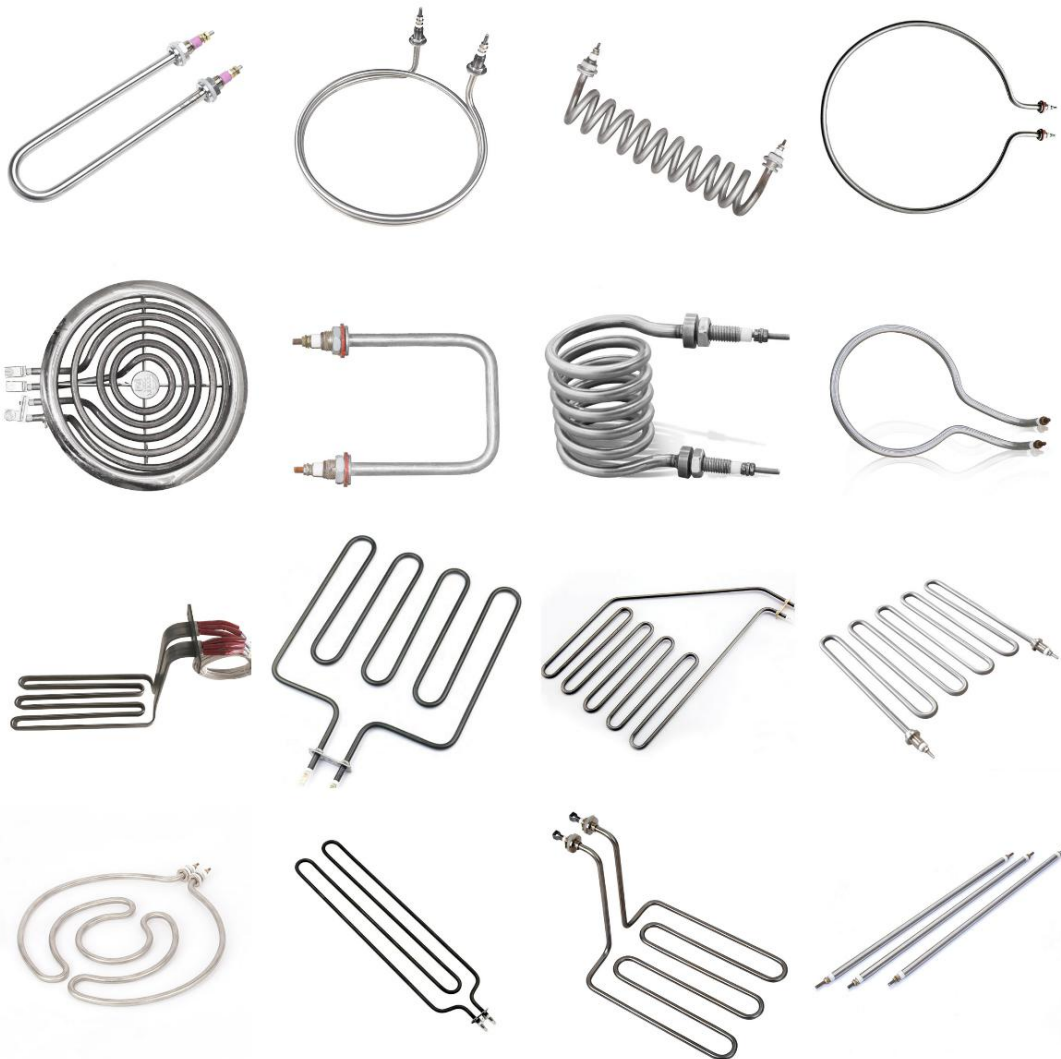



**Distributor :**

**Energy Power Save CO.,LTD**

Address : 442/2 Chan Road, Thung Watdon Sathon Bangkok Thailand 10120

Tel : +66 (02 ) 114 7145 - 9 Auto 5Line [www.7-mars.com](http://www.7-mars.com) Mobile Phone : +66 (089) 006 0906 Email : [info@7-mars.com](mailto:info@7-mars.com)

---



Tubular heater is a coiled heating wire (resistance wire) placed in a metal tube, and insulation powder (MgO) with good heat resistance, thermal conductivity and insulation is filled around it and the gaps to generate heat. Both ends of the wire are provided with lead rods or lead wires to be connected out.

It has the characteristics of simple structure, high mechanical strength, high thermal efficiency, safety and reliability, easy installation and long service life. It is widely used in all kinds of saltpeter tanks, water tanks, oil tanks,

**Distributor :****Energy Power Save CO.,LTD**

Address : 442/2 Chan Road, Thung Watdon Sathon Bangkok Thailand 10120

Tel : +66 (02 ) 114 7145 - 9 Auto 5Line www.7-mars.com Mobile Phone : +66 (089) 006 0906 Email : info@7-mars.com

acid-base tanks, fusible metal melting furnaces, air heating furnaces, drying furnaces, drying ovens, hot press molds and other devices.

## Technical parameters

<b>Rated voltage</b>	110V/220V/380V/Customizable
<b>Leakage current</b>	<0.5MA
<b>Power tolerance</b>	±3%
<b>Insulation resistance</b>	30 Ω
<b>Electric strength</b>	Cold state withstand voltage AC working at 1500V 50Hz for 1 minute without breakdown
<b>Thermal insulation</b>	AC work 1000V 50Hz for 1 minute without breakdown
<b>Resistance heating wire</b>	NiCr 80/20 wire
<b>Sheath Material</b>	Seamless SS304/316/321/ Incoloy800/840 alloy, etc.
<b>Voltages available</b>	12V/24V/36V/110V/220V/240V/380V/418V
<b>Wattage Tolerance</b>	±3%
<b>Resistance tolerance</b>	±3%
<b>Length tolerance</b>	± 2% or 3.2mm (1/8")
<b>Diameter</b>	From 2.0mm to 30mm
<b>Diameter tolerance</b>	+0.05mm ~0.1mm (+.002" -.004")
<b>Shapes</b>	<b>U-shaped, W-shaped, I-shaped, L-shaped, Back-shaped, Round and other non-standard shapes available</b>

## Application:

- Electric Ovens & Dryers
- Water and Oil Heating Appliances
- Packaging machineries
- Vending Machines
- Dies and Tools
- Sauna heater
- Sterilization equipment



**Distributor :**

**Energy Power Save CO.,LTD**

Address : 442/2 Chan Road, Thung Watdon Sathon Bangkok Thailand 10120

Tel : +66 (02 ) 114 7145 - 9 Auto 5Line www.7-mars.com Mobile Phone : +66 (089) 006 0906 Email : info@7-mars.com

- Kitchen equipments
- Medical equipments
- Heat accumulating equipments

.....



Figure 1A

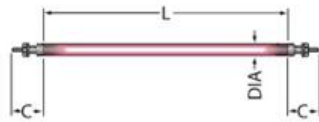

Figure 2A

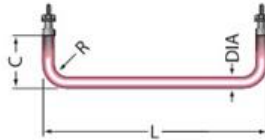

Figure 3A

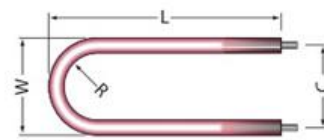

Figure 4A

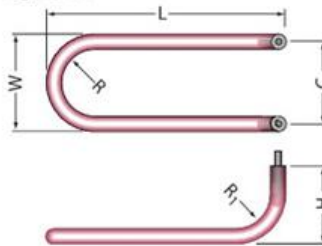

Figure 5A

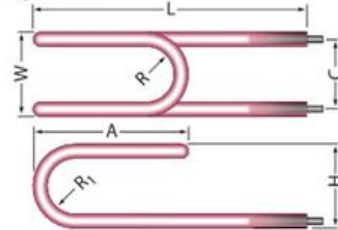

Figure 6A

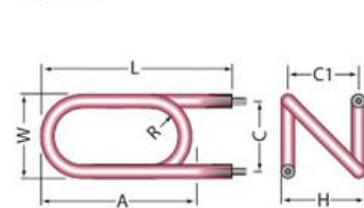

Figure 7A

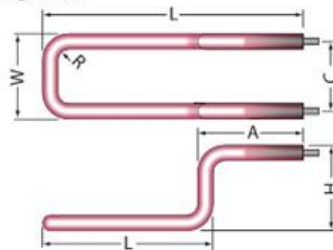

Figure 8A

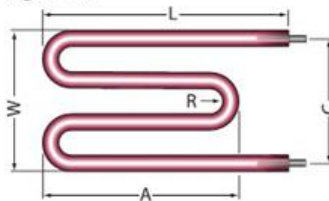
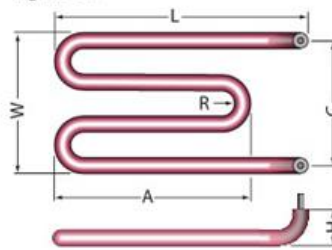

Figure 9A





**Distributor :**

**Energy Power Save CO.,LTD**

Address : 442/2 Chan Road, Thung Watdon Sathon Bangkok Thailand 10120

Tel : +66 (02) 114 7145 - 9 Auto 5Line [www.7-mars.com](http://www.7-mars.com) Mobile Phone : +66 (089) 006 0906 Email : [info@7-mars.com](mailto:info@7-mars.com)

Figure 10A

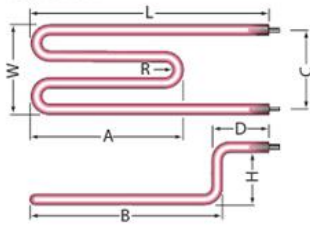

Figure 11A

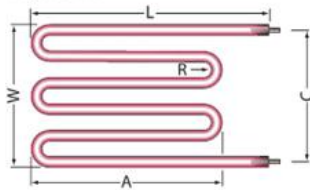

Figure 12A

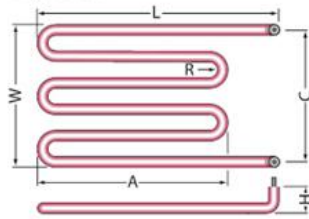

Figure 13A

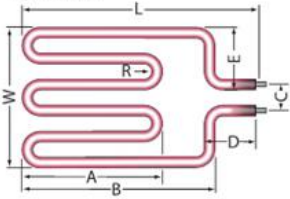

Figure 14A

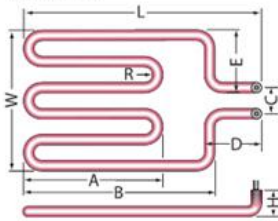

Figure 15A

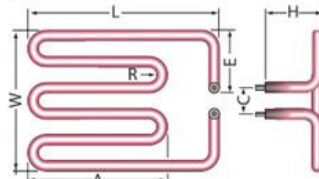

Figure 16A

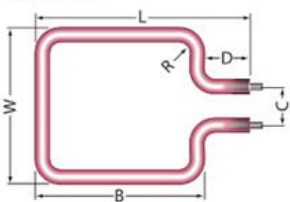

Figure 17A

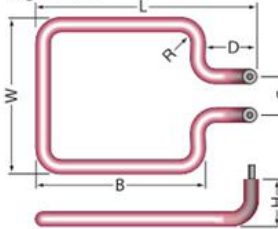

Figure 18A

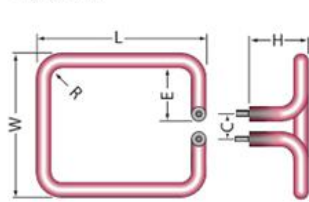

Figure 19A

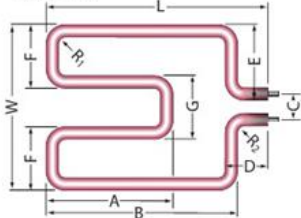

Figure 20A

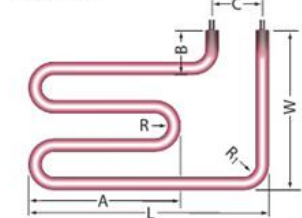

Figure 21A

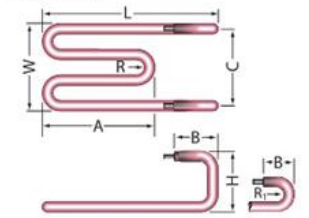

Figure 21A-1

Figure 22A

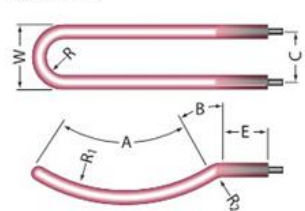

Figure 23A

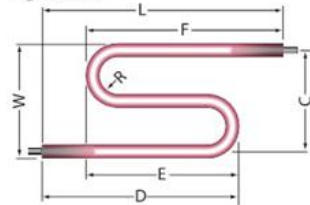

Figure 24A

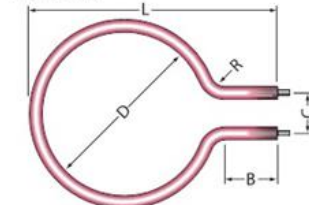

Figure 25A

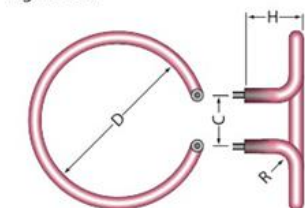

Figure 26A

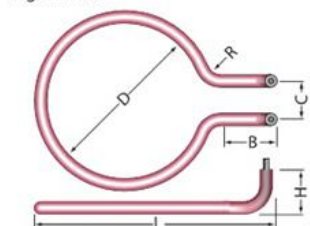
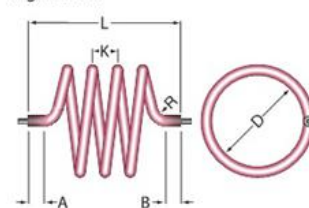

Figure 27A





**Distributor :**

**Energy Power Save CO.,LTD**

Address : 442/2 Chan Road, Thung Watdon Sathon Bangkok Thailand 10120

Tel : +66 (02 ) 114 7145 - 9 Auto 5Line [www.7-mars.com](http://www.7-mars.com) Mobile Phone : +66 (089) 006 0906 Email : [info@7-mars.com](mailto:info@7-mars.com)

## Immersion Thread/Flange Heater



Immersion Thread/Flanged Heater rod (electric heating tube) is a seamless stainless steel tube as the shell, and spiral electric heating alloy wires (nickel-chromium, iron-chromium alloy) are uniformly distributed along the central axis of the tube. It is made of advanced production equipment and through strict quality test. It has the advantages of good heating efficiency, uniform temperature, high temperature resistance, corrosion resistance, and good safety performance, long-time service life, etc characteristic.

It can be widely used for heating water, oil, air, nitrate solution, acid solution, alkali solution and low melting point metals processing (aluminum, zinc, tin, babbitt alloy), plastic processing & packaging machinery or other static or flowing air environment and widely used in machinery industry, gas/air industry, textiles industry, non woven fabric industry, home appliances, etc.





**Distributor :**

**Energy Power Save CO.,LTD**

Address : 442/2 Chan Road, Thung Watdon Sathon Bangkok Thailand 10120

Tel : +66 (02) 114 7145 - 9 Auto 5Line www.7-mars.com Mobile Phone : +66 (089) 006 0906 Email : info@7-mars.com

## Technical parameters

<b>Voltage</b>	12V ~ 600V AC Available
<b>Wattage</b>	1KW~2000KW/Customizable
<b>Immersion Length</b>	50mm-1000mm /Customizable
<b>Sheath Material</b>	Seamless SS304, 316L, 310S /T2 Copper/Incoloy800,840/Customizable
<b>Screw Thread size</b>	G / NPT / BSPP Thread 1" 1 1/4" 1 1/2" 2" etc /Customizable
<b>Round Flange size</b>	DN40/DN50/DN80/DN120/DN150/DN200,etc/Custo mizable
<b>Terminal Cover Material</b>	Stainless steel/Nylon /Plastic,etc
<b>Resistance wire material</b>	0Cr25Al5;0Cr21Al6Nb;0Cr27Al7Mo2;Cr20Ni80;GH 140
<b>Wattage density</b>	(High/Middle/Low)1~25w/cm <sup>2</sup>
<b>Pipe diameter</b>	6mm,6.5mm,8mm,10mm,12mm,14mm,16mm,20m m/Customizable

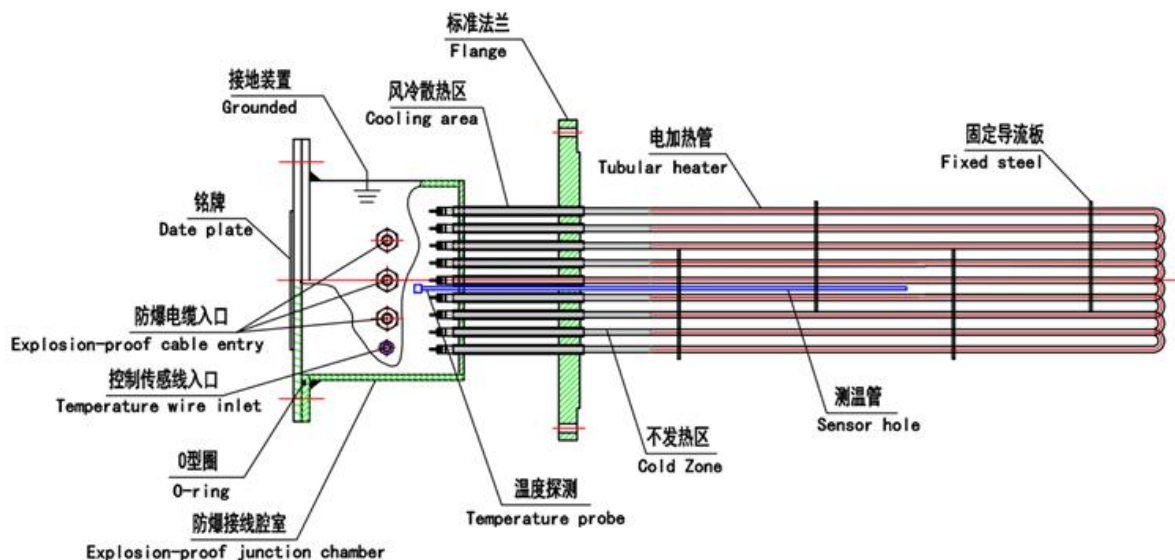



**Distributor :**

**Energy Power Save CO.,LTD**

Address : 442/2 Chan Road, Thung Watdon Sathon Bangkok Thailand 10120

Tel : +66 (02 ) 114 7145 - 9 Auto 5Line [www.7-mars.com](http://www.7-mars.com) Mobile Phone : +66 (089) 006 0906 Email : [info@7-mars.com](mailto:info@7-mars.com)

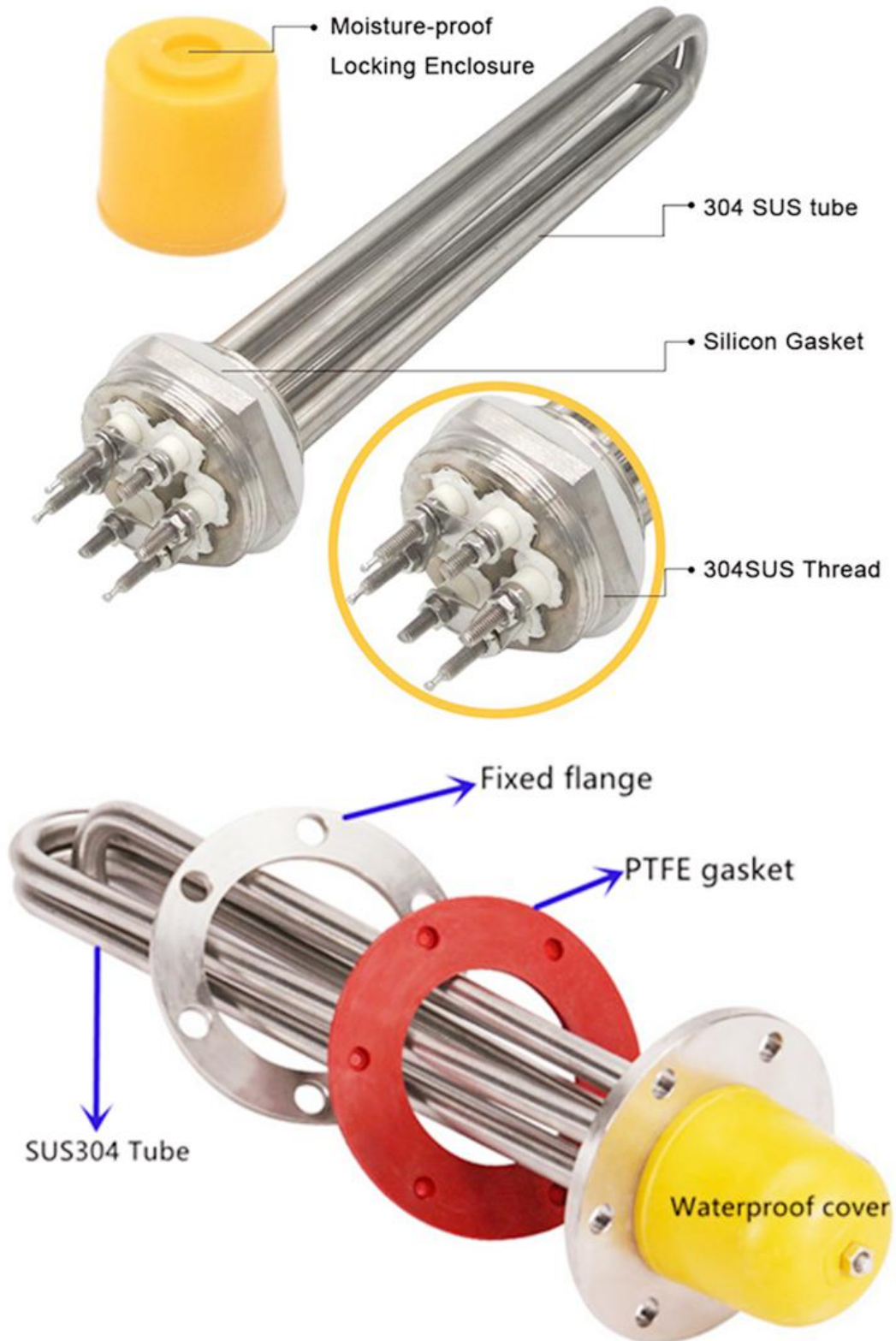

- Rapid heating
- Heat evenly

- Fast delivery
- Factory outlet

- Full specifications
- Good performance



**Distributor :**

**Energy Power Save CO.,LTD**

Address : 442/2 Chan Road, Thung Watdon Sathon Bangkok Thailand 10120

Tel : +66 (02 ) 114 7145 - 9 Auto 5Line [www.7-mars.com](http://www.7-mars.com) Mobile Phone : +66 (089) 006 0906 Email : [info@7-mars.com](mailto:info@7-mars.com)

## Installation Method

### Method 1: Side installation

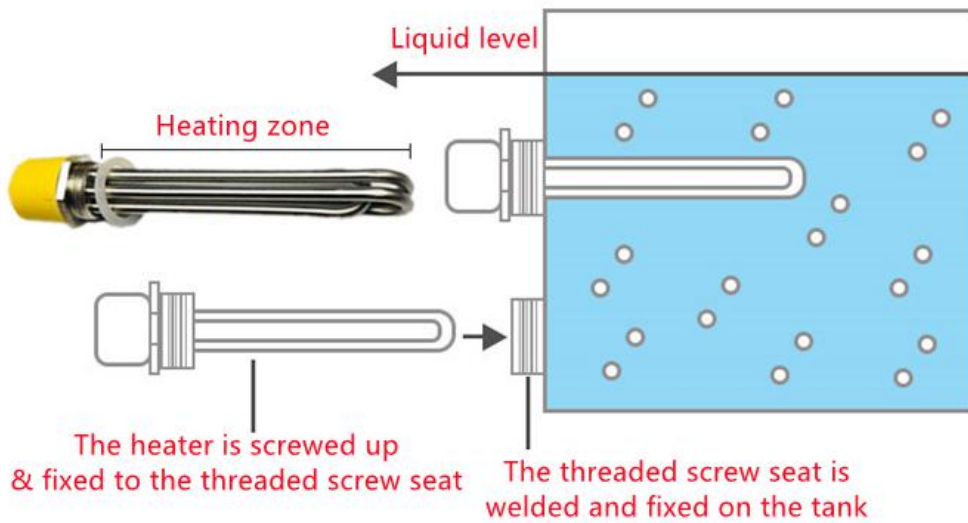

### Method 2: Top Installation

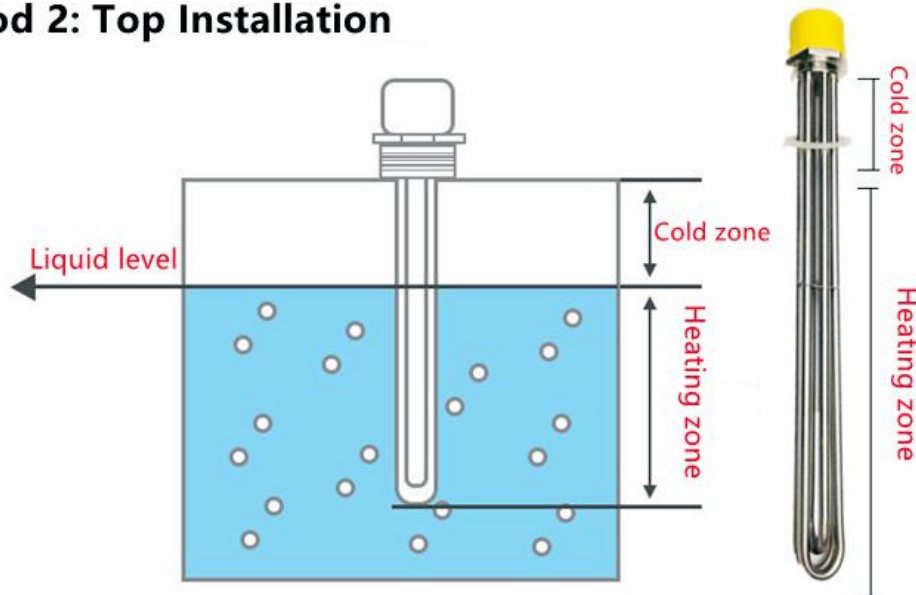



**Distributor :**

**Energy Power Save CO.,LTD**

Address : 442/2 Chan Road, Thung Watdon Sathon Bangkok Thailand 10120

Tel : +66 (02 ) 114 7145 - 9 Auto 5Line [www.7-mars.com](http://www.7-mars.com) Mobile Phone : +66 (089) 006 0906 Email : [info@7-mars.com](mailto:info@7-mars.com)





**Distributor :**

**Energy Power Save CO.,LTD**

Address : 442/2 Chan Road, Thung Watdon Sathon Bangkok Thailand 10120

Tel : +66 (02 ) 114 7145 - 9 Auto 5Line [www.7-mars.com](http://www.7-mars.com) Mobile Phone : +66 (089) 006 0906 Email : [info@7-mars.com](mailto:info@7-mars.com)

---





**Distributor :**

**Energy Power Save CO.,LTD**

Address : 442/2 Chan Road, Thung Watdon Sathon Bangkok Thailand 10120

Tel : +66 (02 ) 114 7145 - 9 Auto 5Line [www.7-mars.com](http://www.7-mars.com) Mobile Phone : +66 (089) 006 0906 Email : [info@7-mars.com](mailto:info@7-mars.com)

---

**Application:**

- Hot water storage tanks
- Warming equipment
- Oil Preheating
- Food processing equipment
- Cleaning and Rinsing Tanks
- Heat transfer systems
- Process air equipment
- Boiler equipment
- Pipeline equipment fluid heating
- Antifreeze protection for any fluid

.....





**Distributor :**

**Energy Power Save CO.,LTD**

Address : 442/2 Chan Road, Thung Watdon Sathon Bangkok Thailand 10120

Tel : +66 (02 ) 114 7145 - 9 Auto 5Line [www.7-mars.com](http://www.7-mars.com) Mobile Phone : +66 (089) 006 0906 Email : [info@7-mars.com](mailto:info@7-mars.com)



**ELECTRIC  
BOILER**



**PETROLEUM  
CHEMICAL  
INDUSTRY**



**WATER  
TANK**



**HEATING  
INSULATION**

It is suitable for heating air, oil, water, chemical medium, hot pressing die, melting salt, alkali and low melting point alloy, etc. With high thermal efficiency, long service life, high mechanical strength, easy installation, safe and reliable



**Distributor :**

**Energy Power Save CO.,LTD**

Address : 442/2 Chan Road, Thung Watdon Sathon Bangkok Thailand 10120

Tel : +66 (02 ) 114 7145 - 9 Auto 5Line [www.7-mars.com](http://www.7-mars.com) Mobile Phone : +66 (089) 006 0906 Email : [info@7-mars.com](mailto:info@7-mars.com)

## Diesel Parking Heater



The diesel parking heater is an on-board heating device that is independent of the car engine, and has its own independent fuel pipeline, circuit, combustion heating device, and control device. Without starting the engine, the car engine and the cab parked in the low temperature and cold



**Distributor :****Energy Power Save CO.,LTD**

Address : 442/2 Chan Road, Thung Watdon Sathon Bangkok Thailand 10120

Tel : +66 (02 ) 114 7145 - 9 Auto 5Line www.7-mars.com Mobile Phone : +66 (089) 006 0906 Email : info@7-mars.com

environment in winter can be warmed up. Completely eliminate the cold start wear of the car.

### Technical parameters

<b>Product</b>	Diesel air parking heater
<b>Fuel</b>	Diesel
<b>Burning rate</b>	100%
<b>Fuel consumption</b>	0.1-0.24L/H
<b>Working temperature</b>	RT~ 60 degrees
<b>Working voltage</b>	DC12V24V
<b>Power</b>	2KW 5KW
<b>Plateau mode</b>	The system automatically switches to the plateau mode
<b>Application</b>	Applicable to all kinds of cars, construction vehicles, excavators, trucks, vans, camping cars, RVs, yachts, commercial vehicles, buses, etc.
<b>Recommendations for use</b>	According to actual needs, it can be adjusted between 1000W and 5000W according to the size of the use area. The greater the power, the larger the heating area, and the maximum effective heating area does not exceed 30 square meters



**Distributor :**

**Energy Power Save CO.,LTD**

Address : 442/2 Chan Road, Thung Watdon Sathon Bangkok Thailand 10120

Tel : +66 (02 ) 114 7145 - 9 Auto 5Line [www.7-mars.com](http://www.7-mars.com) Mobile Phone : +66 (089) 006 0906 Email : [info@7-mars.com](mailto:info@7-mars.com)

## 1. Combined Split Heater





**Distributor :**

**Energy Power Save CO.,LTD**

Address : 442/2 Chan Road, Thung Watdon Sathon Bangkok Thailand 10120

Tel : +66 (02 ) 114 7145 - 9 Auto 5Line [www.7-mars.com](http://www.7-mars.com) Mobile Phone : +66 (089) 006 0906 Email : [info@7-mars.com](mailto:info@7-mars.com)

## 2. Portable All-in-one Heater





**Distributor :**

**Energy Power Save CO.,LTD**

Address : 442/2 Chan Road, Thung Watdon Sathon Bangkok Thailand 10120

Tel : +66 (02 ) 114 7145 - 9 Auto 5Line [www.7-mars.com](http://www.7-mars.com) Mobile Phone : +66 (089) 006 0906 Email : [info@7-mars.com](mailto:info@7-mars.com)



**Oil pump test**



**Product factory 100% inspection**



**Distributor :**

**Energy Power Save CO.,LTD**

Address : 442/2 Chan Road, Thung Watdon Sathon Bangkok Thailand 10120

Tel : +66 (02 ) 114 7145 - 9 Auto 5Line www.7-mars.com Mobile Phone : +66 (089) 006 0906 Email : info@7-mars.com

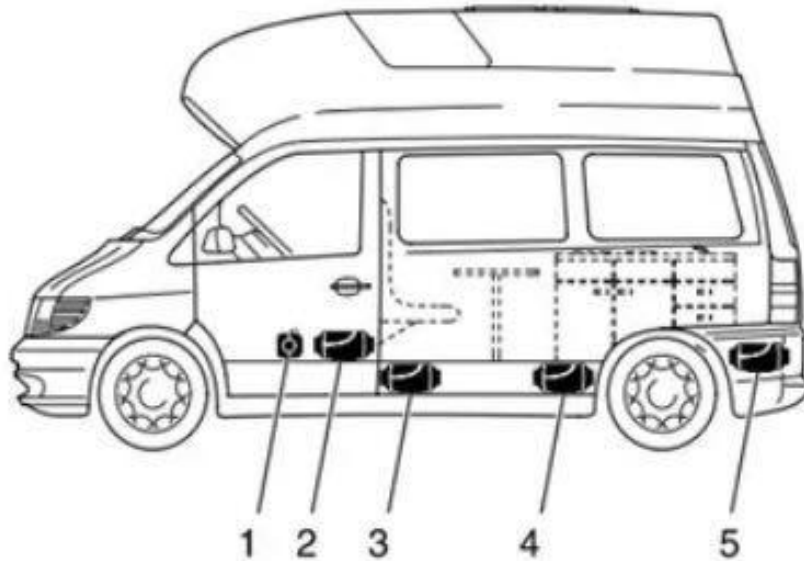

1 Heater in front of the passenger seat↵

2 Heater between the driver's seat and the passenger seat↵

3 Heater under the vehicle floor↵

4 Heater under the back seat↵

5 Heater in the boot↵

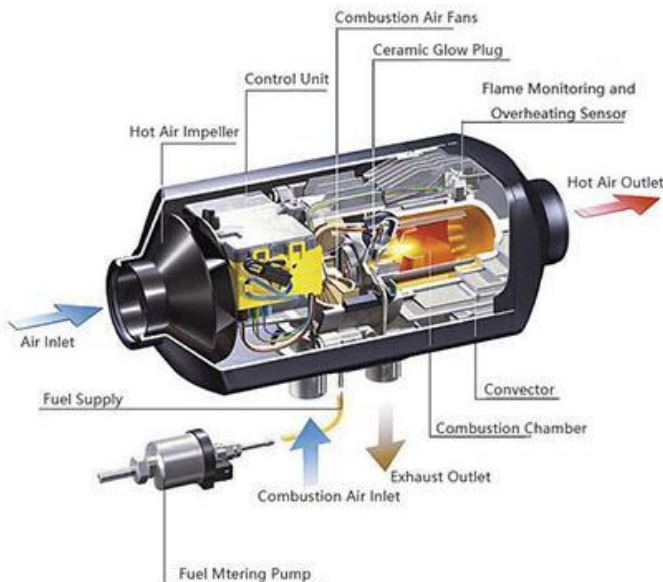

- \* Independent Heating System
- \* No changing of the vehicle battery and diesel
- \* Japan Kyocera Glow Plug
- \* Reliable & durable
- \* Temperature sensor
- \* Adjusting temperature automatically
- \* Two Operating Modes
- \* Manual and automatically control



**Distributor :**

**Energy Power Save CO.,LTD**

Address : 442/2 Chan Road, Thung Watdon Sathon Bangkok Thailand 10120

Tel : +66 (02 ) 114 7145 - 9 Auto 5Line www.7-mars.com Mobile Phone : +66 (089) 006 0906 Email : info@7-mars.com

## Display of Real Photography

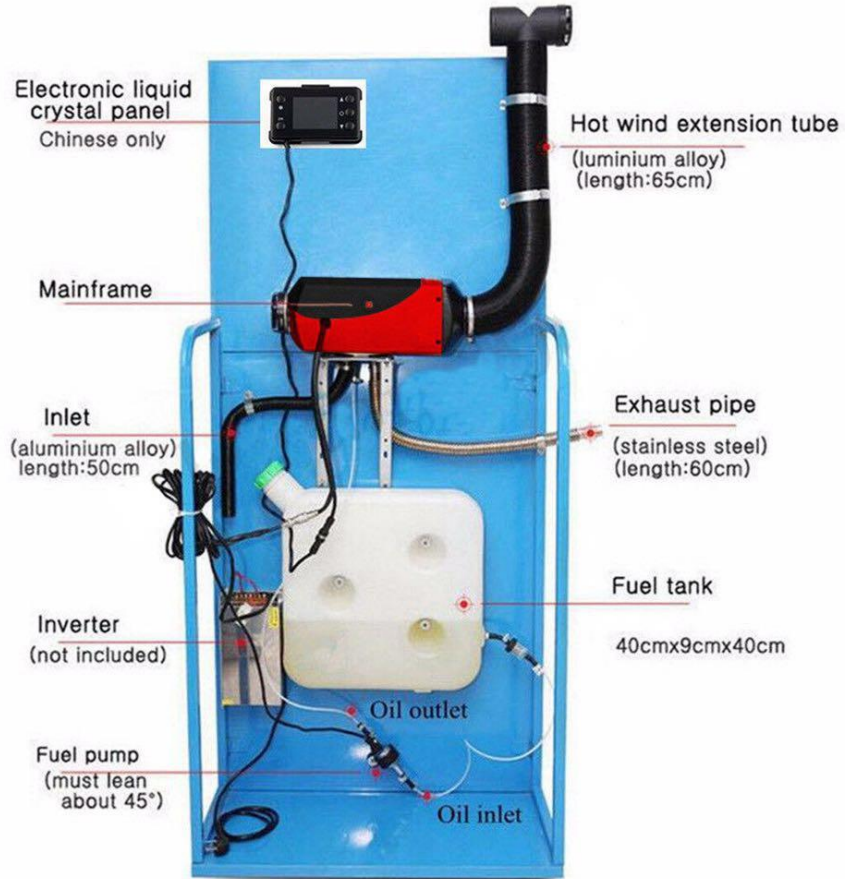



**Distributor :**

**Energy Power Save CO.,LTD**

Address : 442/2 Chan Road, Thung Watdon Sathon Bangkok Thailand 10120

Tel : +66 (02 ) 114 7145 - 9 Auto 5Line [www.7-mars.com](http://www.7-mars.com) Mobile Phone : +66 (089) 006 0906 Email : [info@7-mars.com](mailto:info@7-mars.com)

---

## Flexible Silicone Heater



The silicone rubber heaters have advantages of thinness, lightness and high flexibility. It can close contact with the heated objects and transfer heat to anywhere you need. The silicone rubber heater has advantages of high insulativity, since the insulating layers are made from silicone rubber and fiberglass fabric.



**Distributor :**

**Energy Power Save CO.,LTD**

Address : 442/2 Chan Road, Thung Watdon Sathon Bangkok Thailand 10120

Tel : +66 (02 ) 114 7145 - 9 Auto 5Line [www.7-mars.com](http://www.7-mars.com) Mobile Phone : +66 (089) 006 0906 Email : [info@7-mars.com](mailto:info@7-mars.com)

## Technical parameters

<b>Thickness</b>	Conventional 1.6mm-1.8mm, can be thicker
<b>Minimum size</b>	10mmx 20mm
<b>Maximum size</b>	1200mm x 10000mm
<b>Continuous use temperature</b>	$\leq 200^{\circ}\text{C}$
<b>Instantaneous maximum temperature resistance</b>	$250^{\circ}\text{C}$
<b>Temperature control</b>	Digital display/Manual knob temperature control available
<b>Power density</b>	0.01-2w/cm <sup>2</sup> , recommended power density: 0.1-0.8w/cm <sup>2</sup>
<b>Heating wire process</b>	Wire winding process and Etching process. The temperature difference of the winding process is 5-8 degrees, and the temperature difference of the etching process is within 5 degrees. The default winding process of this product
<b>Power deviation</b>	$\pm 3\%$
<b>Insulation withstand voltage</b>	1500V/min
<b>Insulation resistance</b>	$\geq 1000\text{M}\Omega$
<b>Mechanical compression</b>	100KG/cm <sup>2</sup>
<b>Wire tension</b>	80N
<b>Shape</b>	Any shape





**Distributor :**

**Energy Power Save CO.,LTD**

Address : 442/2 Chan Road, Thung Watdon Sathon Bangkok Thailand 10120

Tel : +66 (02 ) 114 7145 - 9 Auto 5Line [www.7-mars.com](http://www.7-mars.com) Mobile Phone : +66 (089) 006 0906 Email : [info@7-mars.com](mailto:info@7-mars.com)

## Variety Tempe-control Optional

20+ Years Customized Experience  
—Solutions to Heater Application—

### Digital Tempe-control

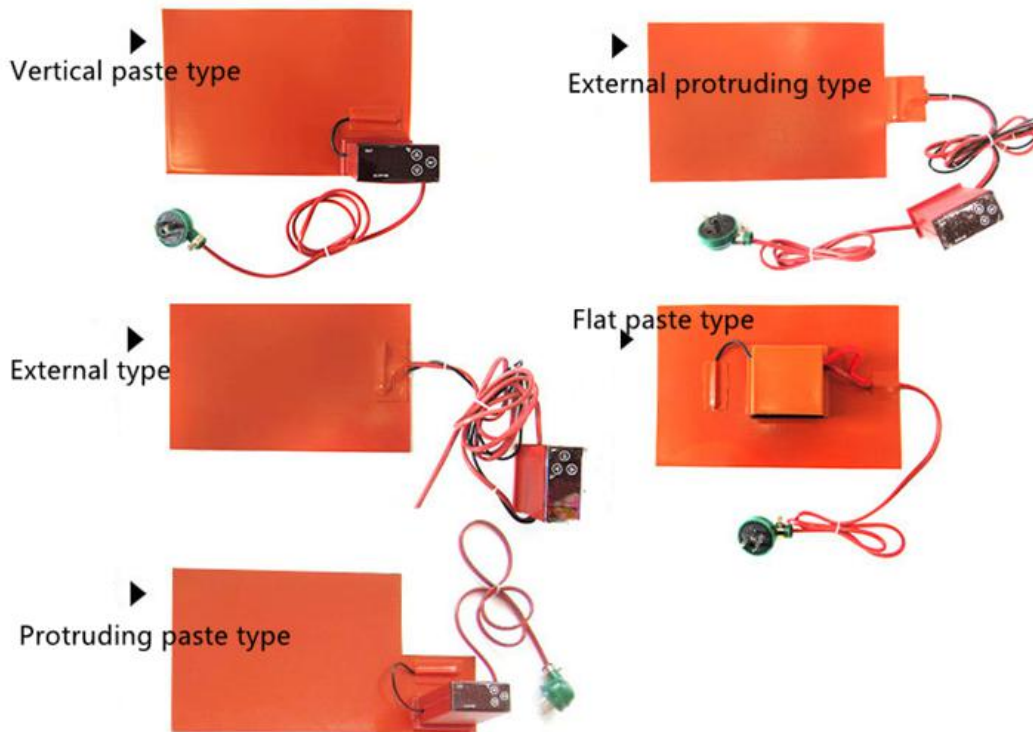



**Distributor :**

**Energy Power Save CO.,LTD**

Address : 442/2 Chan Road, Thung Watdon Sathon Bangkok Thailand 10120

Tel : +66 (02 ) 114 7145 - 9 Auto 5Line www.7-mars.com Mobile Phone : +66 (089) 006 0906 Email : info@7-mars.com

## Digital display/Knob temperature control optional

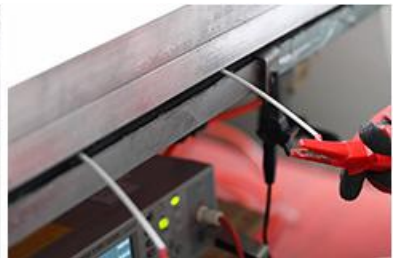



**Distributor :**

**Energy Power Save CO.,LTD**

Address : 442/2 Chan Road, Thung Watdon Sathon Bangkok Thailand 10120

Tel : +66 (02 ) 114 7145 - 9 Auto 5Line [www.7-mars.com](http://www.7-mars.com) Mobile Phone : +66 (089) 006 0906 Email : [info@7-mars.com](mailto:info@7-mars.com)

---



**Application:**

1. Heat transfer machine heating plate
2. Heating sheet for baking cup (pan) machine
3. Heater for oil drum
4. Heat-sealing machine heating sheet
5. Heating and heat preservation of medical equipment
6. Heating of chemical pipelines
7. Large equipment heating



**Distributor :**

**Energy Power Save CO.,LTD**

Address : 442/2 Chan Road, Thung Watdon Sathon Bangkok Thailand 10120

Tel : +66 (02 ) 114 7145 - 9 Auto 5Line [www.7-mars.com](http://www.7-mars.com) Mobile Phone : +66 (089) 006 0906 Email : [info@7-mars.com](mailto:info@7-mars.com)

---

8. Semiconductor processing equipment
9. Heating and heat preservation of various mechanical instruments
10. Medical equipment, such as blood analyzers, respiratory therapy devices and hydrotherapy
11. Antifreeze for military installations, aircraft instruments and hydraulic equipment
12. Battery heating
13. Food service equipment
14. Factory bonding and partial assembly? Any application that requires a soft shape or design
15. Analytical instruments
16. Aerospace
17. Antifreeze equipment
- 18.3D printing hot bed

.....



**Distributor :**

**Energy Power Save CO.,LTD**

Address : 442/2 Chan Road, Thung Watdon Sathon Bangkok Thailand 10120

Tel : +66 (02 ) 114 7145 - 9 Auto 5Line [www.7-mars.com](http://www.7-mars.com) Mobile Phone : +66 (089) 006 0906 Email : [info@7-mars.com](mailto:info@7-mars.com)

## Flexible Kapton Polyimide Heater

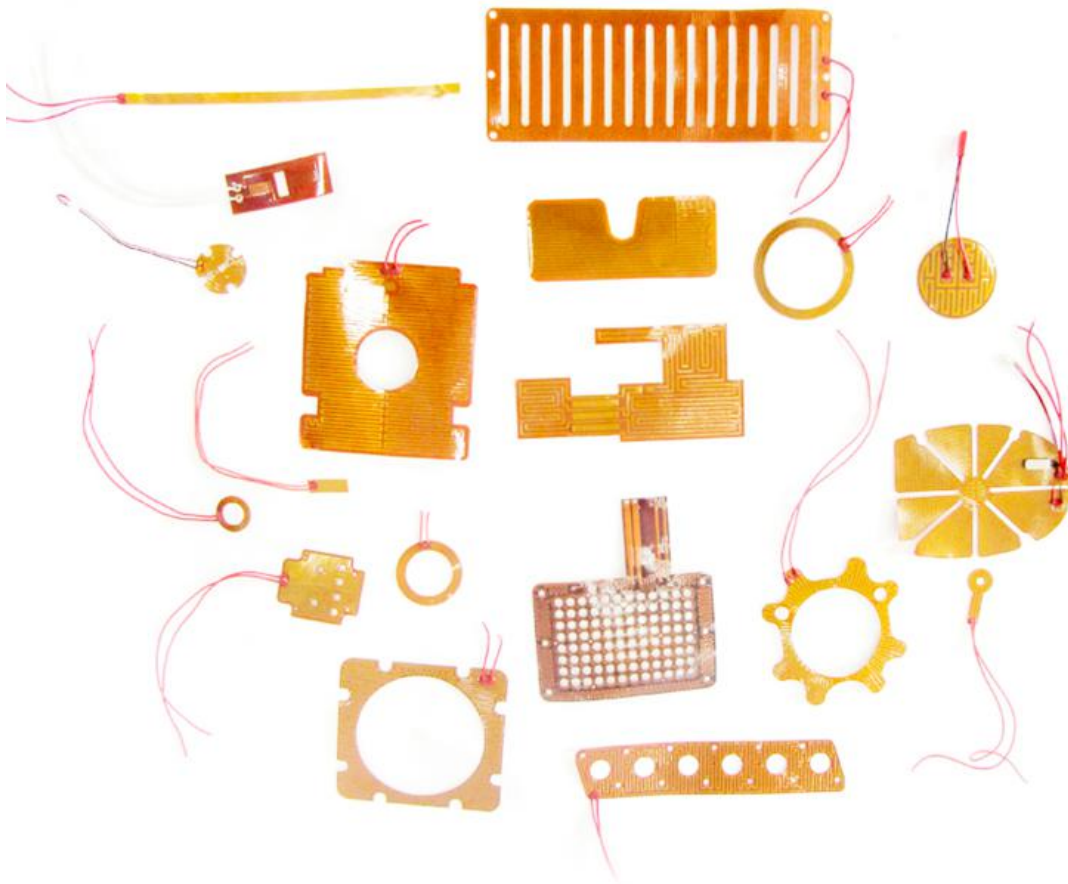

Polyimide heaters, also known as Kapton heaters, are made from Kapton, a polyimide film developed by DuPont. Polyimide heaters provide the thinnest profile of all flexible heaters, offer precise heat distribution, and excellent tensile strength. They work well in extreme heat environments or small spaces.



**Distributor :**

**Energy Power Save CO.,LTD**

Address : 442/2 Chan Road, Thung Watdon Sathon Bangkok Thailand 10120

Tel : +66 (02 ) 114 7145 - 9 Auto 5Line [www.7-mars.com](http://www.7-mars.com) Mobile Phone : +66 (089) 006 0906 Email : [info@7-mars.com](mailto:info@7-mars.com)

## Technical parameters

<b>Product Name</b>	Flexible Kapton Polyimide Film Heater
<b>Voltage Range</b>	1.5V~400V Available
<b>Power Density Range</b>	0.025W/cm <sup>2</sup> ~5W/cm <sup>2</sup> Available
<b>Lead Material</b>	Teflon, Kapton or Silicone Insulated Leads Available
<b>Heaters Thickness</b>	0.12mm~0.5 mm Available
<b>Heater Size</b>	Maximum 600mm*3000mm; Minimum 10mm*10mm
<b>Heating Material</b>	Etched Metal Foil
<b>Wattage Tolerance</b>	±3%
<b>Maximum Operating Temperature</b>	450F (230°C)
<b>Minimum Operating Temperature</b>	-319F (-195°C)
<b>Dielectric Strength</b>	1000 V AC





**Distributor :**

**Energy Power Save CO.,LTD**

Address : 442/2 Chan Road, Thung Watdon Sathon Bangkok Thailand 10120

Tel : +66 (02 ) 114 7145 - 9 Auto 5Line [www.7-mars.com](http://www.7-mars.com) Mobile Phone : +66 (089) 006 0906 Email : [info@7-mars.com](mailto:info@7-mars.com)





**Distributor :**

**Energy Power Save CO.,LTD**

Address : 442/2 Chan Road, Thung Watdon Sathon Bangkok Thailand 10120

Tel : +66 (02) 114 7145 - 9 Auto 5Line [www.7-mars.com](http://www.7-mars.com) Mobile Phone : +66 (089) 006 0906 Email : [info@7-mars.com](mailto:info@7-mars.com)

## Various Types & Specifications Available

20+ Years Experience  
—Solutions to Heater Application—

**01**

### Wiring Way

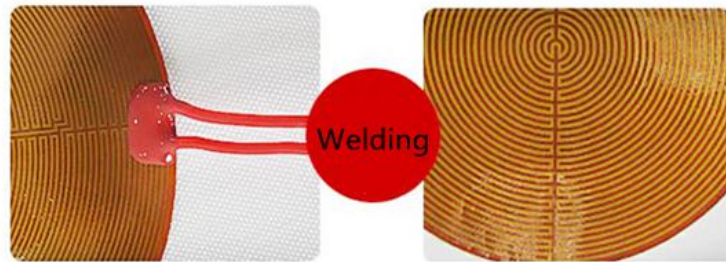

**02**

### Adhesive

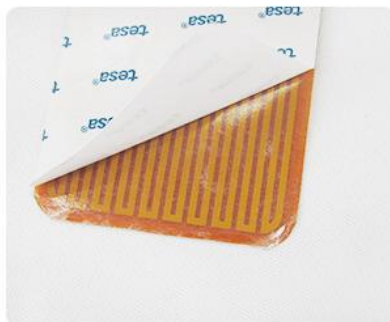

Tesa

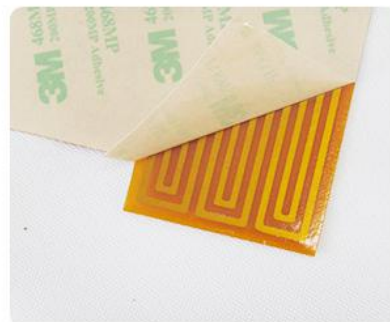

3M

Note: The default lead length of the product is 250mm; Without adhesive. If adhesive needed, please inform our staff when placing your order.





**Distributor :**

**Energy Power Save CO.,LTD**

Address : 442/2 Chan Road, Thung Watdon Sathon Bangkok Thailand 10120

Tel : +66 (02 ) 114 7145 - 9 Auto 5Line [www.7-mars.com](http://www.7-mars.com) Mobile Phone : +66 (089) 006 0906 Email : [info@7-mars.com](mailto:info@7-mars.com)

## 03 Shaped Customizable

### Terminals

Various wiring terminals available. Terminals of specified models available

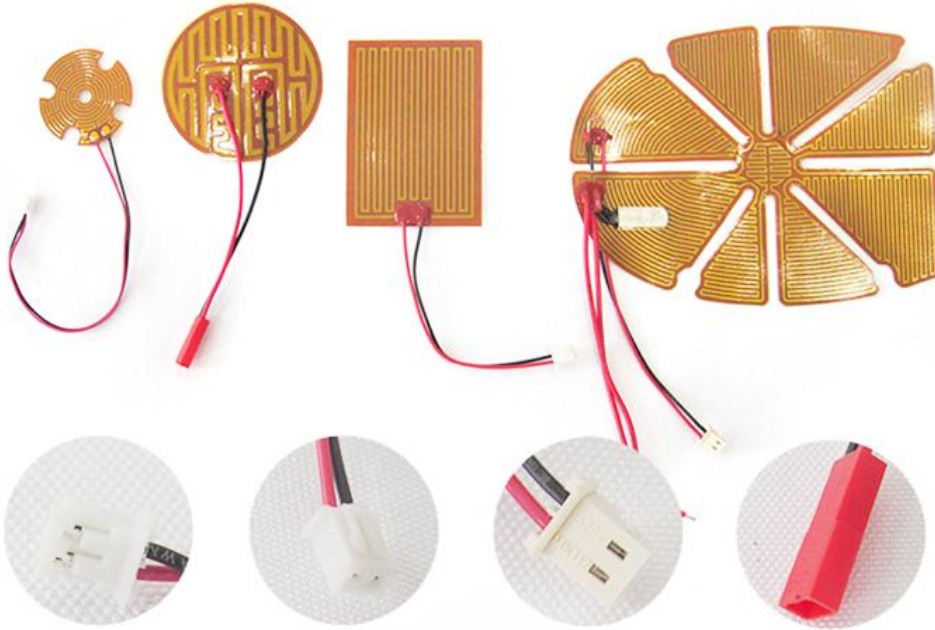

### Temperature measurement parts

Thermistor, PT100, thermocouple, etc. Available

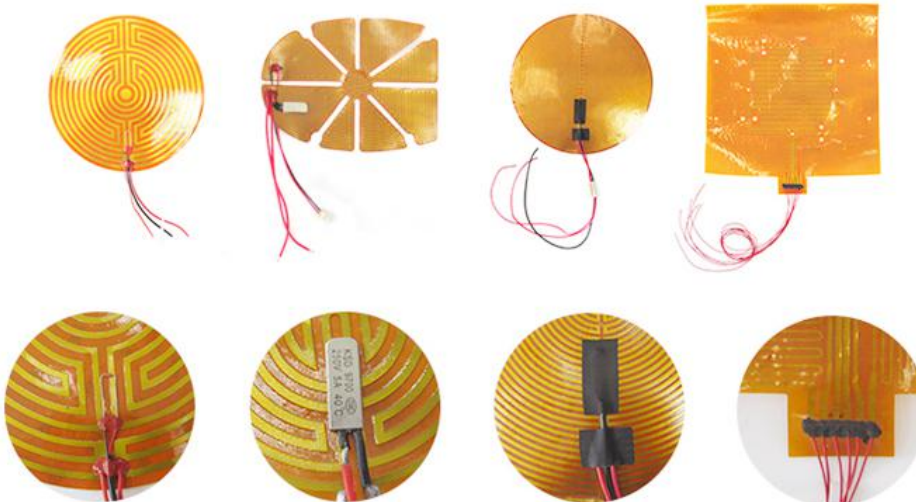



**Distributor :**

**Energy Power Save CO.,LTD**

Address : 442/2 Chan Road, Thung Watdon Sathon Bangkok Thailand 10120

Tel : +66 (02 ) 114 7145 - 9 Auto 5Line [www.7-mars.com](http://www.7-mars.com) Mobile Phone : +66 (089) 006 0906 Email : [info@7-mars.com](mailto:info@7-mars.com)

## Widely Product Applications

20+ Years Experience  
-Solutions to Heater Application-



Rearview mirror heating film  
can effectively remove rain,  
fog, frost, ice



Hand warmer heating sheet  
fast heating, stable performance  
accurate temperature control



Straight/Curler heating sheet  
fast heating, stable performance  
precise temperature control



Warm vest heating sheet  
fast heating, stable  
performance, accurate  
temperature control



Small home appliances  
Beauty equipment  
Massage equipment, etc.



Hand warmers  
Electric blankets  
Heating shoes  
Heating clothing, etc.



Medical equipment  
Blood pressure analyzer,  
etc.



**Distributor :**

**Energy Power Save CO.,LTD**

Address : 442/2 Chan Road, Thung Watdon Sathon Bangkok Thailand 10120

Tel : +66 (02 ) 114 7145 - 9 Auto 5Line [www.7-mars.com](http://www.7-mars.com) Mobile Phone : +66 (089) 006 0906 Email : [info@7-mars.com](mailto:info@7-mars.com)

## Band Heater



Band Heater mainly include Ceramic band heater, Mica band heater,



**Distributor :**

**Energy Power Save CO.,LTD**

Address : 442/2 Chan Road, Thung Watdon Sathon Bangkok Thailand 10120

Tel : +66 (02 ) 114 7145 - 9 Auto 5Line [www.7-mars.com](http://www.7-mars.com) Mobile Phone : +66 (089) 006 0906 Email : [info@7-mars.com](mailto:info@7-mars.com)

Brass nozzle band heater, Cast aluminum band heater and Coil heater. It is a kind of heater with high temperature and long life. In modern industry, it is widely used in high-temperature heating stoves, semiconductor engineering, glass, ceramics and wire engineering and other fields. Especially in the chemical and chemical fiber, engineering plastics, plastic machinery, electronics, medicine, food and various pipeline heating industries.

### Technical parameters

<b>Product Name</b>	Band Heaters
<b>Voltage</b>	120V 220V 230V 240V 480V etc (under customer request)
<b>Working temperature</b>	RT~600 degree celsius
<b>Resistance Wire Type</b>	NiCr 80/20
<b>Mini Diamter</b>	25mm
<b>Surface unit power</b>	2.5watts/cm <sup>2</sup> ~ maximum 6.5 watts/cm <sup>2</sup>
<b>Gap Locking Mechanism Type</b>	Flange, Barrel Nuts or None





**Distributor :**

**Energy Power Save CO.,LTD**

Address : 442/2 Chan Road, Thung Watdon Sathon Bangkok Thailand 10120

Tel : +66 (02 ) 114 7145 - 9 Auto 5Line www.7-mars.com Mobile Phone : +66 (089) 006 0906 Email : info@7-mars.com

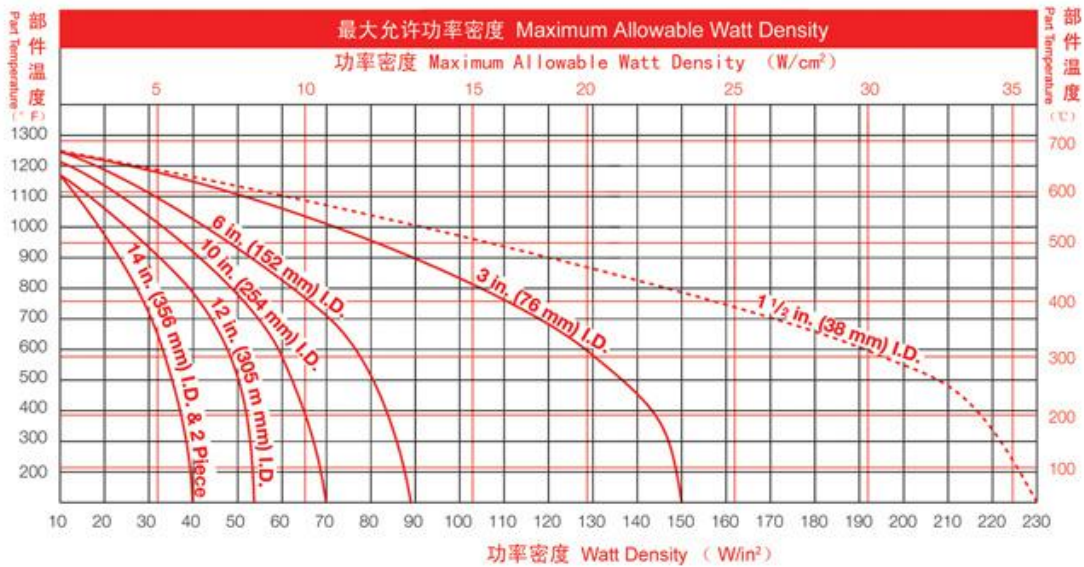
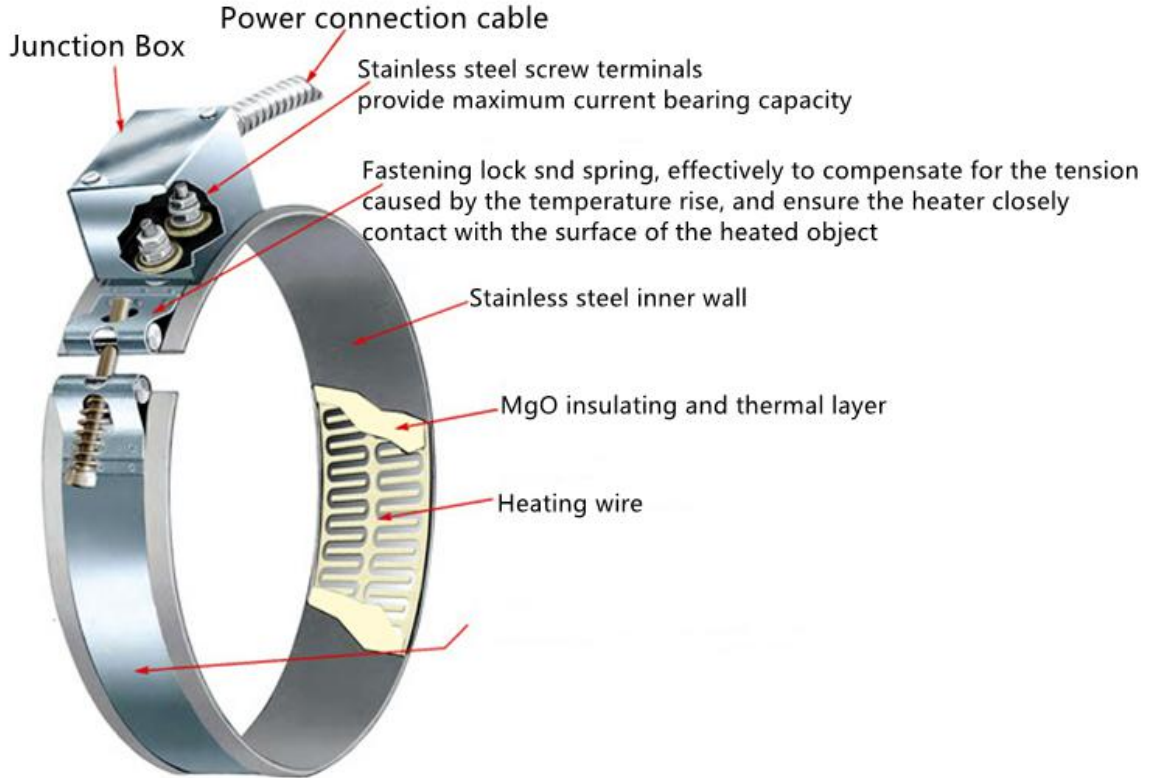



**Distributor :**

**Energy Power Save CO.,LTD**

Address : 442/2 Chan Road, Thung Watdon Sathon Bangkok Thailand 10120

Tel : +66 (02 ) 114 7145 - 9 Auto 5Line [www.7-mars.com](http://www.7-mars.com) Mobile Phone : +66 (089) 006 0906 Email : [info@7-mars.com](mailto:info@7-mars.com)



**Application:**

1. Plastic injection moulding machine
2. Hollow shaping machine/Blow-molding machine
3. Extrusion machine/Co-extrusion line
4. Raw material processing equipment
5. Pelletizing equipment
6. Granular machine
7. Non-woven meltblown fabric equipment
8. All types of plastics processing machines

.....



**Distributor :**

**Energy Power Save CO.,LTD**

Address : 442/2 Chan Road, Thung Watdon Sathon Bangkok Thailand 10120

Tel : +66 (02 ) 114 7145 - 9 Auto 5Line [www.7-mars.com](http://www.7-mars.com) Mobile Phone : +66 (089) 006 0906 Email : [info@7-mars.com](mailto:info@7-mars.com)



**Injection molding machinery**

**Extrusion machinery**

**Medical machinery**

**Film blowing machinery**

**Tape cutting machine**



**Distributor :**

**Energy Power Save CO.,LTD**

Address : 442/2 Chan Road, Thung Watdon Sathon Bangkok Thailand 10120

Tel : +66 (02 ) 114 7145 - 9 Auto 5Line [www.7-mars.com](http://www.7-mars.com) Mobile Phone : +66 (089) 006 0906 Email : [info@7-mars.com](mailto:info@7-mars.com)