

HHD-Sicherungen

Hochspannungs-Hochleistungs-
Sicherungen nach DIN 43 625

HHD Fuses

High-Voltage
Fuses acc. DIN 43 625

Einleitung /
Introduction

Technische Daten nach Baureihen /
Technical Data Types of Fuses

Technische Daten Sicherungs-Unterteile /
Technical Data Fuse Bases

Zubehör / Accessories

Verpackungseinheit / Gewicht siehe Seite 202 + 203
Packing unit / Weight see page 202 + 203

HHD-Sicherungen Hochspannungs-Hochleistungs- Sicherungen nach DIN 43 625

HHD Fuses High-Voltage Fuses acc. DIN 43 625

Einleitung Introduction



1 Einsatzgebiete, Baureihen

Vorbemerkung

SIBA Hochspannungs-Hochleistungssicherungen sind Sicherungen zum Schutz von Netzstationen bis 40,5 kV.

Die Sicherungseinsätze dieses Abschnitts erfüllen die Anforderungen folgender nationaler und internationaler Normen:

- DIN 43 625
- BS 2692-1
- ESI 12-8

Die Sicherungen sind nach dem bewährten Konzept aller SIBA HH-Sicherungseinsätze aufgebaut. So wird zur druckfesten Kapselung hochwertiges techn. Porzellan eingesetzt. Das Kontaktmaterial besteht aus silberlegiertem, hochleitendem Kupfer. Um engere Toleranzen bei den Strom-Zeit-Kennlinien sowie niedrigere Durchlassströme zu erreichen, werden die Schmelzleiter aus Feinsilber mit Ausstanzungen versehen. Der Quarzsand zum Löschen von Lichtbögen ist in Bezug auf seine Zusammensetzung, Korngröße und seines Feuchtigkeitsgehalts besonderen Überwachungskriterien unterworfen.

Sicherungen für den Transformator- und Kondensatorschutz

HHD-B (Seite 32ff)

Bei dieser Baureihe handelt es sich um eine klassische Standard-Teilbereichs-Sicherung für den Transformator-Schutz, sie erfüllt die speziellen Anforderungen, die an das Einsatzgebiet gestellt werden. Als Teilbereichs-Sicherung schaltet sie Ströme ab dem 3-4fachen des Bemessungsstroms bis zum Bemessungsausschaltstrom ab, zentrales Einsatzgebiet ist daher der Kurzschlusschutz. Die Sicherung ist erhältlich für die genormten Bemessungsspannungsbereiche 3/7,2 kV; 6/12 kV; 10/17,5 kV; 10/24 kV; 20/36 kV sowie für die Bemessungsspannungen 27, 38,5 und 40,5 kV.

1 Application range, types

Preliminary note

SIBA HV-fuses are fuses for the protection of substations up to 40,5 kV.

The fuse-links of this section comply with the following national and international standards:

- DIN 43 625
- BS 2692-1
- ESI 12-8

Design and construction of these fuse-links follow the well-proven concept of all SIBA high-voltage fuse-links. For pressure resistant encapsulation, high grade techn. porcelain is used. Contact material consists of silver plated high conductivity copper. The pure silver melting elements have appropriate notches to ensure small time-current curve tolerances and low let-through currents. The arc quenching quartz sand is subject to particular survey criteria regarding its composition, grain size and humidity content.

Fuses for the protection of transformers and capacitors

HHD-B (page 32ff)

A classical standard back-up fuse for transformer protection, this type series meets the special requirements set for the area of application. As a back-up fuse, it interrupts currents from 3 to 4 times the rated current all the way to the rated breaking current, making short-circuit protection its main area of application. HHD-B fuses are available for rated voltage ranges of 3/7.2 kV, 6/12 kV, 10/17.5 kV, 10/24 kV and 20/36 kV and also cover rated voltages of 17, 38.5 and 40.5 kV.

HHD-BSSK (Seite 70ff)

Diese Ausführung einer SIBA-DIN-Hochspannungs-Sicherung ist für das Zusammenwirken mit Schaltanlagen optimiert. Sie wurde ausgelegt für kurze Schalteröffnungszeiten und kleine Übernahmeströme. SIBA HHD-BSSK-Sicherungen können unter bestimmten Bedingungen zusammen mit Lastschalter/Sicherungskombinationen bei Transformatoren größerer Leistung eingesetzt werden. Die Sicherung ist erhältlich in den Bemessungsspannungsbereichen 6/12 kV; 10/24 kV und 20/36 kV.

HHD-G (Seite 78ff)

Diese SIBA-DIN-Hochspannungs-Sicherungen sind Vielbereichsicherungen. Sie schalten unter festgelegten Bedingungen alle Ströme ab, vom Bemessungsausschaltstrom bis herab zu dem Strom, der in einer Zeit von kürzer oder gleich einer Stunde zum Unterbrechen des Sicherungseinsatzes führt. Der Schmelzstrom bei einer Schmelzzeit von einer Stunde liegt meist zwischen dem 1,5 und 2-fachen Bemessungsstrom. Die Sicherung kommt daher als Kurzschluss-Schutz und in gewissen Bereichen als Überlastschutz zum Einsatz. HHD-G-Sicherungen bieten wir in den Bemessungsspannungsbereichen 6/12 kV und 10/24 kV an.

HHD-BSSK (page 70ff)

This SIBA DIN HV-fuse make has been specially designed to harmonize with switchgear installations. It was constructed for short fuse-initiated opening times of the switch and low take-over currents. Together with switch-fuse combinations, and under certain conditions, SIBA HHD-BSSK fuses can be used for transformers with higher power ratings. HHD-BSSK fuses are available for rated voltage ranges of 6/12 kV; 10/24 kV, and 20/36 kV.

HHD-G (page 78ff)

These SIBA DIN high-voltage fuses function as general purpose fuses. Under fixed conditions they interrupt all currents, from rated breaking currents all the way down to the current that in an hour or less triggers the fuse-link. At a melting time of one hour, the melting current usually lies between a multiple of 1.5 to 2 of the rated current. HHD-G fuses are therefore deployed for overload-protection purposes. We offer HHD-G fuse-links for rated current ranges of 6/12 kV and 10/24 kV.

Sicherungen für den Schutz von Motorstromkreisen**HHD-BM (Seite 82ff)**

In dieser Baureihe bieten wir Teilbereichssicherungen an, die sich für die Absicherung von Motorstromkreisen eignen. Diese Ausführung ist durch einen besonderen Schmelzleitaraufbau für die typischen zyklischen Belastungen im Motorkreis optimiert worden. Darüber hinaus ist die Leistungsabgabe deutlich niedriger als bei einer üblichen Hochspannungssicherung. Die Baureihe ist in den Bemessungsspannungsbereichen 3/3,6 kV; 3/7,2 kV und 6/12 kV erhältlich.

Fuses for the protection or motor circuits**HHD-BM (page 82ff)**

This type series consists of back-up fuses for motor circuit protection. Its fuse element has been specially optimized to deal with the cyclical loads typical for motor circuits. Moreover, power dissipation is much lower compared to commonly used HV fuses. We offer this type series for rated voltages of 3/3,6 kV; 3/7,2 kV and 6/12 kV.

HHD-BR (Seite 88ff)

Die Sicherungen der Baureihe BR (R steht für „R-rated“) wirken in gleicher Weise wie die HHD-BM-Sicherungen. Sie sind jedoch an die Norm ANSI C37.46 angepasst.

Die Sicherungen dieser Baureihe bieten wir im Bemessungsspannungsbereich 2,4-7,2 kV an.

Sicherungen für den Schutz von Spannungswandlern

HHD-BVT (Seite 90ff)

SIBA HHD-BVT-Sicherungen für den Schutz von Spannungswandlernetzen sind Teilbereichssicherungen und demnach zur Unterbrechung von Kurzschlussströmen vorgesehen. Auf Grund ihrer hohen Strombegrenzungseigenschaft isolieren sie den fehlerhaften Spannungswandler in wenigen Millisekunden vom Netz.

Teilweise werden die Sicherungseinsätze mit einem Schlagstift ausgestattet, welcher die Fernabfrage des Schaltzustandes erlaubt oder eine direkte Abschaltung über eine Freiauslösung ermöglicht.

Die Sicherungen werden mit Schlagstift bevorzugt in den Bemessungsstromstärken 2 A, 3,15 A und 4 A angeboten. Niedrigere Stromstärken ohne Schlagstift sind möglich.

Die Sicherungen im DIN-Aufbau werden im Durchmesser von 53 mm angeboten. Die Längen entsprechen den im Kapitel HHD-Sicherungen genannten Angaben der Vorzugstypen und sind in den Bemessungsspannungen 3/7,2 kV, 6/12 kV, 10/17,5 kV, 10/24 kV, 20/36 kV, 38,5 kV und 40,5 kV erhältlich.

2 Schlagstift

SIBA HH-Sicherungseinsätze sind mit einem Schlagstift unterschiedlicher Haltekräfte erhältlich:

- 80 N (Artikelnummer 30... 13) Basistype und
- 120 N (Artikelnummer 30... 14) Variante

Die Charakteristik beider Schlagstifte entspricht IEC 60282-1 / VDE 0670 Teil 4 und gehört zur Kategorie „mittel“.

Das Schlagmeldersystem ist über einen hochohmigen Nebenschmelzleiter angeschlossen. Nach dem Schmelzen der Hauptschmelzleiter zeigt der ausgelöste Schlagstift den Betriebsstatus der Sicherung an und kann einen Mikroschalter für die Fernmeldung und/oder einen Lasttrennschalter auslösen.

Kraft/Weg-Diagramme zu den Schlagstiften unterschiedlicher Haltekräfte finden Sie auf der Seite 26.

3 Temperaturbegrenzer

Alle SIBA HH-Sicherungseinsätze in der Ausführung mit Schlagmelder 80 N sind ausgerüstet mit einem integrierten Temperaturbegrenzer. Diese Schlagmelder haben folglich zwei Funktionen:

- Anzeige- und Schaltfunktion beim Ansprechen des Sicherungseinsatzes
- Schutz der Sicherungsbehälter von SF6-Anlagen gegen unzulässige Erwärmung.

Insbesondere SF6-isolierte Schaltanlagen fordern zusätzliche Schutzmaßnahmen gegen unzulässige Erwärmung von Anlagenteilen. Der integrierte Temperaturbegrenzer verhindert unzulässig hohe Temperaturen – unabhängig von ihrer Ursache – in gasisolierten oder eng gekapselten Schaltanlagen. Mit Hilfe eines Schmelzaktivators

HHD-BR (page 88ff)

Fuses of the type series BR (R stands for "R-rated") function in the same way as HHD-BM fuses, but are tailored to meet the ANSI C37.46 standard.

Fuses of this type series are on offer for rated voltages between 2.4 and 7.2 kV.

Fuses for the protection of potential transformer circuits

HHD-BVT (page 90ff)

SIBA HHD-BVT fuses for the protection of VT circuits are back-up fuses designed to interrupt short-circuit currents. Due to the high breaking currents, the fault current will be limited and finally quenched in a few milliseconds.

Some fuses include a striker pin for visual indication. This feature allows remote indication of the fuse operation or direct tripping of a circuit breaker.

Fuses with striker pins have rated voltages of 2 A, 3.15 A and 4 A. Lower rated voltages are possible without striker pin.

DIN-style fuses have a diameter of 53 mm and a length depending on the rated voltage. The preferred lengths can be found in selection HHD of our catalogue.

These fuses are available for a rated voltage of 3/7.2 kV, 6/12 kV, 10/17.5 kV, 10/24 kV, 20/36 kV, 38.5 kV and 40.5 kV.

2 Striker pin

SIBA HV fuse-links are available with striker pins of force:

- 80 N (Part No. 30 ... 13) basic-type and
- 120 N (Part No. 30 ... 14) variant-type

The characteristics of both striker pins correspond to IEC 60282-1, VDE 0670 Part 4, and are of the energy-category "medium".

The striker pin system is connected by means of a high resistance parallel conductor. After melting the main fuse elements, the striker pin indicates the operating status of the fuse and can actuate a microswitch for remote indication and/or can trigger a load break switch or a circuit breaker to open.

Concerning the different striker pins you'll find force-distance diagrams on page 26.

3 Temperature limiter

All SIBA 80 N striker pin systems are fitted with an integrated temperature limiter.

Consequently each SIBA striker pin has two functions:

- indication and switching function in case the fuse operates
- protection of the fuse enclosure of SF6-switchgear against inadmissible temperature rise.

SF6-insulated switchgear requires additional protection features against inadmissible temperatures of certain switchgear parts. The integrated temperature limiter avoids unacceptably high temperatures – no matter why they are generated – in gas-insulated switchgear or narrow switchgear enclosures. By means of a melting

werden die Temperaturen am Gehäuse des Sicherungseinsatzes auf maximal 100°C begrenzt. Diese Konstruktion ist besonders darauf ausgelegt, dem Endnutzer höchste Kontinuität bei der Stromversorgung zu sichern. Das System reagiert so, dass nicht jeder kurzzeitige Überstrom direkt zu einem Ansprechen der Sicherung führt. Erst wenn zulässige Grenzwerte überschritten sind, aktiviert die Sicherung den Schalter unter Einsatz des Schlagstifts.

Höhere Temperaturen an Kunststoff-Sicherungsgehäusen in SF6-isolierten Schaltanlagen können entstehen durch:

- Sicherungs-Bemessungsstrom ist für den Schutz des Transformators zu niedrig gewählt
- Sicherungen tragen Fehlerströme unterhalb des minimalen Ausschaltstroms
- Reduzierung der Stromtragfähigkeit infolge transienter Störungen z.B. Blitzeinschlag
- Fehlerströme in Transformatoren wie z.B. Windungsschluss
- zusätzliche Temperaturerhöhung aufgrund von unzureichender Kontaktierung.

Sicherungseinsätze mit integriertem Temperaturbegrenzer sind mit herkömmlichen Sicherungseinsätzen kompatibel. Es können alle Zuordnungsempfehlungen verwendet werden.

Weitere Informationen über unseren Temperaturbegrenzer und seinen Aufbau finden Sie auf unserer Website unter: www.siba.de.

4 Anwendungsempfehlungen

Empfehlungen für die Auswahl von SIBA-Sicherungen für die drei Haupteinsatzgebiete finden Sie am Ende des Kapitels zu den HHD-Sicherungen. Dort können Sie anhand von Tabellen festlegen, welche Sicherung in Frage kommt. Gleichwohl sind das nur Näherungen, die im jeweils individuellen Fall u.U. nicht weiterhelfen. In Zweifelsfällen wenden Sie sich bitte direkt an SIBA.

- Anwendungsempfehlungen für den Schutz von Netztransformatoren: Seite 15ff
- Anwendungsempfehlungen für den Schutz von Kondensatoren: Seite 20
- Anwendungshinweise für den Schutz von Motorstromkreisen: Seite 21ff

activator, temperatures inside the fuse-link enclosure are limited to below 100°C. This design especially considers continuity of current supply for the end user for as long as possible. The system reacts in such a way that short time overloads do not cause the fuse to interrupt the circuit unnecessarily. Only when inadmissible values are exceeded, the fuse will open the switch via the striker pin.

Higher temperatures on plastic fuse enclosures in SF6-insulated switchgear can be caused by:

- selection of a fuse rating too low for proper transformer protection
- fuses loaded with fault currents below the minimum breaking current
- deterioration of fuse-links caused by transient fault currents (e.g. lightning strike)
- transformer fault currents (e.g. winding short-circuit)
- additional temperature rise because of poor clip fitting.

Fuse-links with an integrated temperature limiter are compatible with standard fuse-links. All coordination schedules can be used. Additional information on our temperature limiter and its design is available on our website: www.siba-fuses.com.

4 Application recommendations

Recommendations for selecting the right SIBA fuses for the three main areas of application can be found at the end of the chapter on HHD fuses. Using the tables we have provided you can determine which fuse is right for you. Please keep in mind, though, that these are approximations only which may not fit your specific requirements in each case. If you are in doubt we recommend that you contact us.

- Application recommendations for power transformer protection: page 15ff
- Application recommendations for capacitor protection: page 20
- Application recommendations for motor circuit protection: page 21ff

3/7,2 kV "e" = 192 mm

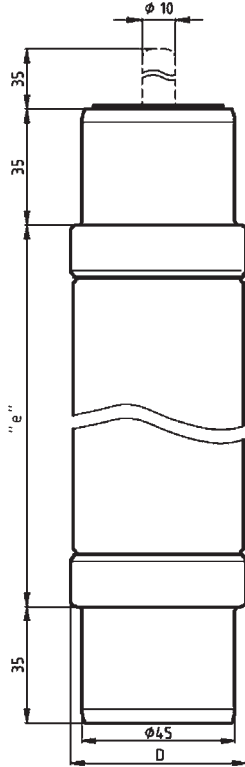

Vorzugsabmessung / Standard dimension

Einsatz / Application

Luft- und gasisolierte Mittelspannungsschaltanlagen / Air and gas insulated switchgear
Für Innen- und Freiluftanwendungen / Indoor and outdoor application

Verpackung / Packing 1 Stück / 1 piece

Betriebsklasse / Class	IEC 60282-1	VDE 0670-4
Teilbereich / Back-up	DIN 43 625	

Bemessungs- spannung Rated Voltage	Artikel Article	Bemessungsstrom Rated Current	Länge "e" Length "e"	Durchmesser D Diameter D
kV		A	mm	mm
3/7,2	30 002 13	6,3-50	192	53
	30 010 13	63-125		67
	30 018 13	160		85
	30 018 14	200RC140-250RC160		85

Bemessungs- strom Rated Current	Artikel Nr. Article No.	Gewicht Weight	Bemessungs- Ausschaltstrom Rated Breaking Current - I ₁	Minimaler Ausschaltstrom Min. Breaking Current - I ₃	Schmelzintegral Pre-Arcing I ² t-Value	Ausschaltintegral Total I ² t-Value		Leistungs- abgabe Power Loss	Kaltwider- stand Cold Resistance
						U _n min	U _n max		
A		kg/1	kA	A	A ² s	A ² s	A ² s	W	mΩ
6,3	30 002 13.6,3	1,2	63	22	45	210	360	10	178
10	30 002 13.10	1,2	63	34	75	350	560	17	113
16	30 002 13.16	1,2	63	56	250	1.100	2.000	17	50
20	30 002 13.20	1,2	63	70	640	2.900	4.800	13	27
25	30 002 13.25	1,2	63	90	1.050	4.700	7.500	16	21
31,5	30 002 13.31,5	1,2	63	110	1.700	6.600	12.000	21	17
40	30 002 13.40	1,2	63	140	2.900	12.000	19.000	27	13
50	30 002 13.50	1,2	63	170	5.700	20.000	33.000	30	9,3
63	30 010 13.63	1,5	63	210	10.700	40.000	66.000	38	6,8
80	30 010 13.80	1,5	63	280	21.000	78.000	140.000	47	4,8
100	30 010 13.100	1,5	63	320	33.000	130.000	210.000	60	3,8
125	30 010 13.125	1,5	63	390	47.000	180.000	390.000	98	3,3
160	30 018 13.160	2,9	63	600	90.000	330.000	570.000	124	2,5
200RC140	30 018 14.200	2,9	50	800	225.000	540.000	920.000	60	2,1
250RC160	30 018 14.250	2,9	50	1.000	265.000	660.000	1.100.000	70	1,9

RC = bitte Seite 13 beachten
please refer to page 13

3/7,2 kV

"e" = 192 mm



Zeit/Strom-Kennlinie
Time-current characteristic

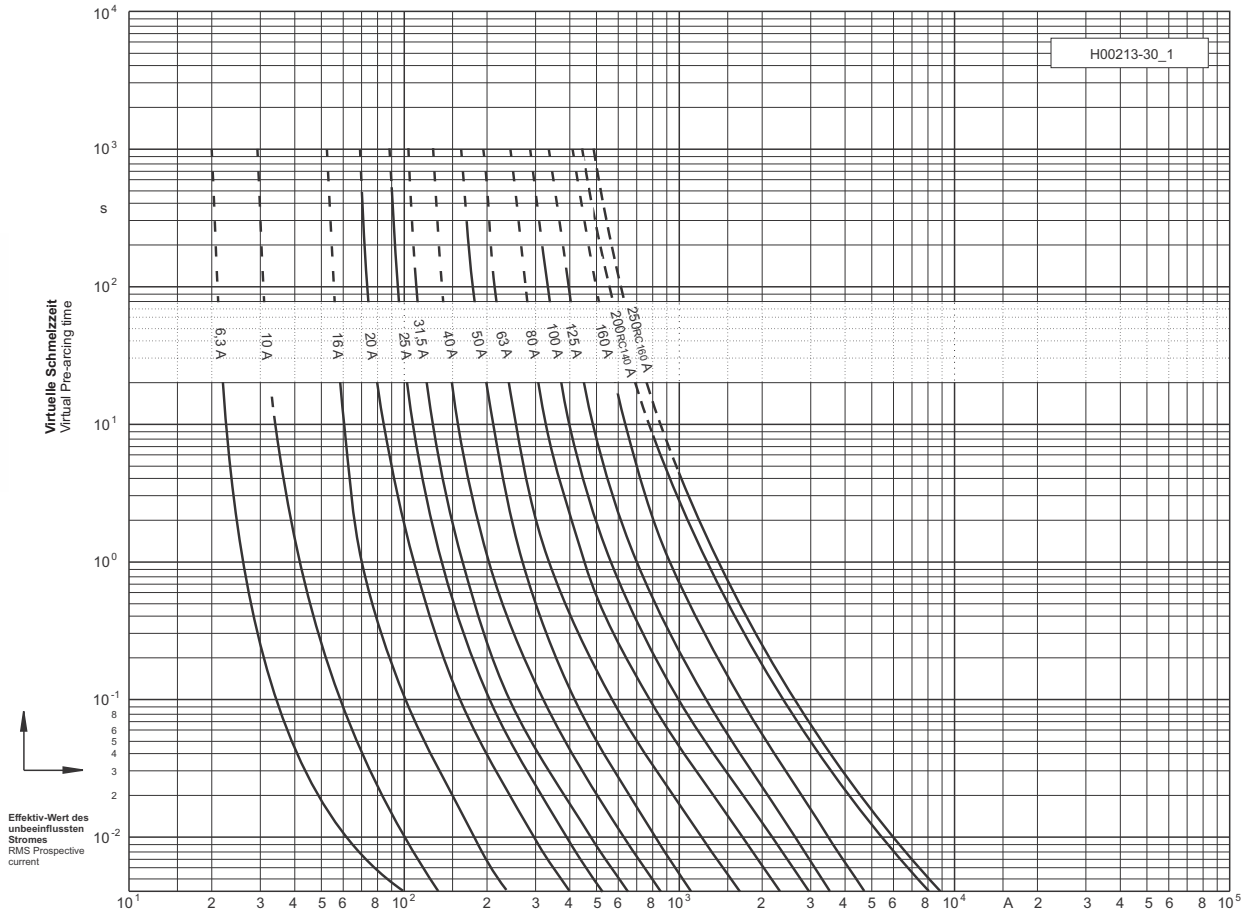

Durchlass-Strom
Cut-off current

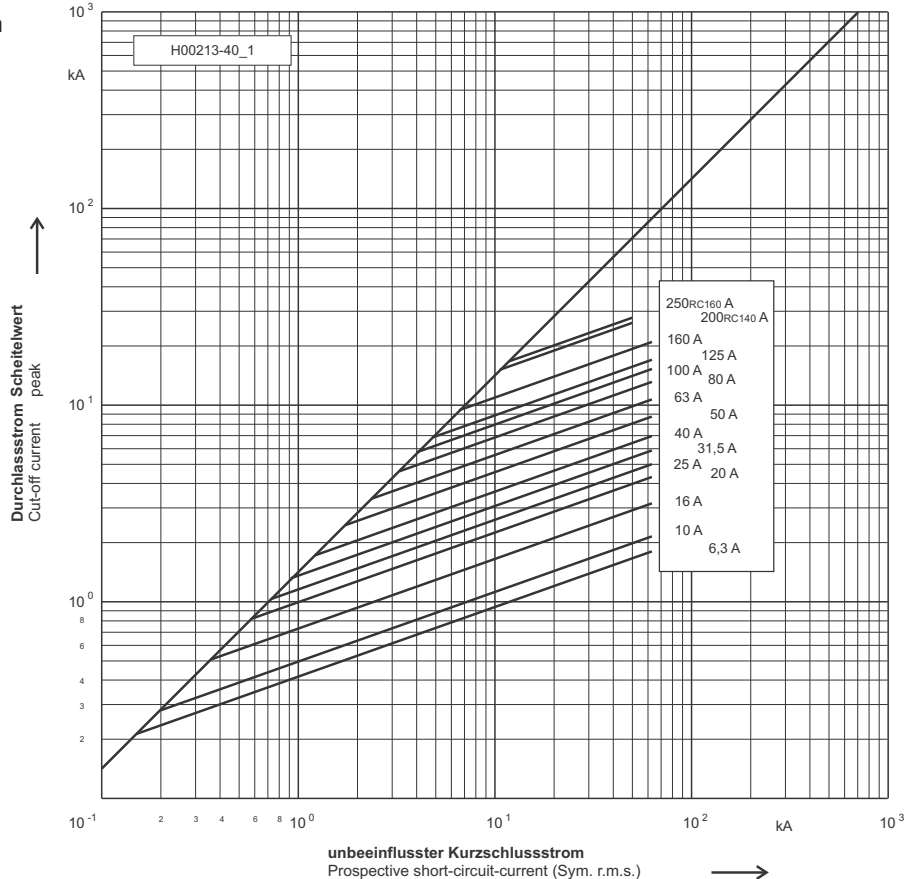

3/7,2 kV "e" = 292 mm

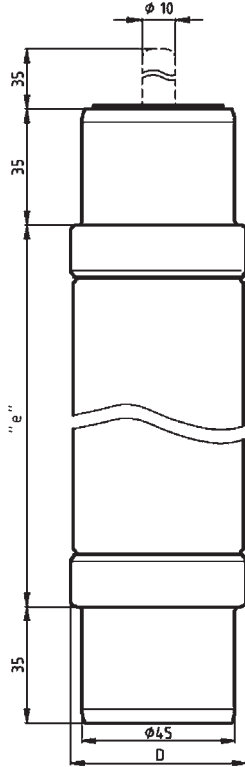

Nebenabmessung / Variant dimension

Einsatz / Application

Luft- und gasisolierte Mittelspannungsschaltanlagen / Air and gas insulated switchgear
Für Innen- und Freiluftanwendungen / Indoor and outdoor application

Verpackung / Packing 1 Stück / 1 piece

Betriebsklasse / Class	IEC 60282-1	VDE 0670-4
Teilbereich / Back-up	DIN 43 625	

Bemessungs- spannung Rated Voltage	Artikel Article	Bemessungsstrom Rated Current	Länge "e" Length "e"	Durchmesser D Diameter D
kV		A	mm	mm
3/7,2	30 098 13	6,3-50	292	53
	30 099 13	63-125		67
	30 100 13	160		85
	30 100 14	200RC160-355RC225		85

Bemessungs- strom Rated Current	Artikel Nr. Article No.	Gewicht Weight	Bemessungs- Ausschaltstrom Rated Breaking Current - I ₁	Minimaler Ausschaltstrom Min. Breaking Current - I ₃	Schmelzintegral Pre-Arcing I ² t-Value	Ausschaltintegral Total I ² t-Value		Leistungs- abgabe Power Loss	Kaltwider- stand Cold Resistance
						U _n min	U _n max		
A		kg/1	kA	A	A ² s	A ² s	A ² s	W	mΩ
6,3	30 098 13.6,3	1,6	63	22	45	210	360	10	178
10	30 098 13.10	1,6	63	34	75	350	560	17	113
16	30 098 13.16	1,6	63	56	250	1.100	2.000	17	50
20	30 098 13.20	1,6	63	70	640	2.900	4.800	13	27
25	30 098 13.25	1,6	63	90	1.050	4.700	7.500	16	21
31,5	30 098 13.31,5	1,6	63	110	1.700	6.600	12.000	21	17
40	30 098 13.40	1,6	63	140	2.900	12.000	19.000	27	13
50	30 098 13.50	1,6	63	170	5.700	20.000	33.000	30	9,3
63	30 099 13.63	2,0	63	210	10.700	40.000	66.000	34	6,8
80	30 099 13.80	2,0	63	280	21.000	78.000	140.000	47	4,8
100	30 099 13.100	2,0	63	320	33.000	130.000	210.000	58	3,8
125	30 099 13.125	2,0	63	390	47.000	180.000	390.000	98	3,3
160	30 100 13.160	3,8	63	600	90.000	330.000	570.000	103	2,5
200RC160	30 100 14.200	3,8	50	800	230.000	480.000	704.000	74	2,1
250RC180	30 100 14.250	3,8	50	1.000	371.000	750.000	1.100.000	77	1,7
315RC200	30 100 14.315	3,8	50	1.260	545.000	1.060.000	1.616.000	81	1,4
355RC225	30 100 14.355	3,8	50	1.420	825.000	1.420.000	2.225.000	89	1,2

RC = bitte Seite 13 beachten
please refer to page 13

3/7,2 kV

"e" = 292 mm



Zeit/Strom-Kennlinie
Time-current characteristic

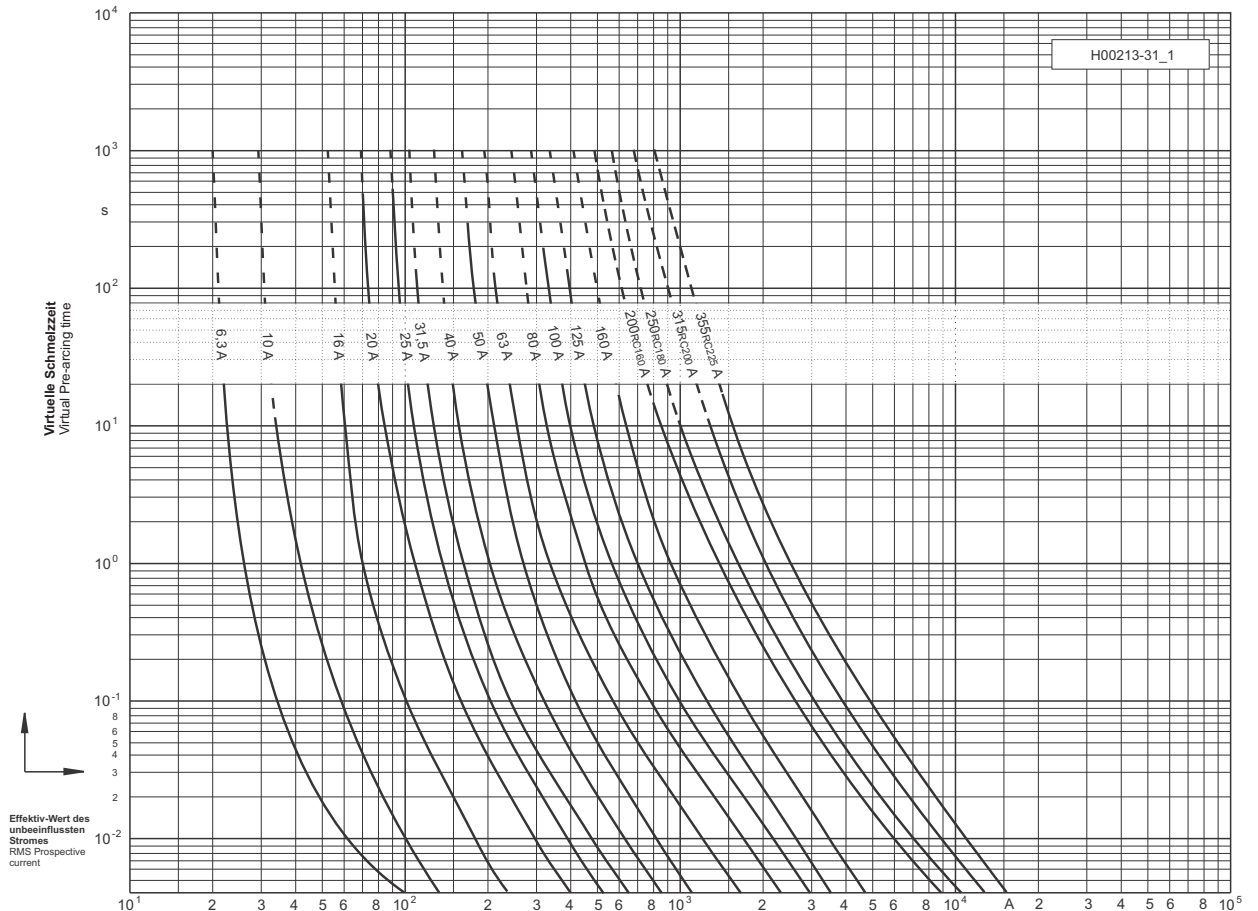

Durchlass-Strom
Cut-off current

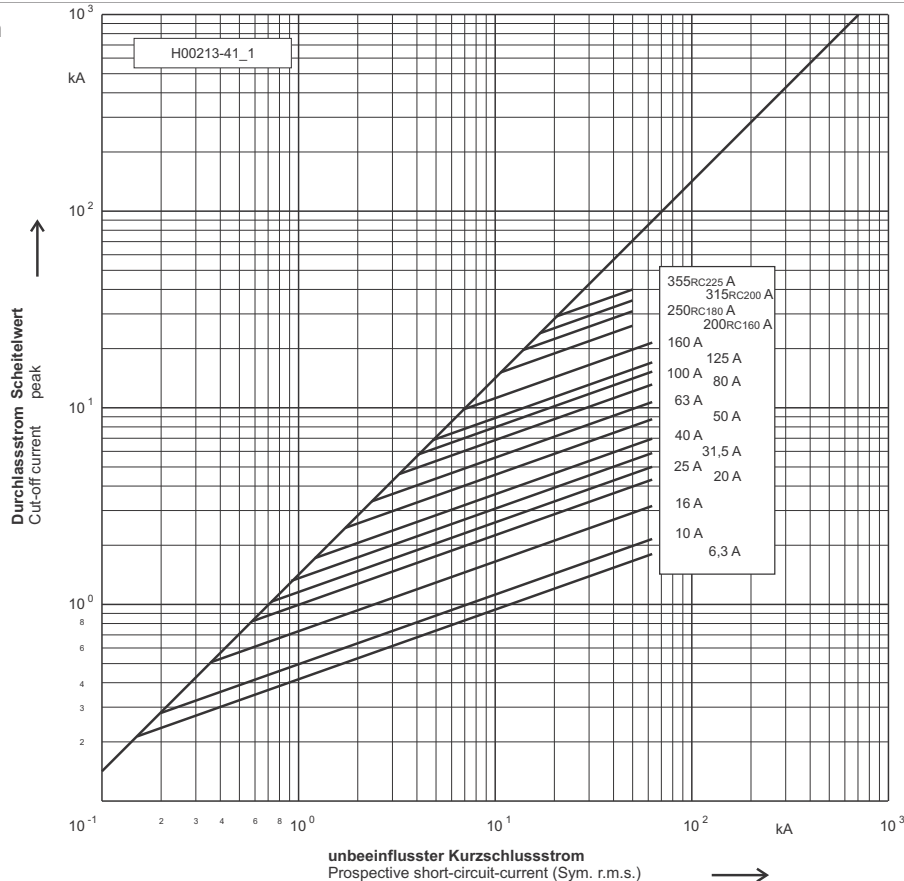

3/7,2 kV "e" = 442 mm

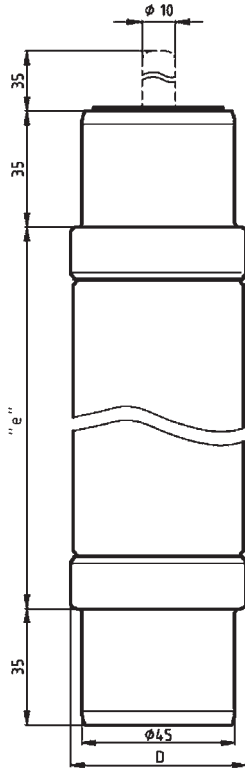
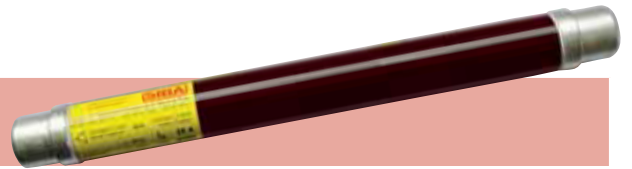

Nebenabmessung / Variant dimension

Einsatz / Application

Luft- und gasisolierte Mittelspannungsschaltanlagen / Air and gas insulated switchgear
Für Innen- und Freiluftanwendungen / Indoor and outdoor application

Verpackung / Packing 1 Stück / 1 piece

Betriebsklasse / Class	IEC 60282-1	VDE 0670-4
Teilbereich / Back-up	DIN 43 625	

Bemessungs- spannung Rated Voltage	Artikel Article	Bemessungsstrom Rated Current	Länge "e" Length "e"	Durchmesser D Diameter D
kV		A	mm	mm
3/7,2	30 108 13	6,3 - 50	442	53
	30 109 13	63 - 125		67
	30 110 13	160		85
	30 110 14	200-500 _{RC355}		85

Bemessungs- strom Rated Current	Artikel Nr. Article No.	Gewicht Weight	Bemessungs- Ausschaltstrom Rated Breaking Current - I ₁	Minimaler Ausschaltstrom Min. Breaking Current - I ₃	Schmelzintegral Pre-Arcing I ² t-Value	Ausschaltintegral Total I ² t-Value		Leistungs- abgabe Power Loss	Kaltwider- stand Cold Resistance
						U _n min	U _n max		
A		kg/1	kA	A	A ² s	A ² s	A ² s	W	mΩ
6,3	30 108 13.6,3	2,1	63	22	45	210	360	10	178
10	30 108 13.10	2,1	63	34	75	350	560	17	113
16	30 108 13.16	2,1	63	56	250	1.100	2.000	11	50
20	30 108 13.20	2,1	63	70	640	2.900	4.800	13	27
25	30 108 13.25	2,1	63	90	1.050	4.700	7.500	16	21
31,5	30 108 13.31,5	2,1	63	110	1.700	6.600	12.000	21	17
40	30 108 13.40	2,1	63	140	2.900	12.000	19.000	27	13
50	30 108 13.50	2,1	63	170	5.700	20.000	33.000	30	9,3
63	30 109 13.63	2,9	63	210	10.700	40.000	66.000	34	6,8
80	30 109 13.80	2,9	63	280	21.000	78.000	140.000	47	4,8
100	30 109 13.100	2,9	63	320	33.000	130.000	210.000	58	3,8
125	30 109 13.125	2,9	63	390	47.000	180.000	390.000	85	3,3
160	30 110 13.160	5,4	63	600	90.000	330.000	570.000	98	3,15
200	30 110 14.200	5,4	50	800	230.000	480.000	704.000	121	2,1
250 _{RC225}	30 110 14.250	5,4	50	1.000	371.000	750.000	1.100.000	145	1,7
315 _{RC250}	30 110 14.315	5,4	50	1.260	545.000	1.060.000	1.616.000	143	1,4
355 _{RC250}	30 110 14.355	5,4	50	1.420	825.000	1.420.000	2.225.000	154	1,2
400 _{RC315}	30 110 14.400	5,4	50	1.600	1.000.000	1.900.000	2.528.000	165	1,1
500 _{RC355}	30 110 14.500	5,4	50	2.000	1.668.000	3.160.000	4.500.000	176	0,85

RC = bitte Seite 13 beachten
please refer to page 13

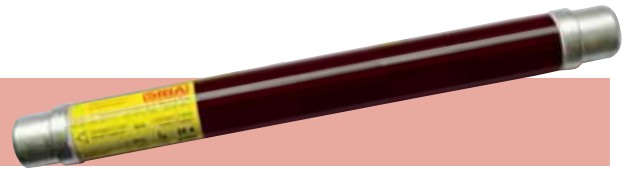

3/7,2 kV

"e" = 442 mm

Zeit/Strom-
Kennlinie
Time-current
characteristic

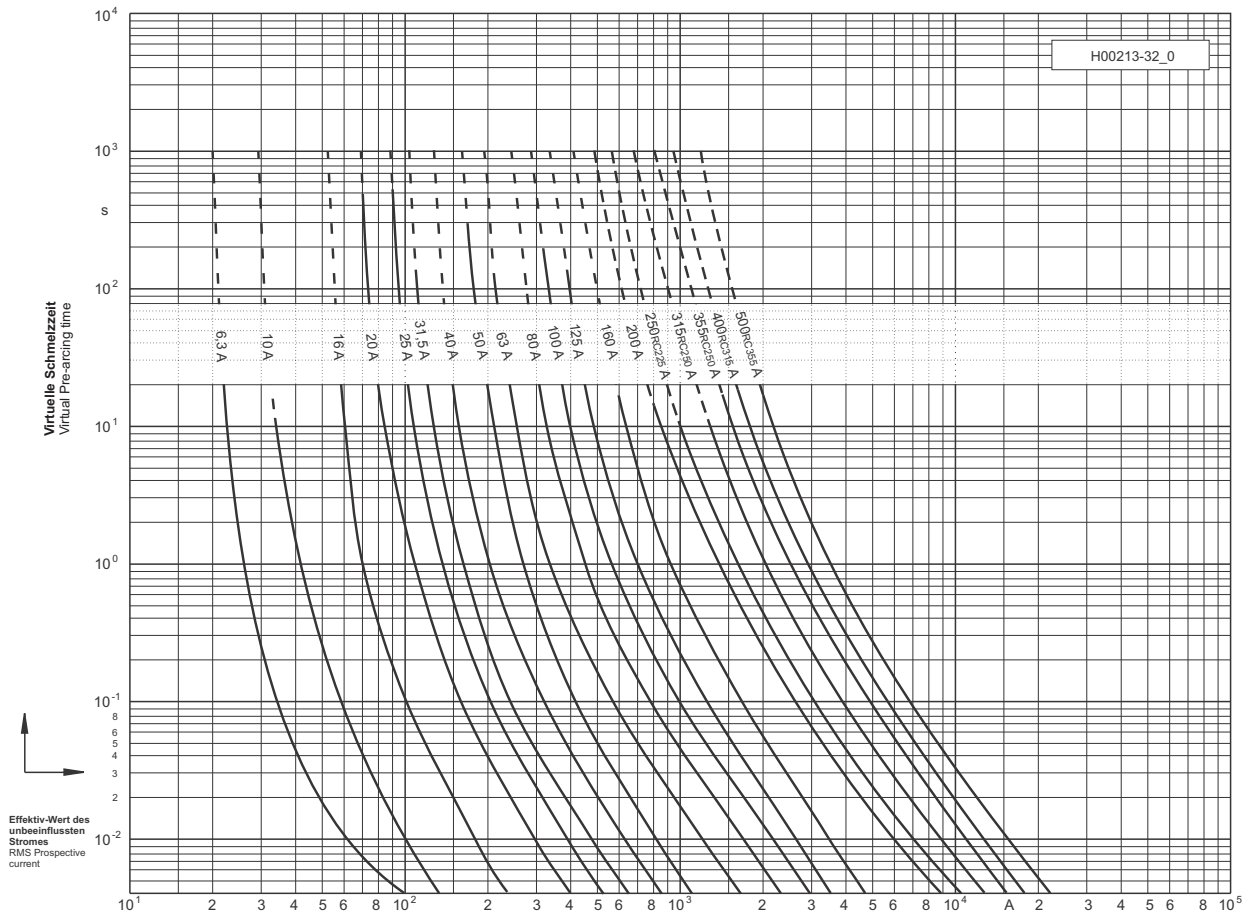

Durchlass-Strom
Cut-off current

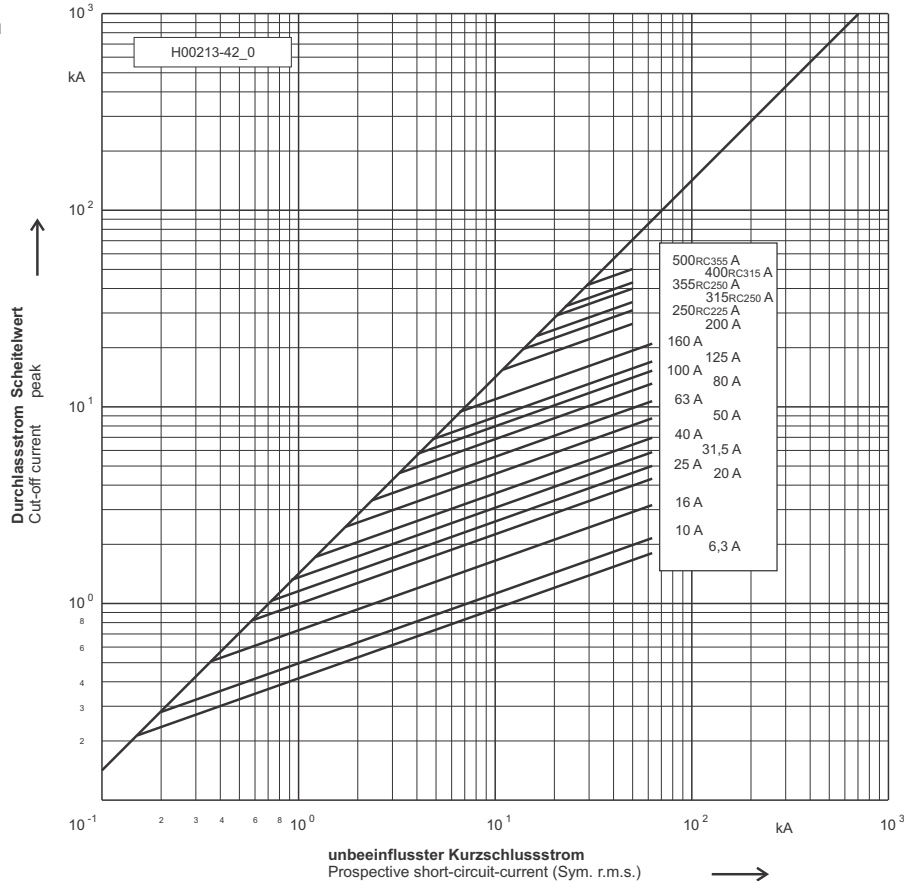

6/12 kV

"e" = 292 mm

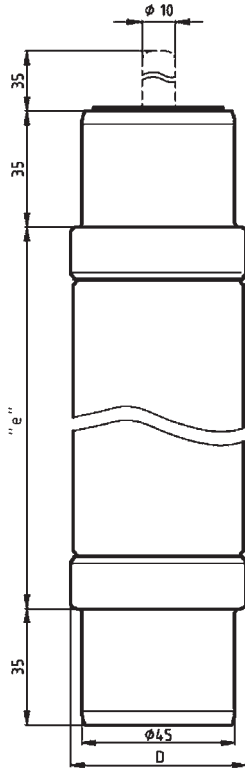

Vorzugsabmessung / Standard dimension

Einsatz / Application

Luft- und gasisolierte Mittelspannungsschaltanlagen / Air and gas insulated switchgear
Für Innen- und Freiluftanwendungen / Indoor and outdoor application

Verpackung / Packing 1 Stück / 1 piece

Betriebsklasse / Class	IEC 60282-1	VDE 0670-4
Teilbereich / Back-up	DIN 43 625	

Bemessungs- spannung Rated Voltage	Artikel Article	Bemessungsstrom Rated Current	Länge "e" Length "e"	Durchmesser D Diameter D
kV		A	mm	mm
6/12	30 004 13	6,3 - 50	292	53
	30 012 13	63 - 125		67
	30 020 13	160RC125		85
	30 020 14	200RC125 - 250RC140		85

Bemessungs- strom Rated Current	Artikel Nr. Article No.	Gewicht Weight	Bemessungs- Ausschaltstrom Rated Breaking Current - I ₁	Minimaler Ausschaltstrom Min. Breaking Current - I ₃	Schmelzintegral Pre-Arcing I ² t-Value	Ausschaltintegral Total I ² t-Value		Leistungs- abgabe Power Loss	Kaltwider- stand Cold Resistance
						U _n min	U _n max		
A		kg/1	kA	A	A ² s	A ² s	A ² s	W	mΩ
6,3	30 004 13.6,3	1,6	63	22	45	210	360	16	297
10	30 004 13.10	1,6	63	34	75	350	560	28	189
16	30 004 13.16	1,6	63	56	250	1.100	2.000	28	84
20	30 004 13.20	1,6	63	70	640	2.900	4.800	23	45
25	30 004 13.25	1,6	63	90	1.050	4.700	7.500	29	34
31,5	30 004 13.31,5	1,6	63	110	1.700	6.600	12.000	38	28
40	30 004 13.40	1,6	63	140	2.900	12.000	19.000	50	22
50	30 004 13.50	1,6	63	170	5.700	20.000	33.000	56	16
63	30 012 13.63	2,0	63	210	10.700	40.000	66.000	63	12
80	30 012 13.80	2,0	63	280	21.000	64.000	140.000	76	8,5
100	30 012 13.100	2,0	63	320	28.000	97.000	210.000	104	6,5
125	30 012 13.125	2,0	63	390	38.000	138.000	300.000	159	5,5
160RC125	30 020 13.160	3,8	63	600	78.000	350.000	615.000	96	4,2
200RC125	30 020 14.200	3,8	50	800	227.000	465.000	800.000	91	3,6
250RC140	30 020 14.250	3,8	50	1.000	265.000	540.000	930.000	92	3,2

RC = bitte Seite 13 beachten
please refer to page 13

6/12 kV

"e" = 292 mm



Zeit/Strom-Kennlinie
Time-current characteristic

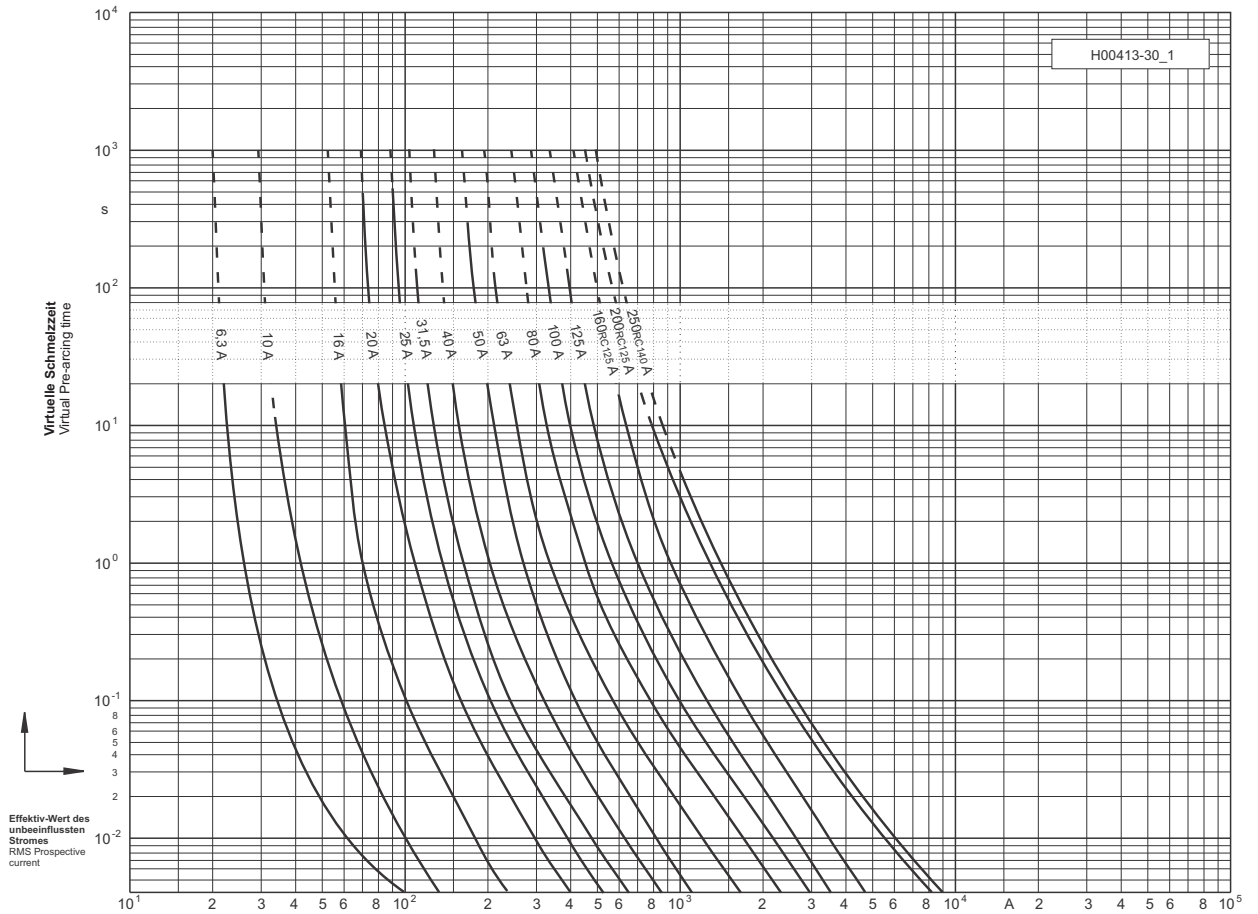

Durchlass-Strom
Cut-off current

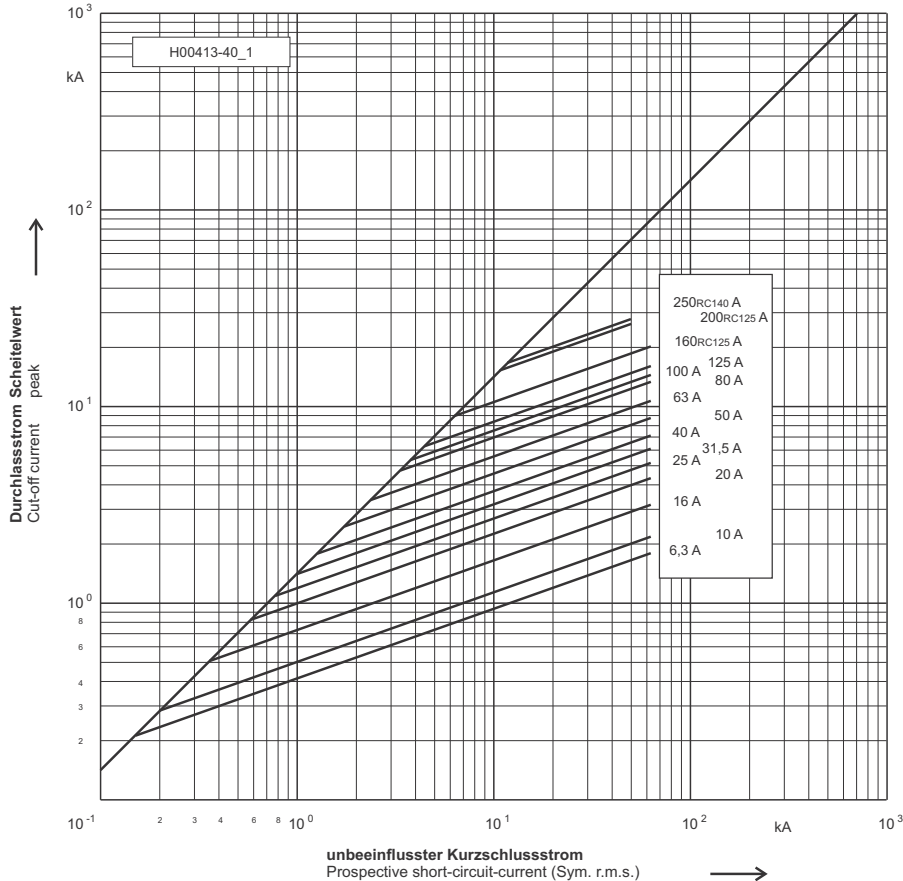

6/12 kV

"e" = 192 mm

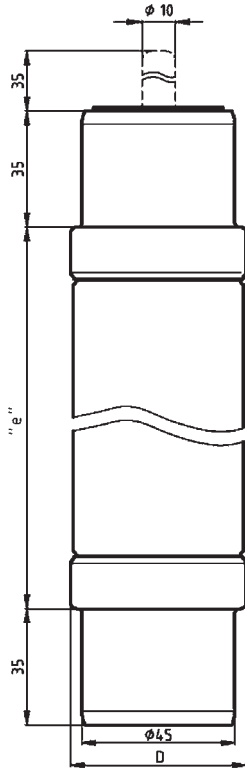

Nebenabmessung / Variant dimension

Einsatz / Application

Luft- und gasisolierte Mittelspannungsschaltanlagen / Air and gas insulated switchgear
Für Innen- und Freiluftanwendungen / Indoor and outdoor application

Verpackung / Packing 1 Stück / 1 piece

Betriebsklasse / Class
Teilbereich / Back-up

IEC 60282-1
DIN 43 625

VDE 0670-4

Bemessungs- spannung Rated Voltage	Artikel Article	Bemessungsstrom Rated Current	Länge "e" Length "e"	Durchmesser D Diameter D
kV		A	mm	mm
6/12	30 119 13	6,3 - 16	192	53
	30 267 13	20 - 63		67

Bemessungs- strom Rated Current	Artikel Nr. Article No.	Gewicht Weight	Bemessungs- Ausschaltstrom Rated Breaking Current - I_1	Minimaler Ausschaltstrom Min. Breaking Current - I_3	Schmelzintegral Pre-Arcing I^2t -Value	Ausschaltintegral Total I^2t -Value		Leistungs- abgabe Power Loss	Kaltwider- stand Cold Resistance
						U_n min	U_n max		
A		kg/1	kA	A	A^2s	A^2s	A^2s	W	m Ω
6,3	30 119 13.6,3	1,2	63	22	45	210	360	16	297
10	30 119 13.10	1,2	63	34	75	350	560	28	189
16	30 119 13.16	1,2	63	56	250	1.100	2.000	28	87
20	30 267 13.20	1,5	63	70	640	2.900	4.800	23	46
25	30 267 13.25	1,5	63	90	1.050	4.700	7.500	29	36
31,5	30 267 13.31,5	1,5	63	110	1.700	6.600	12.000	38	29
40	30 267 13.40	1,5	63	140	2.900	12.000	19.000	50	22
50	30 267 13.50	1,5	63	170	5.700	20.000	33.000	56	16
63	30 267 13.63	1,5	63	210	10.700	40.000	66.000	63	12

6/12 kV

"e" = 192 mm



Zeit/Strom-Kennlinie
Time-current characteristic

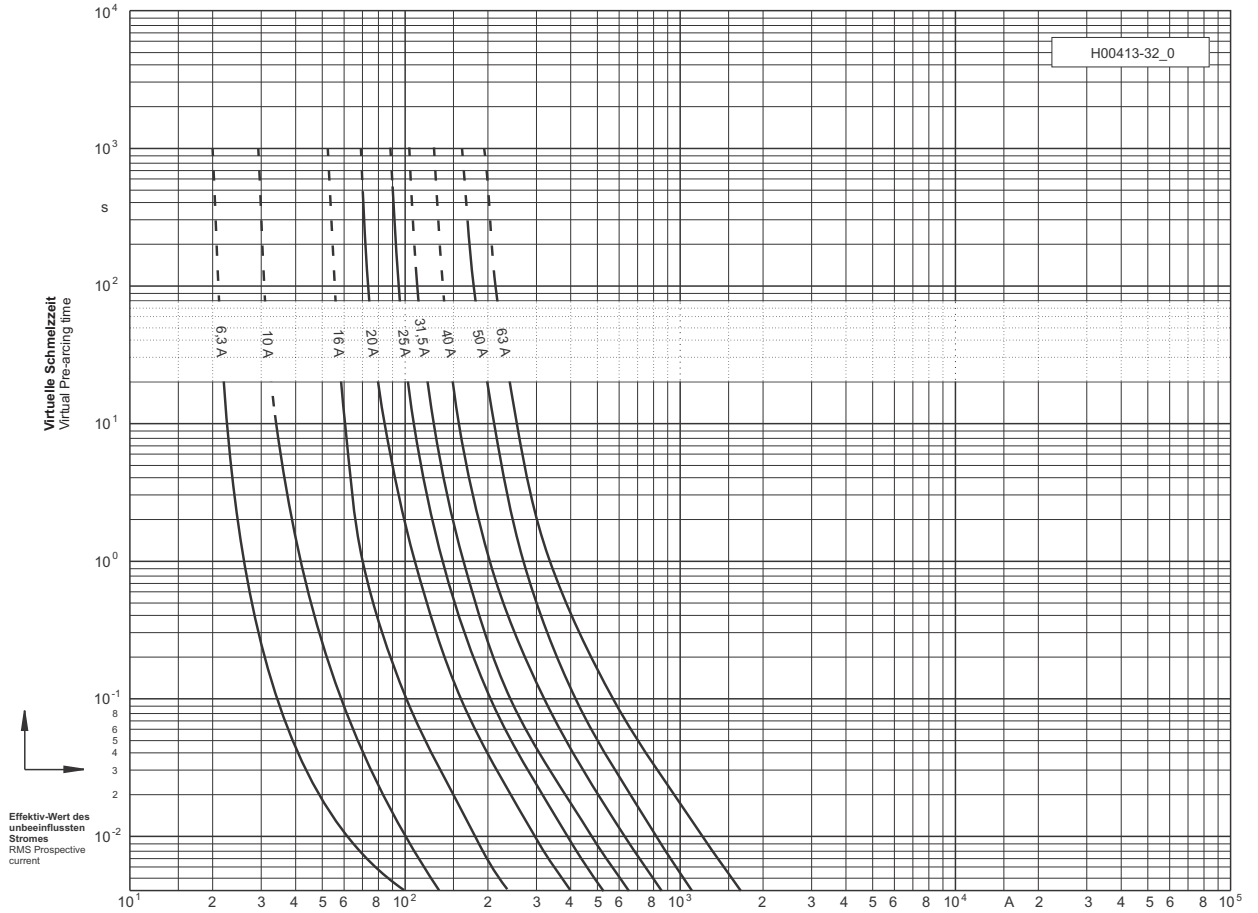

Durchlass-Strom
Cut-off current

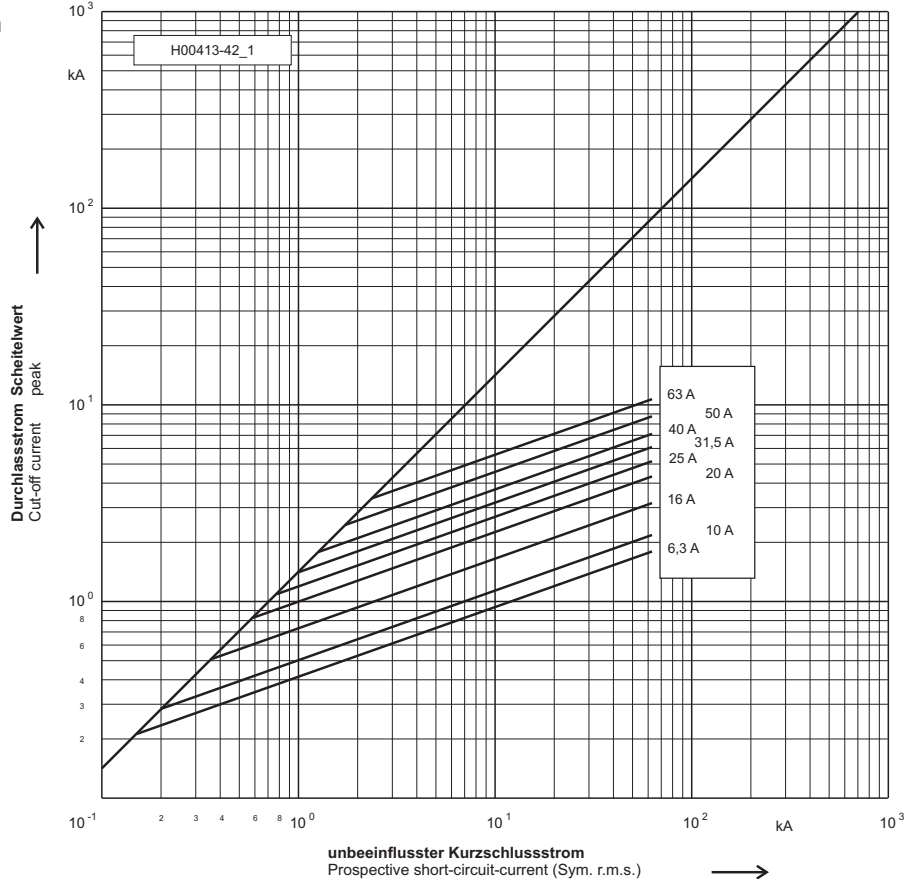

6/12 kV

"e" = 442 mm

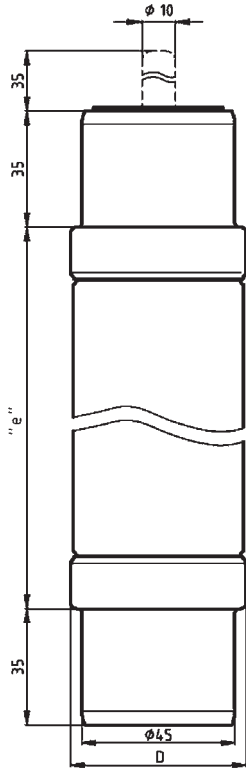
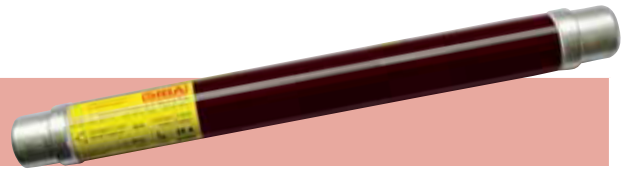

Nebenabmessung / Variant dimension

Einsatz / Application

Luft- und gasisolierte Mittelspannungsschaltanlagen / Air and gas insulated switchgear
Für Innen- und Freiluftanwendungen / Indoor and outdoor application

Verpackung / Packing 1 Stück / 1 piece

Betriebsklasse / Class	IEC 60282-1	VDE 0670-4
Teilbereich / Back-up	DIN 43 625	

Bemessungs- spannung Rated Voltage	Artikel Article	Bemessungsstrom Rated Current	Länge "e" Length "e"	Durchmesser D Diameter D
kV		A	mm	mm
6/12	30 101 13	6,3 - 50	442	53
	30 102 13	63 - 125		67
	30 103 13	160		85
	30 103 14	200RC180 - 250RC200		85

Bemessungs- strom Rated Current	Artikel Nr. Article No.	Gewicht Weight	Bemessungs- Ausschaltstrom Rated Breaking Current - I ₁	Minimaler Ausschaltstrom Min. Breaking Current - I ₃	Schmelzintegral Pre-Arcing I ₂ t-Value	Ausschaltintegral Total I ² t-Value		Leistungs- abgabe Power Loss	Kaltwider- stand Cold Resistance
						U _n min	U _n max		
A		kg/1	kA	A	A ² s	A ² s	A ² s	W	mΩ
6,3	30 101 13.6,3	2,2	63	22	45	210	360	16	297
10	30 101 13.10	2,2	63	34	75	350	560	28	189
16	30 101 13.16	2,2	63	56	250	1.100	2.000	19	87
20	30 101 13.20	2,2	63	70	640	2.900	4.800	22	46
25	30 101 13.25	2,2	63	90	1.050	4.700	7.500	28	36
31,5	30 101 13.31,5	2,2	63	110	1.700	6.600	12.000	37	29
40	30 101 13.40	2,2	63	140	2.900	12.000	19.000	48	22
50	30 101 13.50	2,2	63	170	5.700	20.000	33.000	54	16
63	30 102 13.63	2,9	63	210	10.700	40.000	66.000	58	12
80	30 102 13.80	2,9	63	280	21.000	64.000	140.000	70	8,5
100	30 102 13.100	2,9	63	320	28.000	97.000	210.000	96	6,5
125	30 102 13.125	2,9	63	390	38.000	133.000	300.000	127	5,5
160	30 103 13.160	5,4	63	600	78.000	350.000	615.000	172	4,1
200RC180	30 103 14.200	5,4	50	800	310.000	630.000	1.200.000	134	3,0
250RC200	30 103 14.250	5,4	50	1.000	405.000	850.000	1.500.000	139	2,6

RC = bitte Seite 13 beachten
please refer to page 13

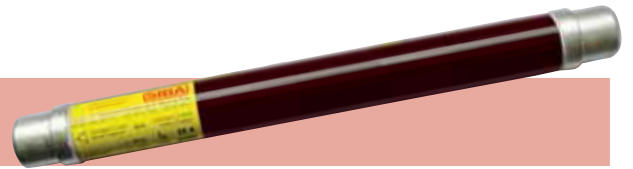

6/12 kV

"e" = 442 mm

Zeit/Strom-
Kennlinie
Time-current
characteristic

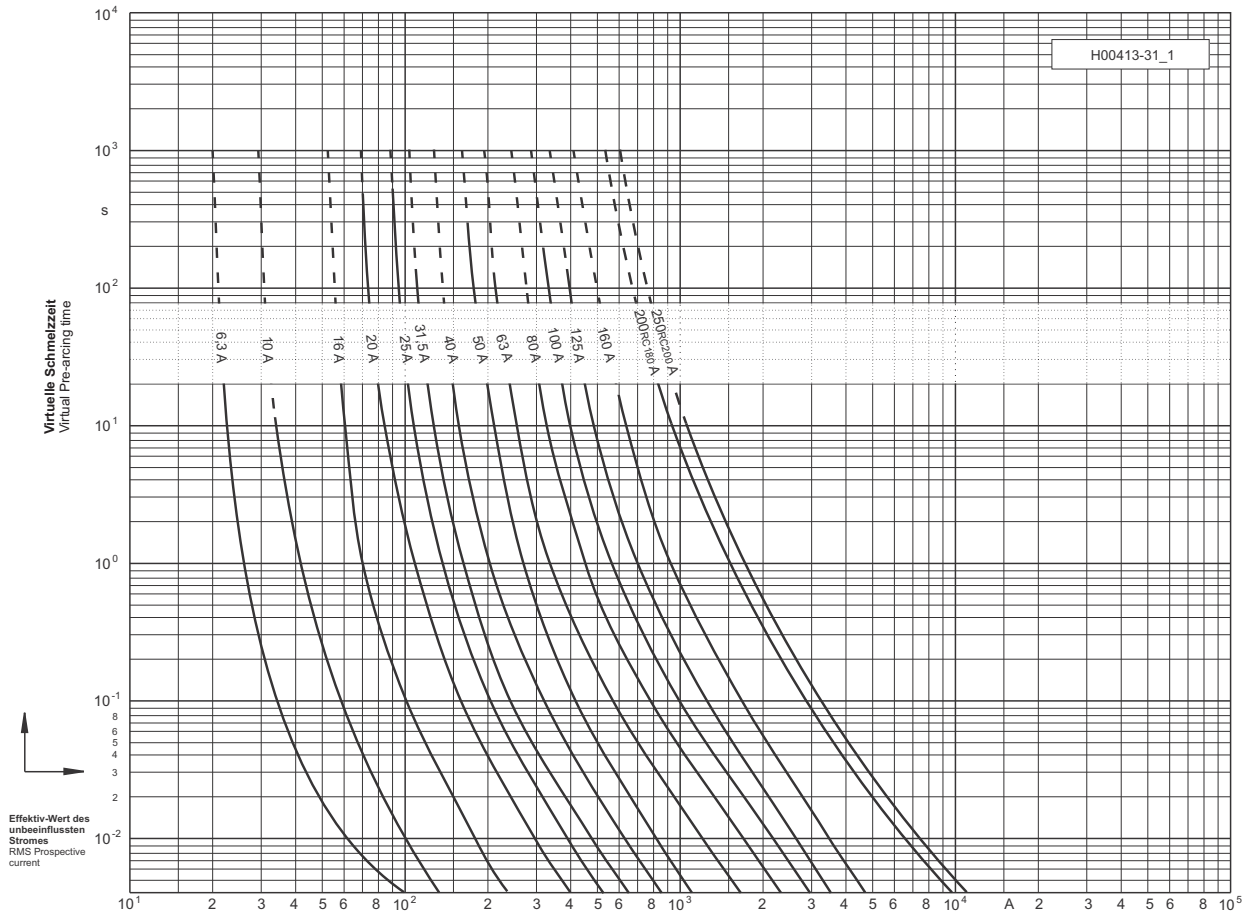

Durchlass-Strom
Cut-off current

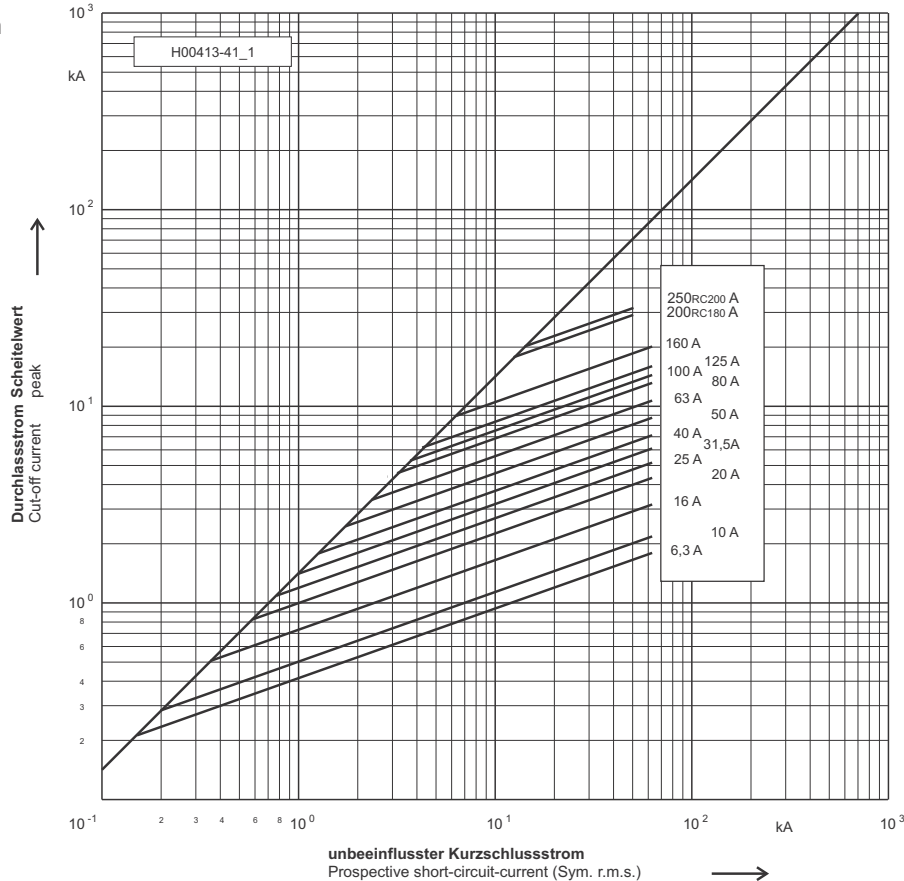

6/12 kV

"e" = 537 mm

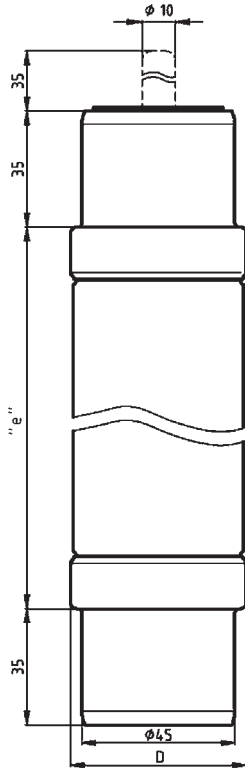
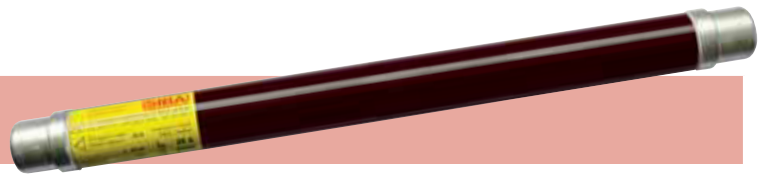

Nebenabmessung / Variant dimension

Einsatz / Application

Luft- und gasisolierte Mittelspannungsschaltanlagen / Air and gas insulated switchgear
Für Innen- und Freiluftanwendungen / Indoor and outdoor application

Verpackung / Packing 1 Stück / 1 piece

Betriebsklasse / Class	IEC 60282-1	VDE 0670-4
Teilbereich / Back-up	DIN 43 625	

Bemessungs- spannung Rated Voltage	Artikel Article	Bemessungsstrom Rated Current	Länge "e" Length "e"	Durchmesser D Diameter D
kV		A	mm	mm
6/12	30 211 13	100 - 160	537	85
	30 211 14	200RC180 - 315RC225		85

Bemessungs- strom Rated Current	Artikel Nr. Article No.	Gewicht Weight	Bemessungs- Ausschaltstrom Rated Breaking Current - I ₁	Minimaler Ausschaltstrom Min. Breaking Current - I ₃	Schmelzintegral Pre-Arcing I ² t-Value	Ausschaltintegral Total I ² t-Value		Leistungs- abgabe Power Loss	Kaltwider- stand Cold Resistance
						U _n min	U _n max		
A		kg/1	kA	A	A ² s	A ² s	A ² s	W	mΩ
100	30 211 13.100	6,8	63	320	33.000	130.000	210.000	96	6,5
125	30 211 13.125	6,8	63	390	47.000	180.000	390.000	147	5,5
160	30 211 13.160	6,8	63	600	78.000	350.000	615.000	172	3,9
200RC180	30 211 14.200	6,8	50	800	310.000	630.000	1.200.000	163	3,0
250RC212	30 211 14.250	6,8	50	1.000	405.000	850.000	1.500.000	185	2,6
315RC225	30 211 14.315	6,8	50	1.260	580.000	1.100.000	2.000.000	187	2,2

RC = bitte Seite 13 beachten
please refer to page 13

6/12 kV

"e" = 537 mm



Zeit/Strom-Kennlinie
Time-current characteristic

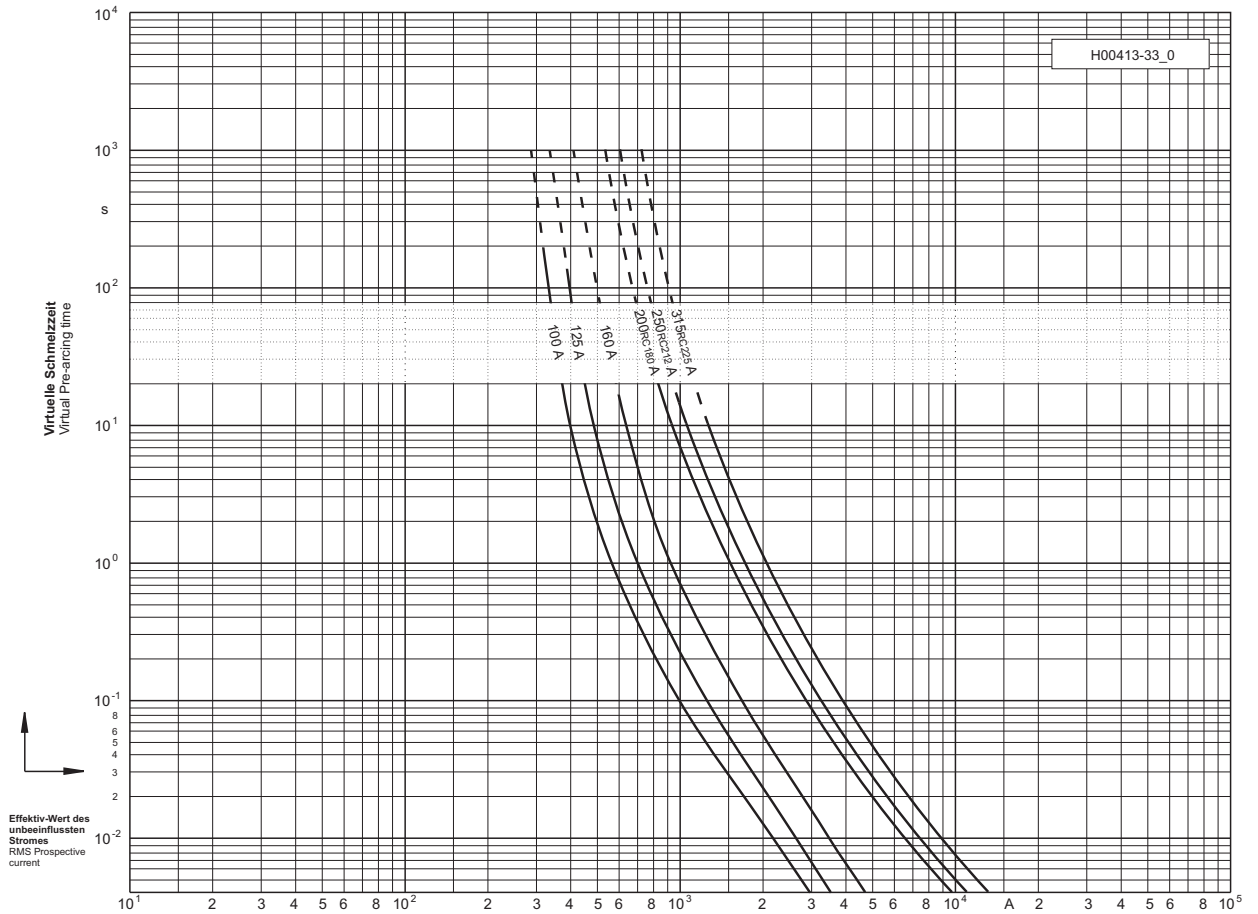

Durchlass-Strom
Cut-off current

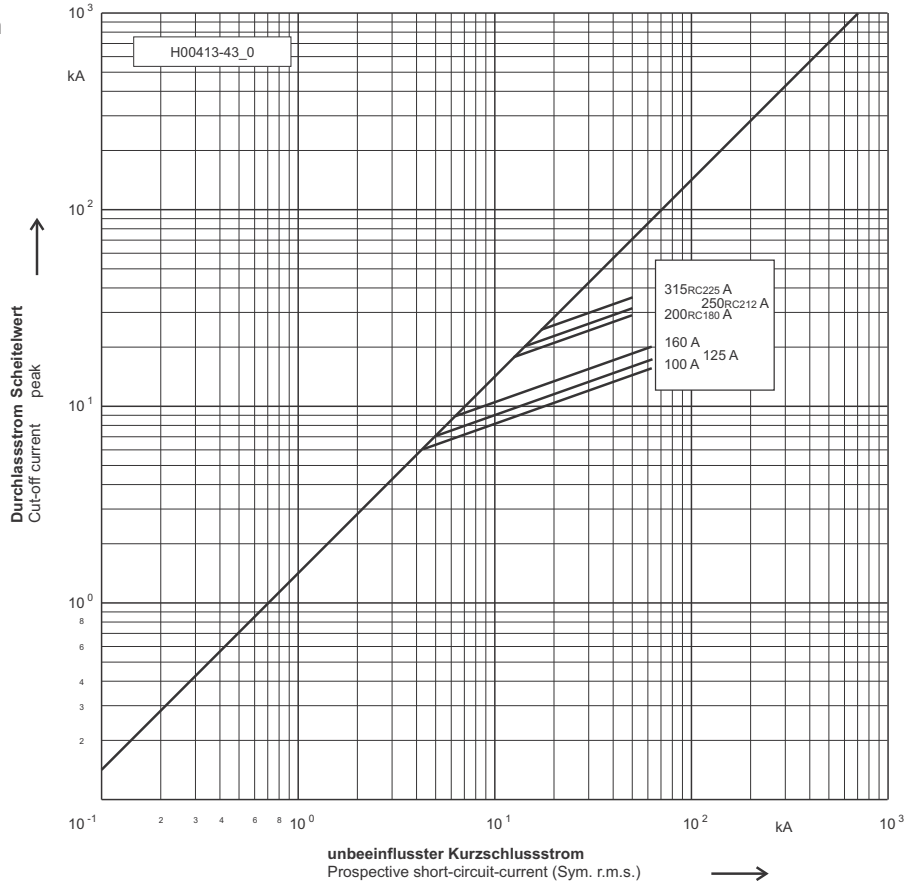

10/17,5 kV "e" = 367 mm

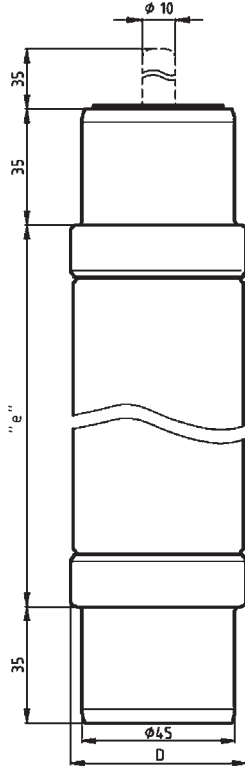

Vorzugsabmessung / Standard dimension

Einsatz / Application

Luft- und gasisolierte Mittelspannungsschaltanlagen / Air and gas insulated switchgear
Für Innen- und Freiluftanwendungen / Indoor and outdoor application

Verpackung / Packing 1 Stück / 1 piece

Betriebsklasse / Class	IEC 60282-1	VDE 0670-4
Teilbereich / Back-up	DIN 43 625	

Bemessungs- spannung Rated Voltage	Artikel Article	Bemessungsstrom Rated Current	Länge "e" Length "e"	Durchmesser D Diameter D
kV		A	mm	mm
10/17,5	30 176 13	6,3 - 25	367	53
	30 177 13	31,5 - 63		67
	30 178 13	80 - 160 _{RC112}		85
	30 178 14	200 _{RC125}		85

Bemessungs- strom Rated Current	Artikel Nr. Article No.	Gewicht Weight	Bemessungs- Ausschaltstrom Rated Breaking Current - I ₁	Minimaler Ausschaltstrom Min. Breaking Current - I ₃	Schmelzintegral Pre-Arcing I ² t-Value	Ausschaltintegral Total I ² t-Value		Leistungs- abgabe Power Loss	Kaltwider- stand Cold Resistance
						U _n min	U _n max		
A		kg/1	kA	A	A ² s	A ² s	A ² s	W	mΩ
6,3	30 176 13.6,3	2,0	63	22	45	210	360	21	397
10	30 176 13.10	2,0	63	34	75	350	560	38	252
16	30 176 13.16	2,0	63	56	250	1.100	2.000	37	116
20	30 176 13.20	2,0	63	70	640	2.900	4.800	40	62
25	30 176 13.25	2,0	63	90	1.050	4.700	7.500	56	48
31,5	30 177 13.31,5	3,0	63	110	1.700	6.600	12.000	65	39
40	30 177 13.40	3,0	63	140	2.900	12.000	19.000	84	29
50	30 177 13.50	3,0	63	170	5.700	20.000	33.000	101	21
63	30 177 13.63	3,0	63	210	10.700	40.000	66.000	106	16
80	30 178 13.80	4,8	63	280	17.500	74.000	135.000	137	11
100	30 178 13.100	4,8	63	320	28.000	134.000	215.000	157	8,5
125	30 178 13.125	4,8	63	390	47.000	225.000	360.000	190	6,6
160 _{RC112}	30 178 13.160	4,8	63	600	62.000	290.000	475.000	116	6,4
200 _{RC125}	30 178 14.200	4,8	63	800	78.000	360.000	595.000	118	5,2

RC = bitte Seite 13 beachten
please refer to page 13

10/17,5 kV "e" = 367 mm



Zeit/Strom-Kennlinie
Time-current characteristic

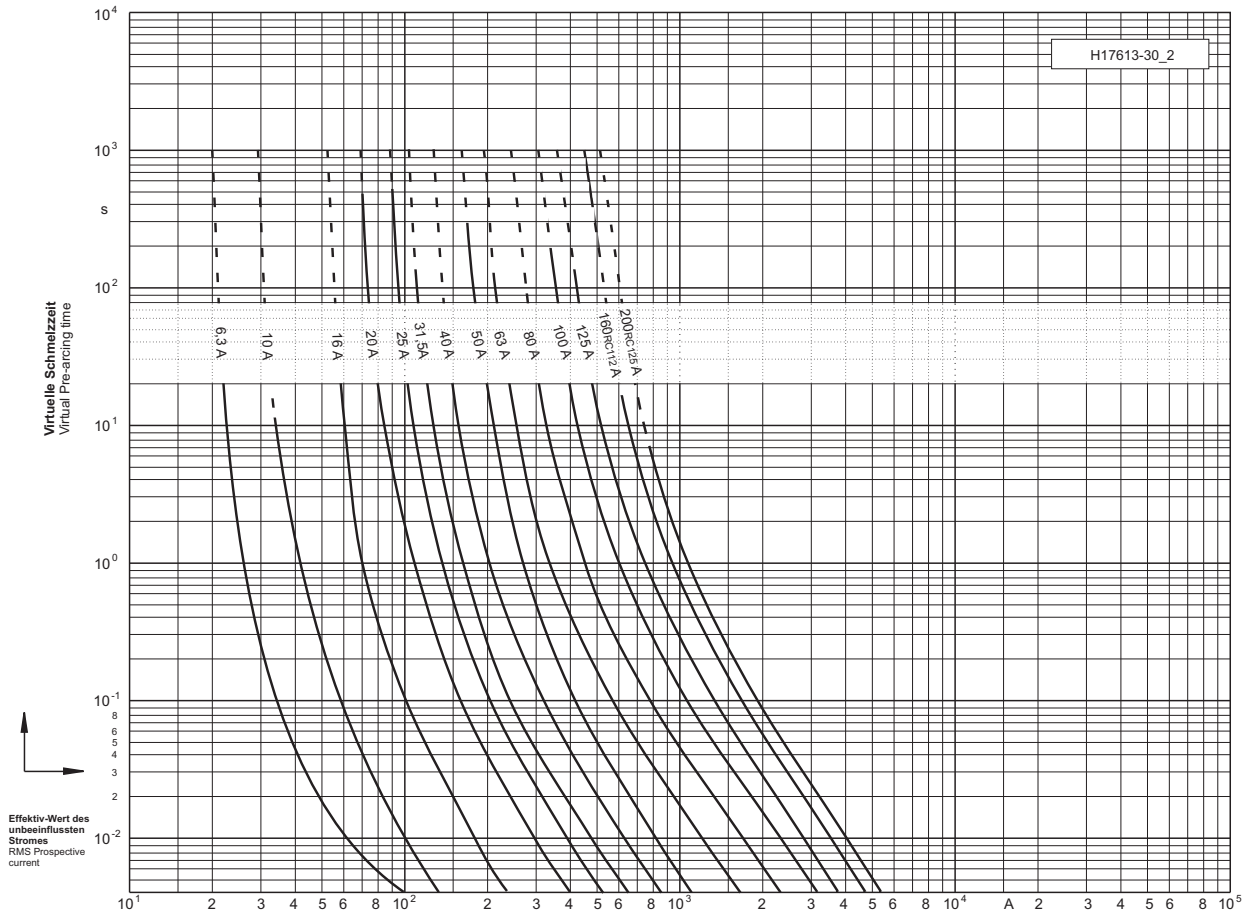

Durchlass-Strom
Cut-off current

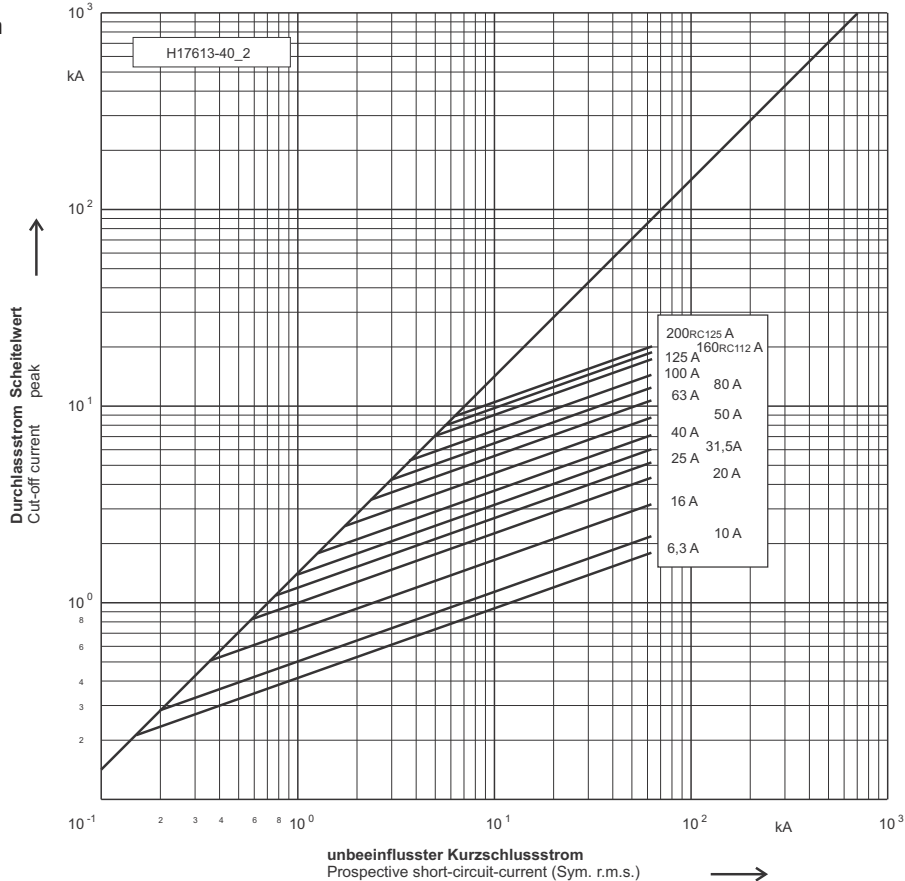

10/17,5 kV "e" = 292 mm

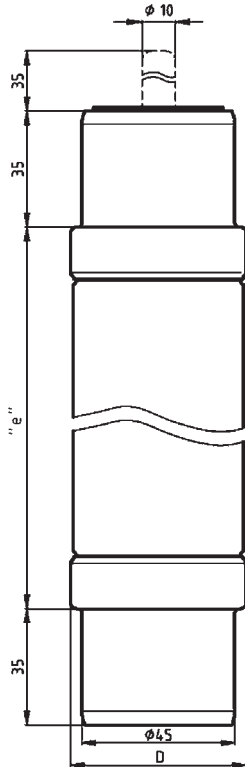

Nebenabmessung / Variant dimension

Einsatz / Application

Luft- und gasisolierte Mittelspannungsschaltanlagen / Air and gas insulated switchgear
Für Innen- und Freiluftanwendungen / Indoor and outdoor application

Verpackung / Packing 1 Stück / 1 piece

Betriebsklasse / Class	IEC 60282-1	VDE 0670-4
Teilbereich / Back-up	DIN 43 625	

Bemessungs- spannung Rated Voltage	Artikel Article	Bemessungsstrom Rated Current	Länge "e" Length "e"	Durchmesser D Diameter D
kV		A	mm	mm
10/17,5	30 255 13	6,3 - 16	292	53
	30 221 13	20 - 63		67
	30 222 13	80 - 160RC100		85

Bemessungs- strom Rated Current	Artikel Nr. Article No.	Gewicht Weight	Bemessungs- Ausschaltstrom Rated Breaking Current - I ₁	Minimaler Ausschaltstrom Min. Breaking Current - I ₃	Schmelzintegral Pre-Arcing I ² t-Value	Ausschaltintegral Total I ² t-Value		Leistungs- abgabe Power Loss	Kaltwider- stand Cold Resistance
						U _n min	U _n max		
A		kg/1	kA	A	A ² s	A ² s	A ² s	W	mΩ
6,3	30 255 13.6,3	1,6	63	22	45	210	360	21	397
10	30 255 13.10	1,6	63	34	75	350	560	38	252
16	30 255 13.16	1,6	63	56	250	1.100	2.000	37	116
20	30 221 13.20	2,0	63	70	640	2.900	4.800	40	62
25	30 221 13.25	2,0	63	90	1.050	4.700	7.500	56	48
31,5	30 221 13.31,5	2,0	63	110	1.700	6.600	12.000	65	39
40	30 221 13.40	2,0	63	140	2.900	12.000	19.000	84	29
50	30 221 13.50	2,0	63	170	5.700	20.000	33.000	101	21
63	30 221 13.63	2,0	63	210	10.700	40.000	66.000	106	16
80	30 222 13.80	3,8	63	280	17.500	74.000	155.000	137	11
100	30 222 13.100	3,8	63	320	28.000	120.000	250.000	165	8,5
125	30 222 13.125	3,8	63	390	38.000	160.000	337.000	235	7,3
160RC100	30 222 13.160	3,8	63	600	42.000	173.000	375.000	96	6,6

RC = bitte Seite 13 beachten
please refer to page 13

10/17,5 kV "e" = 292 mm



**Zeit/Strom-
Kennlinie**
Time-current
characteristic

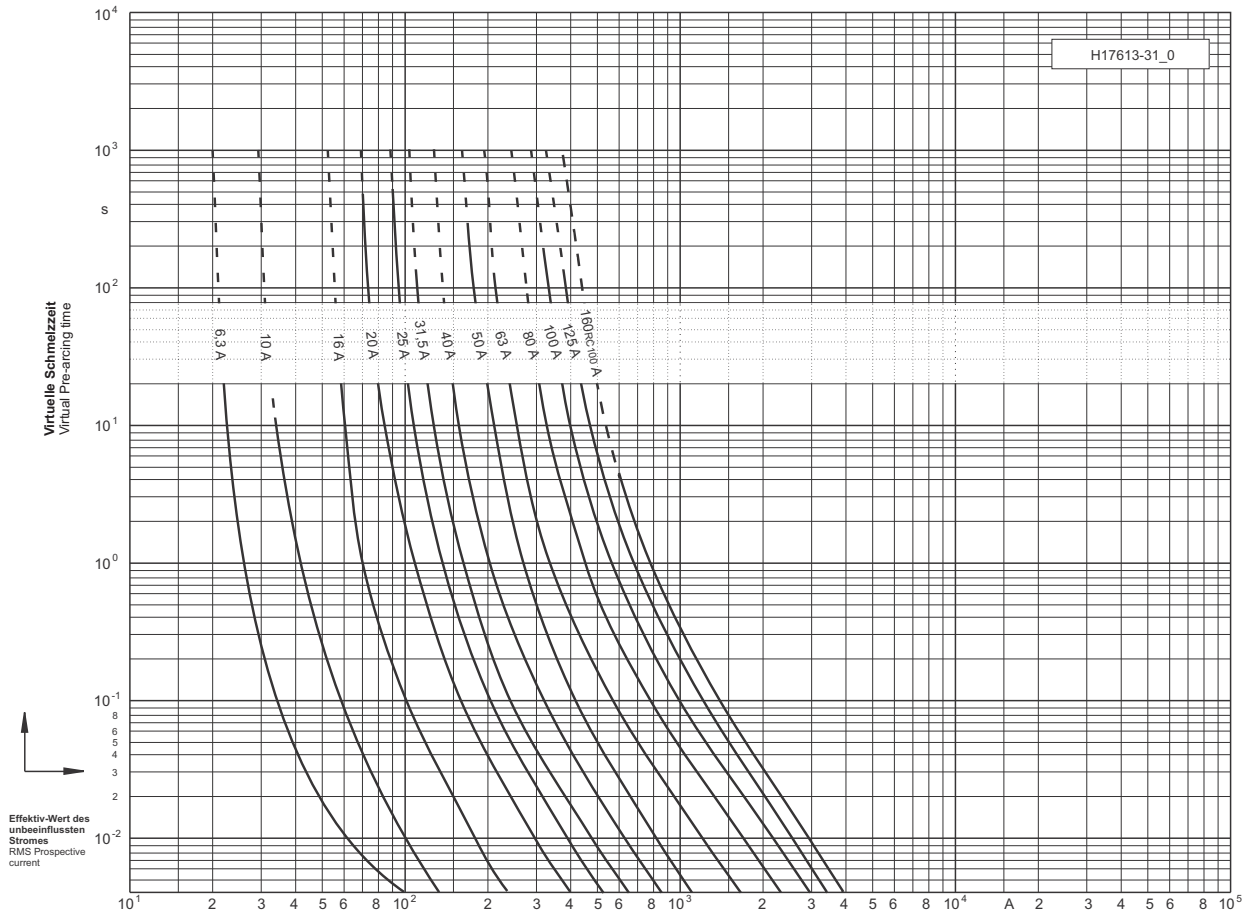

Durchlass-Strom
Cut-off current

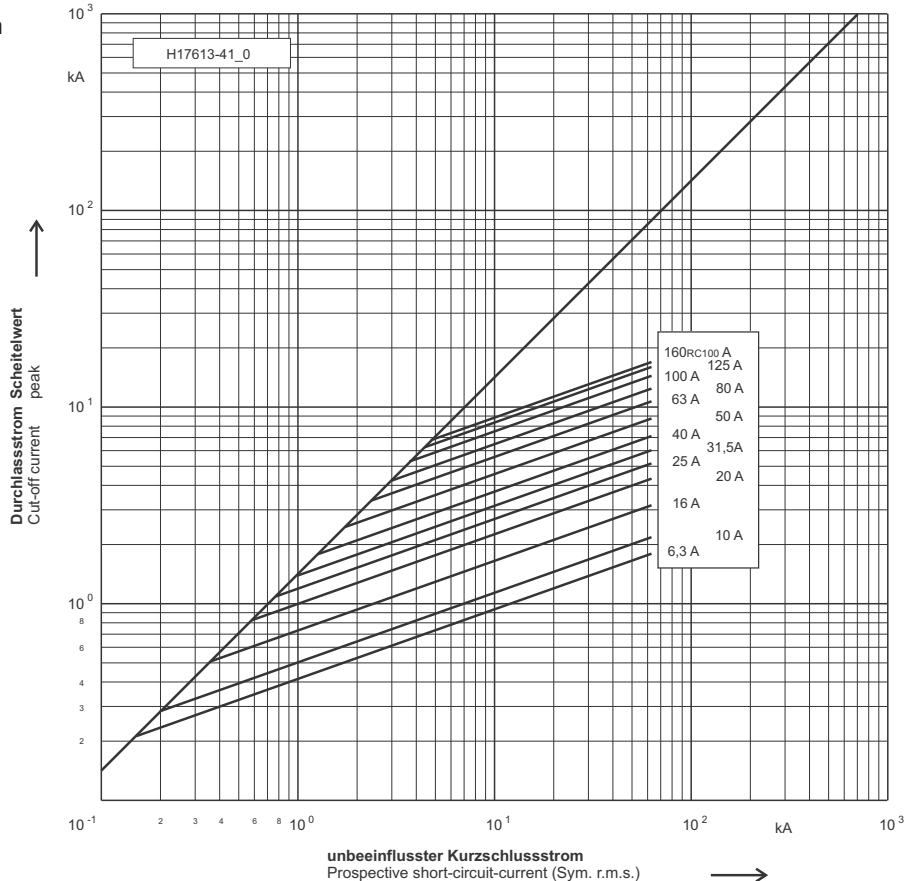

unbeeinflusster Kurzschlussstrom
Prospective short-circuit-current (Sym. r.m.s.) →

10/17,5 kV "e" = 442 mm

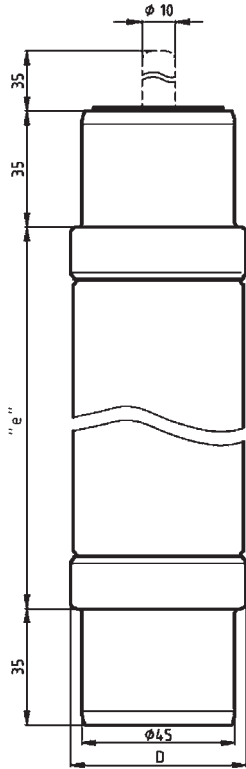
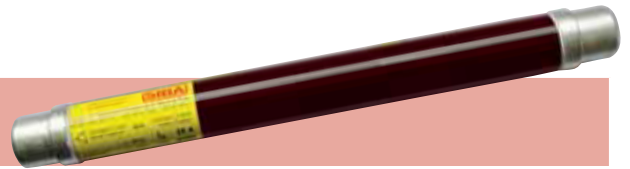

Nebenabmessung / Variant dimension

Einsatz / Application

Luft- und gasisolierte Mittelspannungsschaltanlagen / Air and gas insulated switchgear
Für Innen- und Freiluftanwendungen / Indoor and outdoor application

Verpackung / Packing 1 Stück / 1 piece

Betriebsklasse / Class	IEC 60282-1	VDE 0670-4
Teilbereich / Back-up	DIN 43 625	

Bemessungs- spannung Rated Voltage	Artikel Article	Bemessungsstrom Rated Current	Länge "e" Length "e"	Durchmesser D Diameter D
kV		A	mm	mm
10/17,5	30 231 13	6,3 - 40	442	53
	30 232 13	50 - 80		67
	30 233 13	100 - 160 _{RC125}		85
	30 233 14	200 _{RC140}		85

Bemessungs- strom Rated Current	Artikel Nr. Article No.	Gewicht Weight	Bemessungs- Ausschaltstrom Rated Breaking Current - I ₁	Minimaler Ausschaltstrom Min. Breaking Current - I ₃	Schmelzintegral Pre-Arcing I ² t-Value	Ausschaltintegral Total I ² t-Value		Leistungs- abgabe Power Loss	Kaltwider- stand Cold Resistance
						U _n min	U _n max		
A		kg/1	kA	A	A ² s	A ² s	A ² s	W	mΩ
6,3	30 231 13.6,3	2,2	63	22	45	210	360	21	397
10	30 231 13.10	2,2	63	34	75	350	560	38	252
16	30 231 13.16	2,2	63	56	250	1.100	2.000	37	116
20	30 231 13.20	2,2	63	70	640	2.900	4.800	42	62
25	30 231 13.25	2,2	63	90	1.050	4.700	7.500	56	48
31,5	30 231 13.31,5	2,2	63	110	1.700	6.600	12.000	69	39
40	30 231 13.40	2,2	63	140	2.900	12.000	19.000	84	29
50	30 232 13.50	2,9	63	170	5.700	20.000	33.000	101	21
63	30 232 13.63	2,9	63	210	10.700	40.000	66.000	106	16
80	30 232 13.80	2,9	63	280	17.500	74.000	135.000	137	11
100	30 233 13.100	5,4	63	320	28.000	134.000	215.000	182	8,7
125	30 233 13.125	5,4	63	390	47.000	225.000	360.000	229	7,5
160 _{RC125}	30 233 13.160	5,4	63	600	62.000	290.000	475.000	142	6,4
200 _{RC140}	30 233 14.200	5,4	63	800	78.000	360.000	595.000	148	5,2

RC = bitte Seite 13 beachten
please refer to page 13

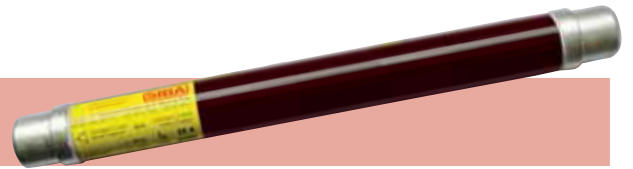

10/17,5 kV "e" = 442 mm

Zeit/Strom-Kennlinie
Time-current characteristic

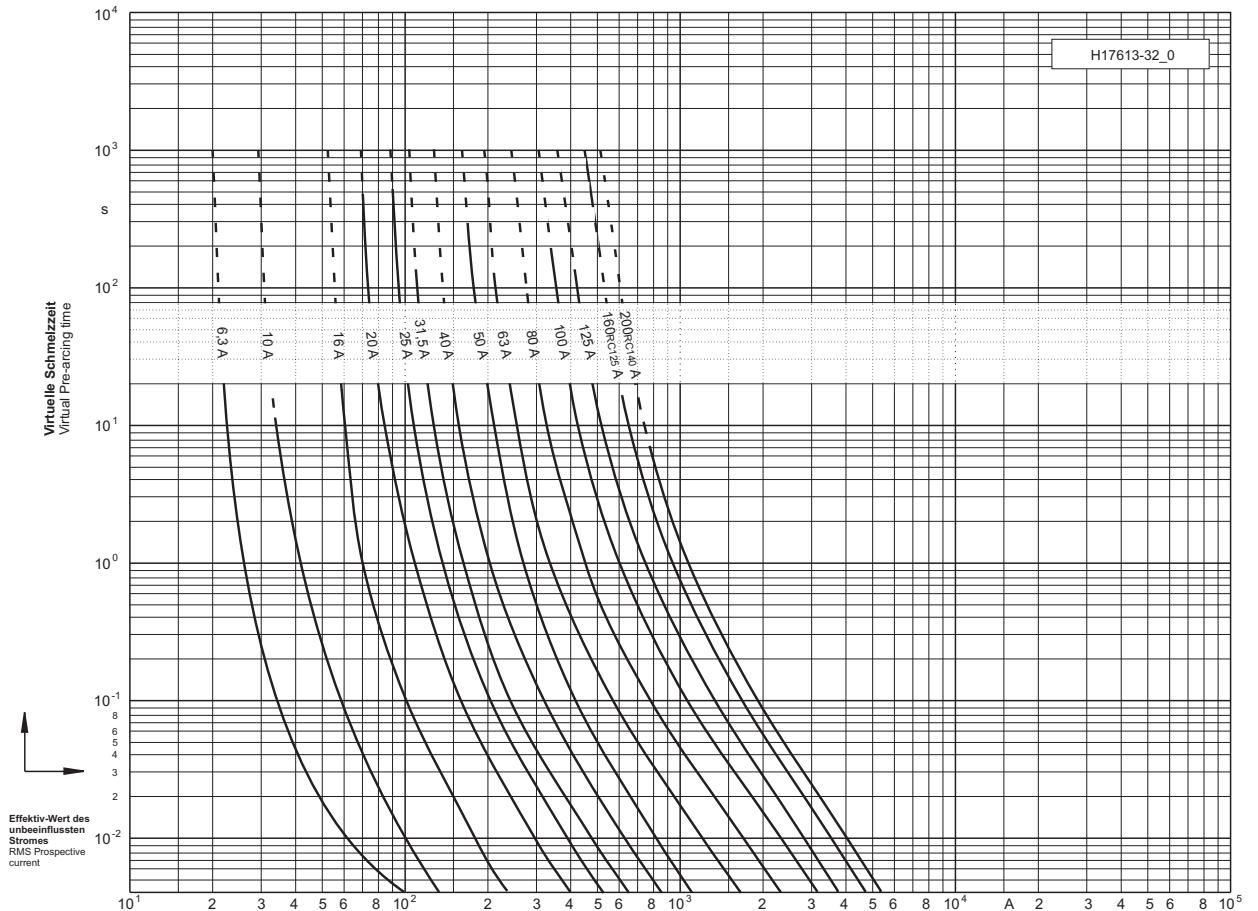

Durchlass-Strom
Cut-off current

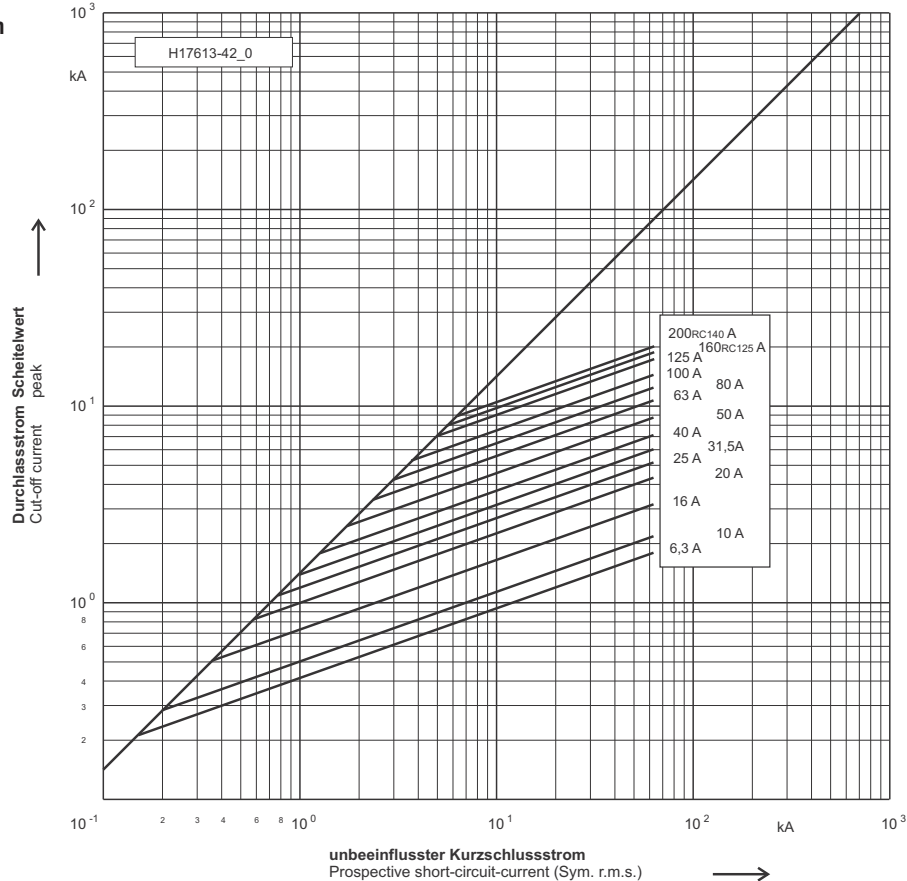

10/24 kV "e" = 442 mm

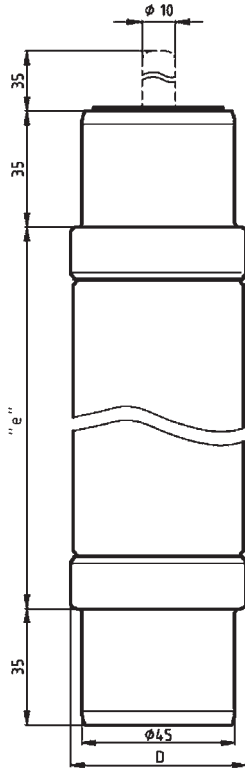
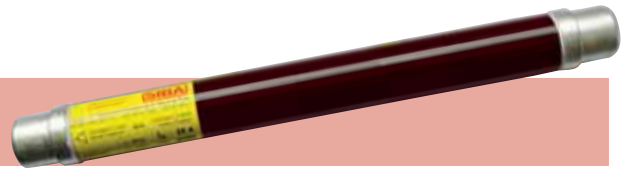

Vorzugsabmessung / Standard dimension

Einsatz / Application

Luft- und gasisolierte Mittelspannungsschaltanlagen / Air and gas insulated switchgear
Für Innen- und Freiluftanwendungen / Indoor and outdoor application

Verpackung / Packing 1 Stück / 1 piece

Betriebsklasse / Class	IEC 60282-1	VDE 0670-4
Teilbereich / Back-up	DIN 43 625	

Bemessungs- spannung Rated Voltage	Artikel Article	Bemessungsstrom Rated Current	Länge "e" Length "e"	Durchmesser D Diameter D
kV		A	mm	mm
10/24	30 006 13	6,3 - 40	442	53
	30 014 13	50 - 80		67
	30 022 13	100 - 160RC100		85
	30 022 14	200RC112		87

Bemessungs- strom Rated Current	Artikel Nr. Article No.	Gewicht Weight	Bemessungs- Ausschaltstrom Rated Breaking Current - I ₁	Minimaler Ausschaltstrom Min. Breaking Current - I ₃	Schmelzintegral Pre-Arcing I ² t-Value	Ausschaltintegral Total I ² t-Value		Leistungs- abgabe Power Loss	Kaltwider- stand Cold Resistance
						U _n min	U _n max		
A		kg/1	kA	A	A ² s	A ² s	A ² s	W	mΩ
6,3	30 006 13.6,3	2,2	63	22	45	210	360	29	546
10	30 006 13.10	2,2	63	34	75	350	560	52	347
16	30 006 13.16	2,2	63	56	250	1.100	2.000	59	151
20	30 006 13.20	2,2	63	70	640	2.900	4.800	46	83
25	30 006 13.25	2,2	63	90	1.050	4.700	7.500	56	62
31,5	30 006 13.31,5	2,2	63	110	1.700	6.600	12.000	72	52
40	30 006 13.40	2,2	63	140	2.900	12.000	19.000	106	43
50	30 014 13.50	2,9	63	170	5.700	20.000	33.000	108	29
63	30 014 13.63	2,9	63	210	10.700	40.000	66.000	132	22
80	30 014 13.80	2,9	63	280	21.000	78.000	140.000	174	16
100	30 022 13.100	5,4	63	320	28.000	160.000	255.000	234	13
125	30 022 13.125	5,4	63	390	47.000	180.000	300.000	320	11
160RC100	30 022 13.160	5,4	63	600	62.000	237.000	395.000	146	9
200RC112	30 022 14.200	5,4	63	800	75.000	290.000	470.000	157	8

RC = bitte Seite 13 beachten
please refer to page 13

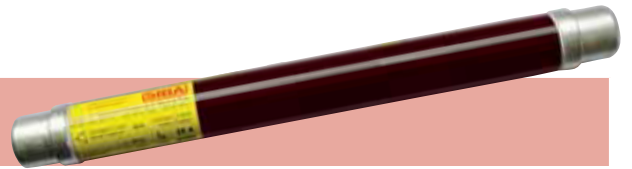

10/24 kV "e" = 442 mm

Zeit/Strom-Kennlinie
Time-current characteristic

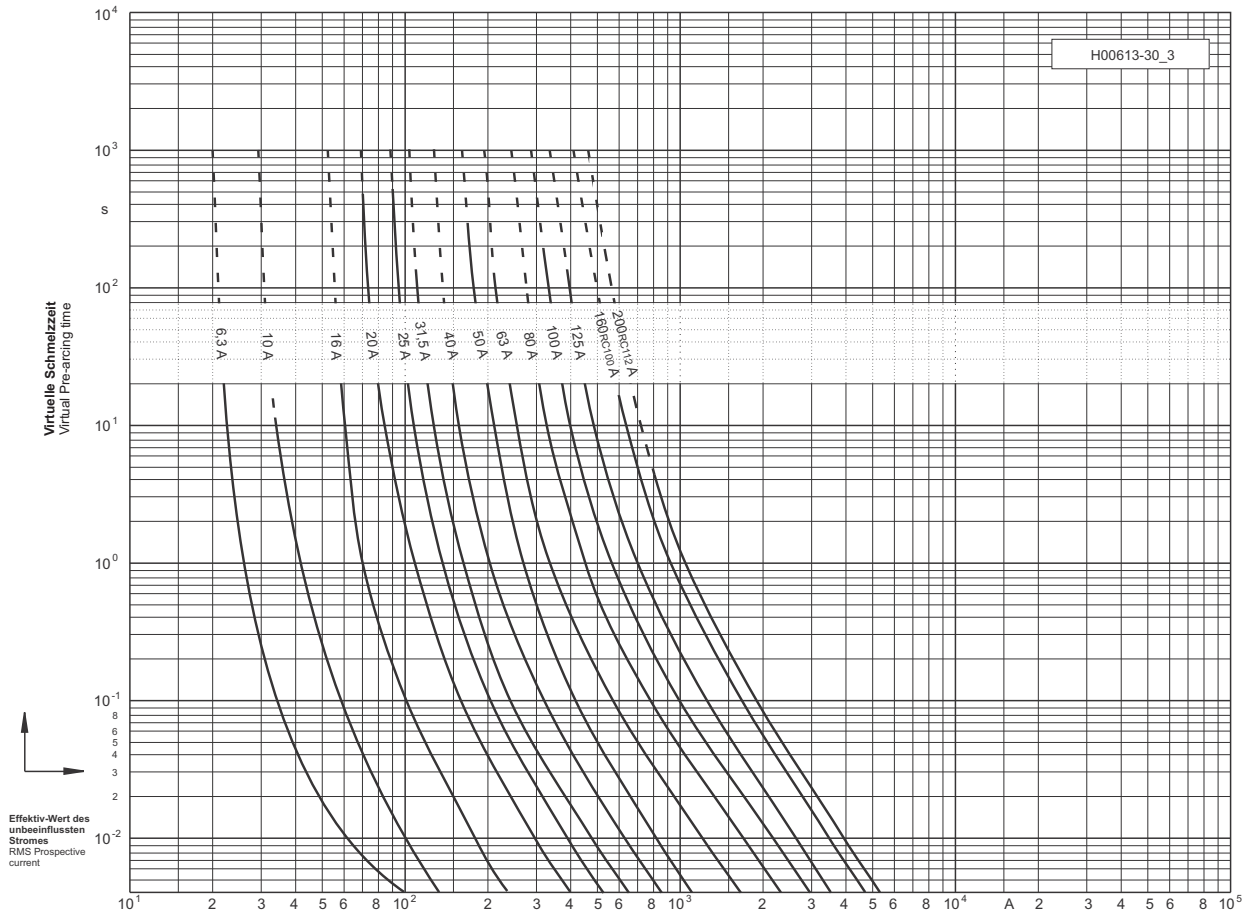

Durchlass-Strom
Cut-off current

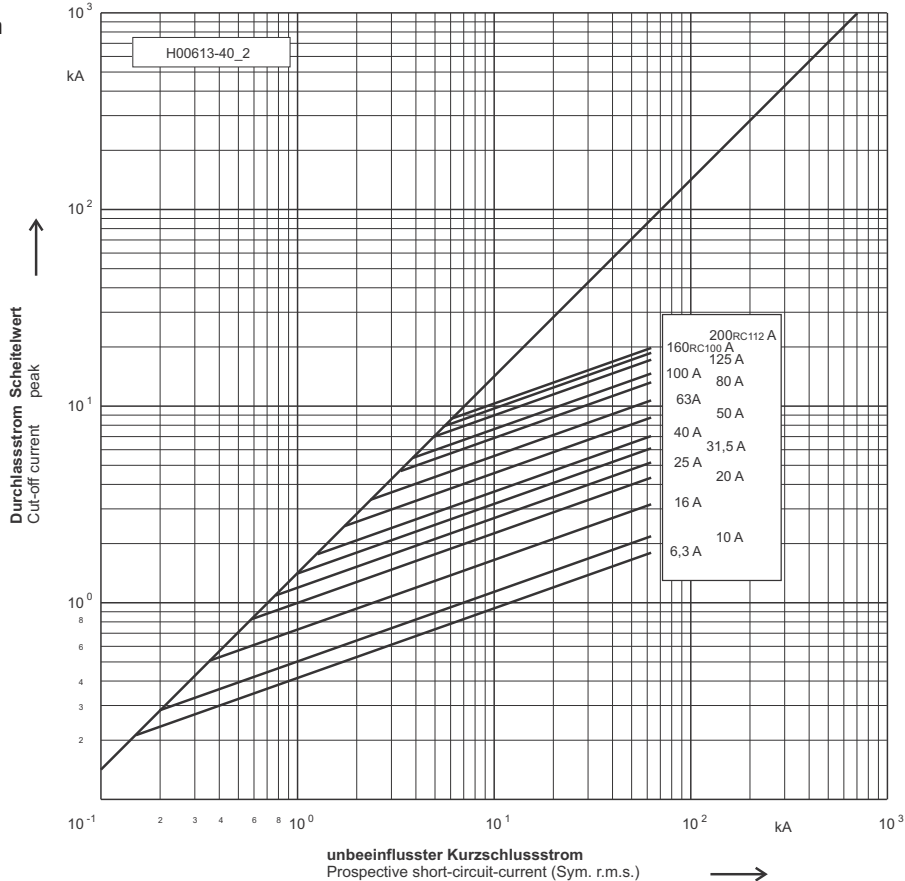

10/24 kV "e" = 292 mm

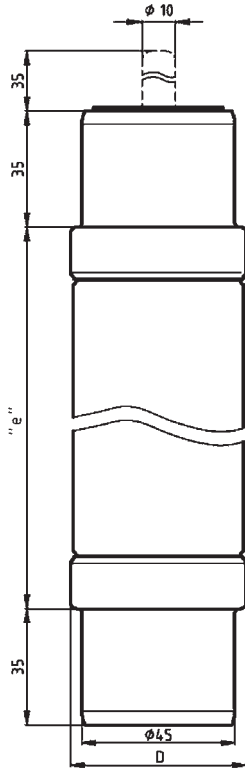

Nebenabmessung / Variant dimension

Einsatz / Application

Luft- und gasisolierte Mittelspannungsschaltanlagen / Air and gas insulated switchgear
Für Innen- und Freiluftanwendungen / Indoor and outdoor application

Verpackung / Packing 1 Stück / 1 piece

Betriebsklasse / Class	IEC 60282-1	VDE 0670-4
Teilbereich / Back-up	DIN 43 625	

Bemessungs- spannung Rated Voltage	Artikel Article	Bemessungsstrom Rated Current	Länge "e" Length "e"	Durchmesser D Diameter D
kV		A	mm	mm
10/24	30 180 13	6,3 - 16	292	53
	30 225 13	20 - 63		67

Bemessungs- strom Rated Current	Artikel Nr. Article No.	Gewicht Weight	Bemessungs- Ausschaltstrom Rated Breaking Current - I ₁	Minimaler Ausschaltstrom Min. Breaking Current - I ₃	Schmelzintegral Pre-Arcing I ² t-Value	Ausschaltintegral Total I ² t-Value		Leistungs- abgabe Power Loss	Kaltwider- stand Cold Resistance
						U _n min	U _n max		
A		kg/1	kA	A	A ² s	A ² s	A ² s	W	mΩ
6,3	30 180 13.6,3	1,6	31,5	22	45	210	360	29	546
10	30 180 13.10	1,6	31,5	34	75	350	560	52	347
16	30 180 13.16	1,6	31,5	56	250	1.100	2.000	59	160
20	30 225 13.20	2,0	31,5	70	640	2.900	4.800	46	86
25	30 225 13.25	2,0	31,5	90	1.050	4.700	7.500	56	66
31,5	30 225 13.31,5	2,0	31,5	110	1.700	6.600	12.000	72	53
40	30 225 13.40	2,0	31,5	140	2.900	12.000	19.000	106	43
50	30 225 13.50	2,0	31,5	170	5.700	20.000	33.000	108	29
63	30 225 13.63	2,0	31,5	210	10.700	40.000	66.000	132	21

10/24 kV "e" = 292 mm



**Zeit/Strom-
Kennlinie**
Time-current
characteristic

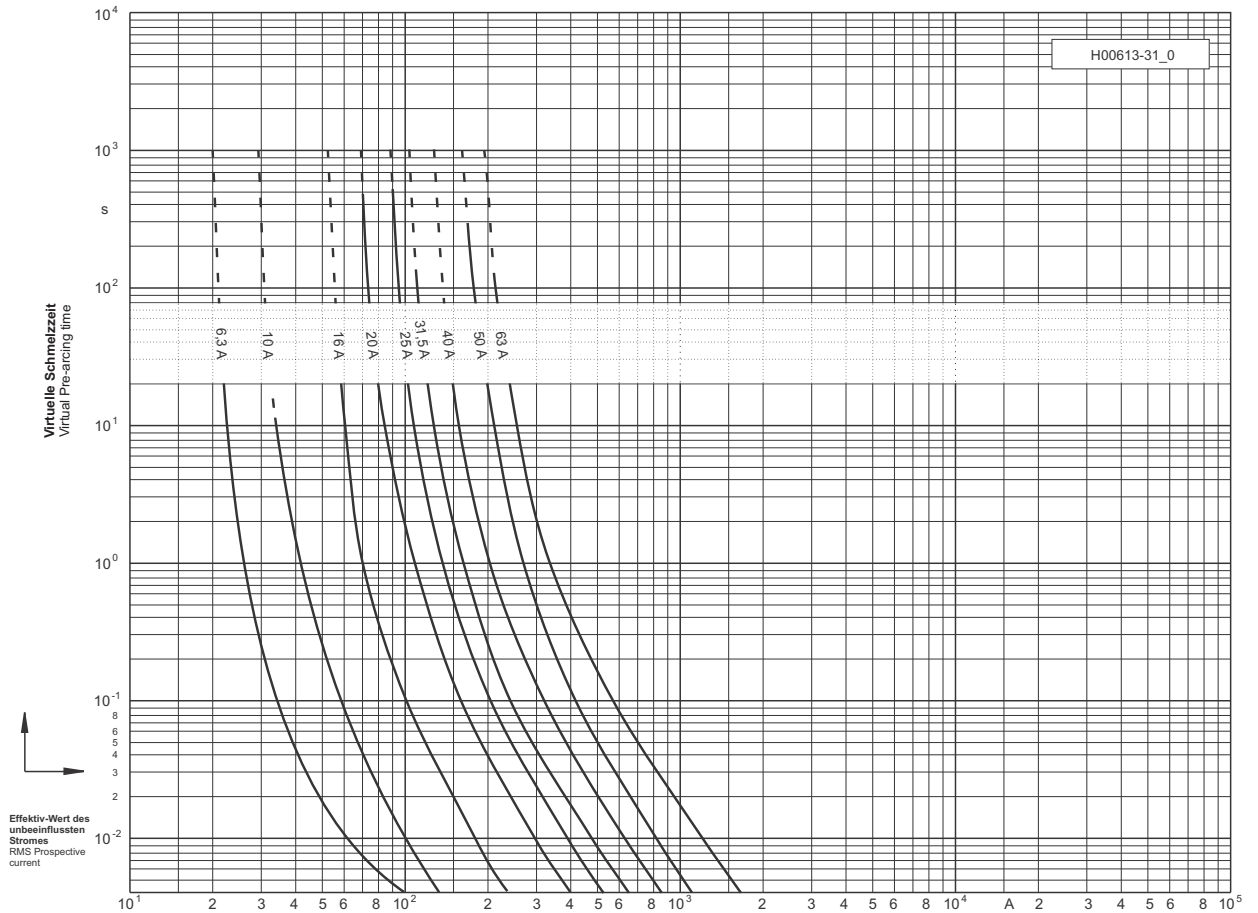

Durchlass-Strom
Cut-off current

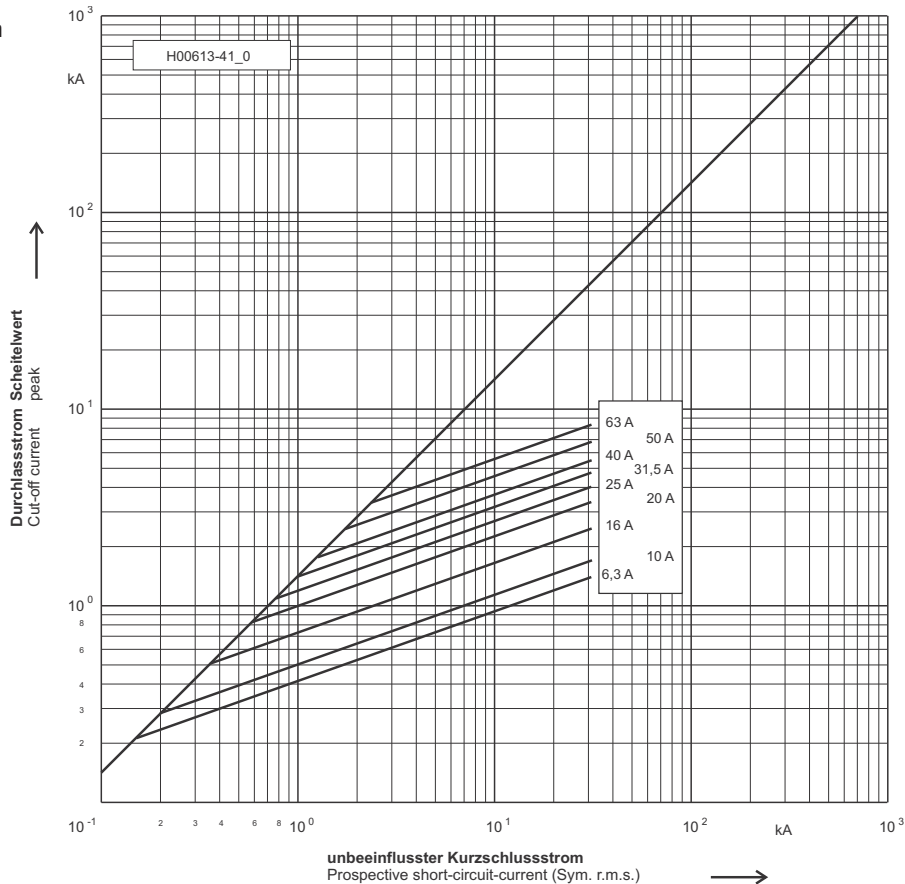

10/24 kV "e" = 537 mm

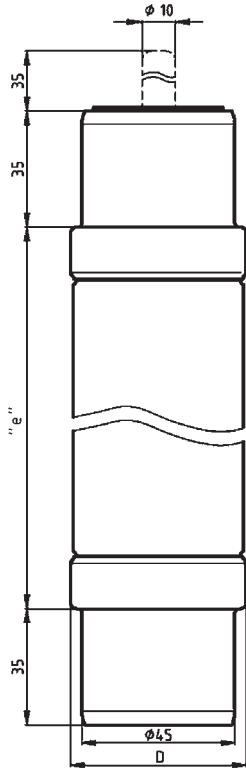

Nebenabmessung / Variant dimension

Einsatz / Application

Luft- und gasisolierte Mittelspannungsschaltanlagen / Air and gas insulated switchgear
Für Innen- und Freiluftanwendungen / Indoor and outdoor application

Verpackung / Packing 1 Stück / 1 piece

Betriebsklasse / Class	IEC 60282-1	VDE 0670-4
Teilbereich / Back-up	DIN 43 625	

Bemessungs- spannung Rated Voltage	Artikel Article	Bemessungsstrom Rated Current	Länge "e" Length "e"	Durchmesser D Diameter D
kV		A	mm	mm
10/24	30 203 13	6,3 - 40	537	53
	30 204 13	50 - 80		67
	30 196 13	100 - 160 _{RC112}		85
	30 196 14	200 _{RC125}		85
	30 196 14	250 _{RC140}		88

Bemessungs- strom Rated Current	Artikel Nr. Article No.	Gewicht Weight	Bemessungs- Ausschaltstrom Rated Breaking Current - I ₁	Minimaler Ausschaltstrom Min. Breaking Current - I ₃	Schmelzintegral Pre-Arcing I ² t-Value	Ausschaltintegral Total I ² t-Value		Leistungs- abgabe Power Loss	Kaltwider- stand Cold Resistance
						U _n min	U _n max		
A		kg/1	kA	A	A ² s	A ² s	A ² s	W	mΩ
6,3	30 203 13.6,3	2,8	63	22	45	210	360	29	546
10	30 203 13.10	2,8	63	34	75	350	560	52	347
16	30 203 13.16	2,8	63	56	250	1.100	2.000	59	151
20	30 203 13.20	2,8	63	70	640	2.900	4.800	46	83
25	30 203 13.25	2,8	63	90	1.050	4.700	7.500	56	62
31,5	30 203 13.31,5	2,8	63	110	1.700	6.600	12.000	72	52
40	30 203 13.40	2,8	63	140	2.900	12.000	19.000	106	41
50	30 204 13.50	3,7	63	170	5.700	20.000	33.000	108	29
63	30 204 13.63	3,7	63	210	10.700	40.000	66.000	132	22
80	30 204 13.80	3,7	63	280	21.000	78.000	140.000	174	16
100	30 196 13.100	6,8	63	320	28.000	160.000	255.000	239	13
125	30 196 13.125	6,8	63	390	47.000	180.000	300.000	320	11
160 _{RC112}	30 196 13.160	6,8	63	600	62.000	227.000	395.000	178	9,0
200 _{RC125}	30 196 14.200	6,8	63	800	75.000	290.000	470.000	179	8,0
250 _{RC140}	30 196 14.250	6,8	63	1.000	175.000	675.000	1.100.000	199	6,5

RC = bitte Seite 13 beachten
please refer to page 13



10/24 kV "e" = 537 mm

Zeit/Strom-Kennlinie
Time-current characteristic

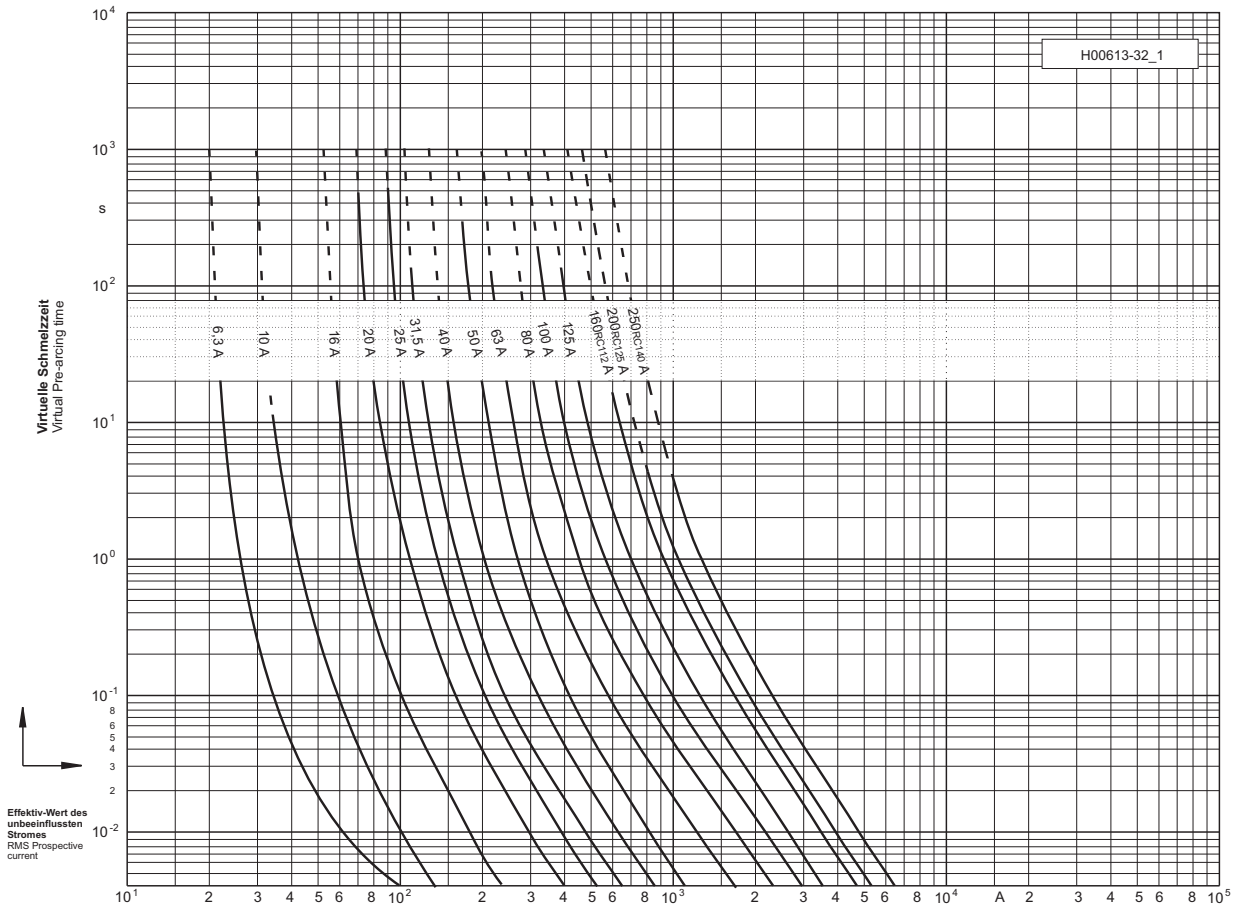

Durchlass-Strom
Cut-off current

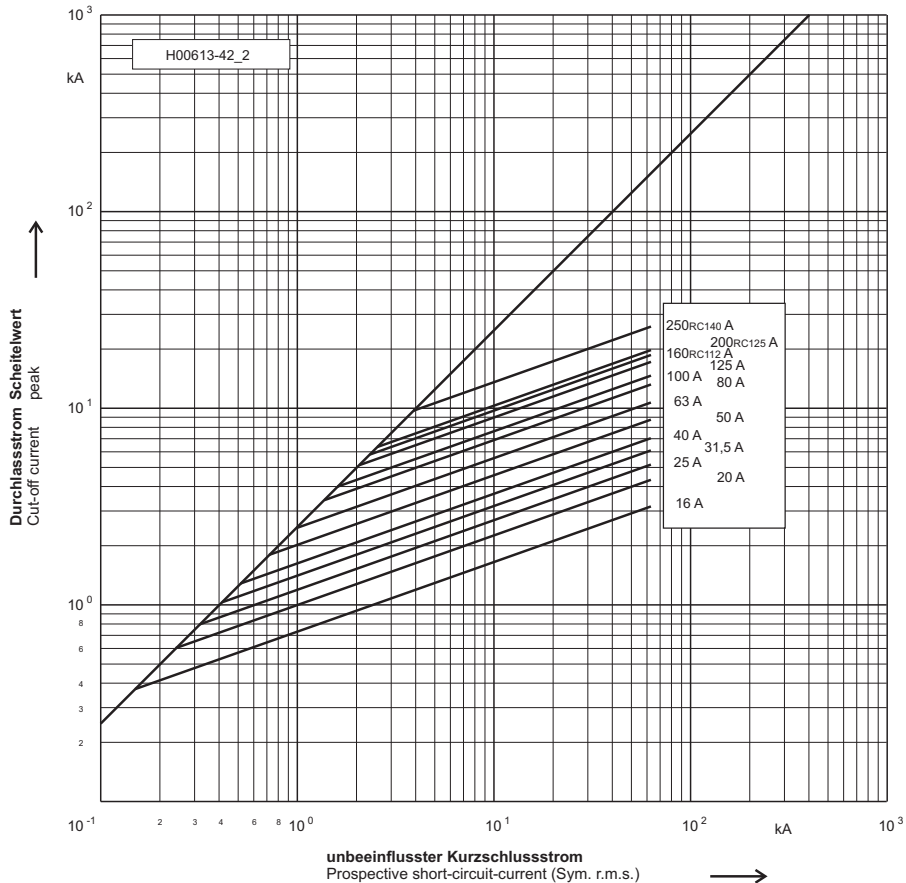

20/36 kV "e" = 537 mm

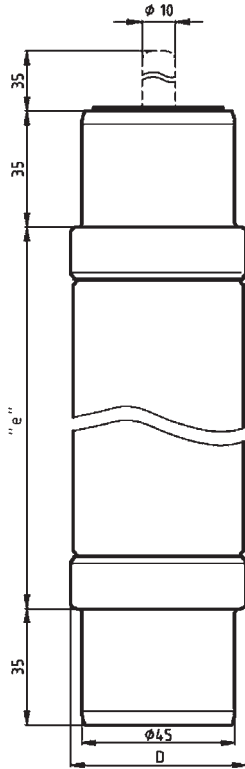
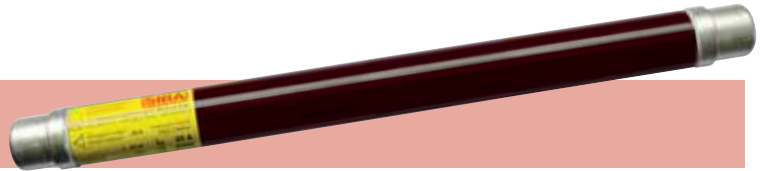

Vorzugsabmessung / Standard dimension

Einsatz / Application

Luft- und gasisolierte Mittelspannungsschaltanlagen / Air and gas insulated switchgear
Für Innen- und Freiluftanwendungen / Indoor and outdoor application

Verpackung / Packing 1 Stück / 1 piece

Betriebsklasse / Class	IEC 60282-1	VDE 0670-4
Teilbereich / Back-up	DIN 43 625	

Bemessungs- spannung Rated Voltage	Artikel Article	Bemessungsstrom Rated Current	Länge "e" Length "e"	Durchmesser D Diameter D
kV		A	mm	mm
20/36	30 008 13	6,3 - 25	537	53
	30 016 13	31,5 - 40		67
	30 024 13	50 - 100 ^{RC71}		85

Bemessungs- strom Rated Current	Artikel Nr. Article No.	Gewicht Weight	Bemessungs- Ausschaltstrom Rated Breaking Current - I ₁	Minimaler Ausschaltstrom Min. Breaking Current - I ₃	Schmelzintegral Pre-Arcing I ² t-Value	Ausschaltintegral Total I ² t-Value		Leistungs- abgabe Power Loss	Kaltwider- stand Cold Resistance
						U _n min	U _n max		
A		kg/1	kA	A	A ² s	A ² s	A ² s	W	mΩ
6,3	30 008 13.6,3	2,6	40	22	27	180	300	44	819
10	30 008 13.10	2,6	40	34	68	470	740	78	521
16	30 008 13.16	2,6	40	56	140	850	1.500	101	254
20	30 008 13.20	2,6	40	70	540	3.100	5.500	67	129
25	30 008 13.25	2,6	40	90	920	5.900	9.300	90	99
31,5	30 016 13.31,5	3,5	40	110	1.400	7.400	13.000	135	88
40	30 016 13.40	3,5	40	140	2.500	13.800	22.700	173	66
50	30 024 13.50	6,0	40	170	4.700	31.000	43.000	214	48
63	30 024 13.63	6,0	40	210	8.700	61.000	88.000	255	35
80 ^{RC63}	30 024 13.80	6,0	40	280	17.000	88.000	171.000	145	23
100 ^{RC71}	30 024 13.100	6,0	40	350	18.500	67.000	107.000	162	21

RC = bitte Seite 13 beachten
please refer to page 13

20/36 kV "e" = 537 mm



Zeit/Strom-Kennlinie
Time-current characteristic

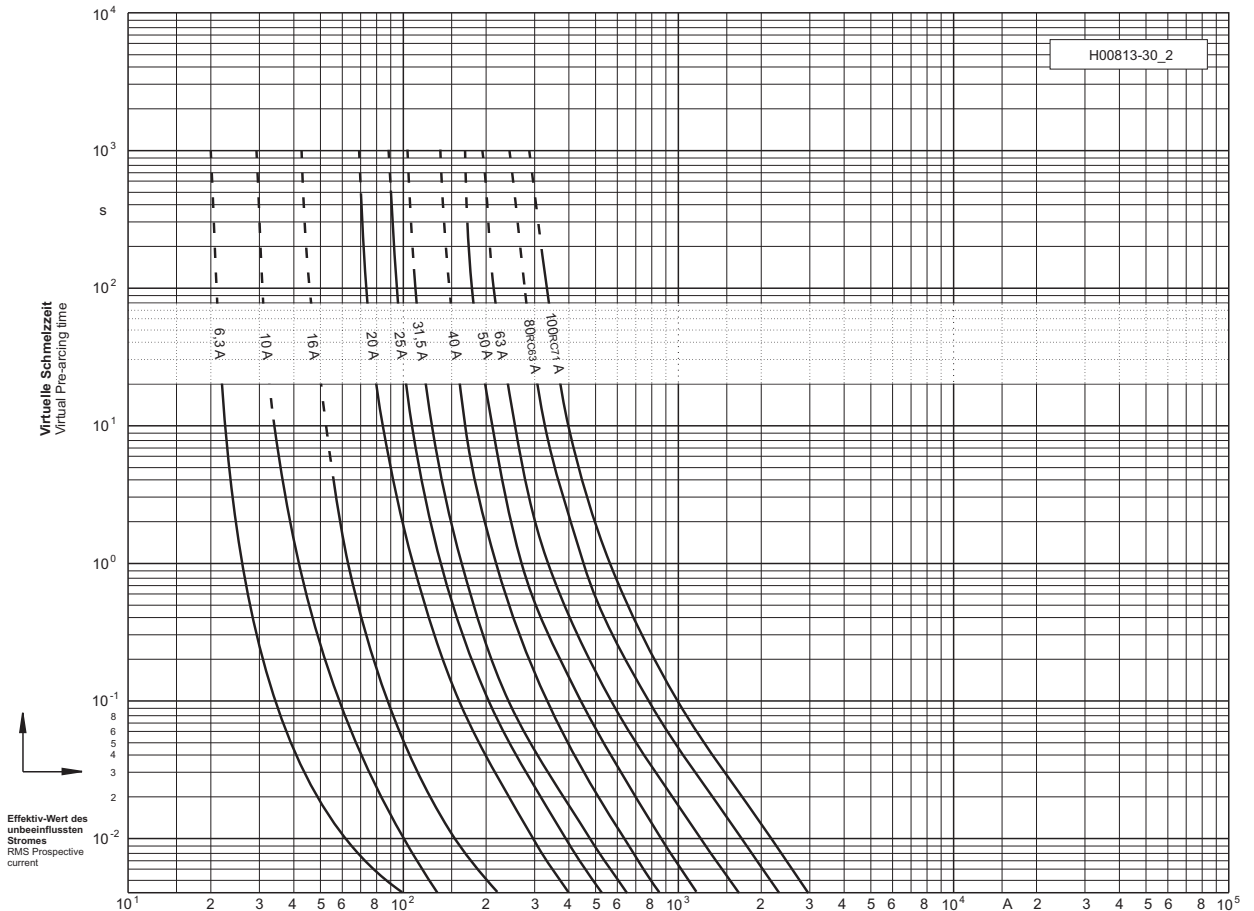

Durchlass-Strom
Cut-off current

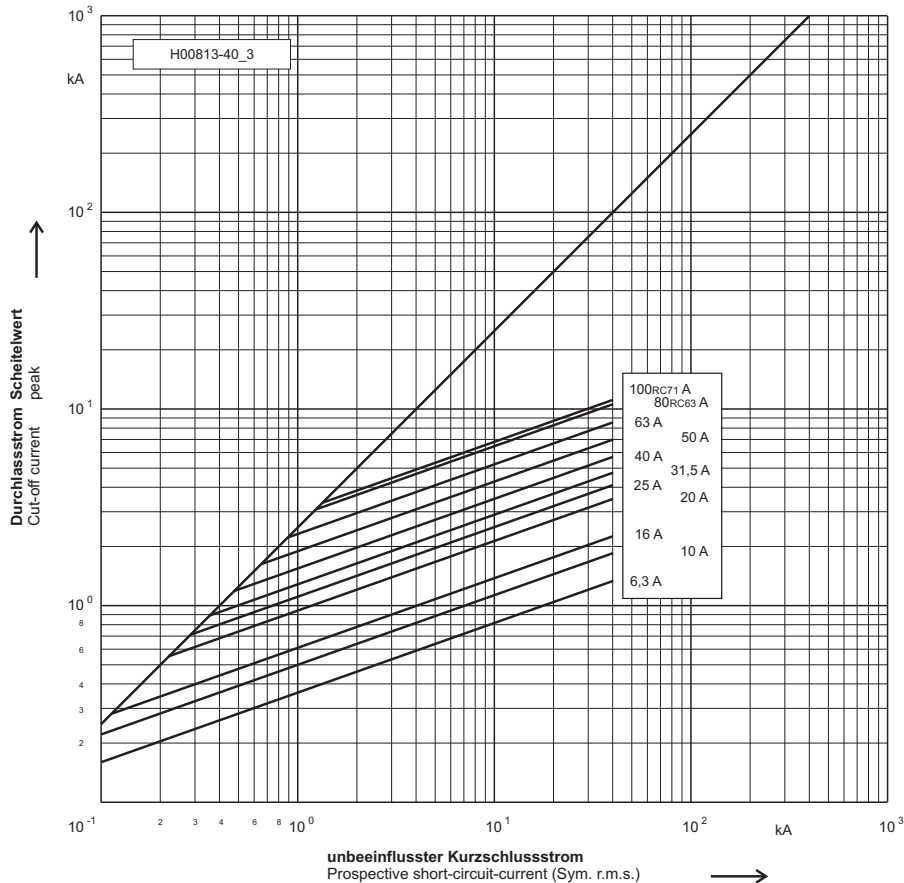

20/36 kV "e" = 292 mm

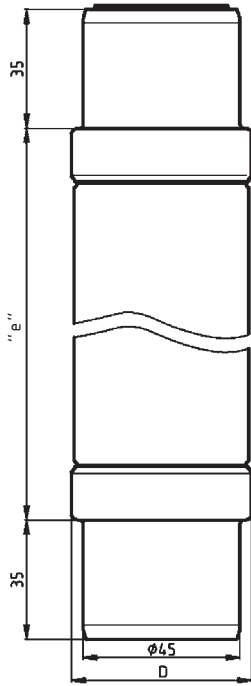

Nebenabmessung / Variant dimension

Einsatz / Application

Luft- und gasisolierte Mittelspannungsschaltanlagen / Air and gas insulated switchgear
Für Innen- und Freiluftanwendungen / Indoor and outdoor application

Verpackung / Packing 1 Stück / 1 piece

Betriebsklasse / Class Teilbereich / Back-up	IEC 60282-1 DIN 43 625	VDE 0670-4
--	---	-------------------

Bemessungs- spannung Rated Voltage	Artikel Article	Bemessungsstrom Rated Current	Länge "e" Length "e"	Durchmesser D Diameter D
kV		A	mm	mm
20/36	30 454 11	6,3 - 16	292	67

Bemessungs- strom Rated Current	Artikel Nr. Article No.	Gewicht Weight	Bemessungs- Ausschaltstrom Rated Breaking Current - I ₁	Minimaler Ausschaltstrom Min. Breaking Current - I ₃	Schmelzintegral Pre-Arcing I ² t-Value	Ausschaltintegral Total I ² t-Value		Leistungs- abgabe Power Loss	Kaltwider- stand Cold Resistance
						U _n min	U _n max		
A		kg/1	kA	A	A ² s	A ² s	A ² s	W	mΩ
6,3	30 454 11.6,3	2,0	20	22	27	180	300	49	819
10	30 454 11.10	2,0	20	34	68	470	740	87	521
16	30 454 11.16	2,0	20	56	140	850	1.500	83	254

20/36 kV "e" = 292 mm



Zeit/Strom-Kennlinie
Time-current characteristic

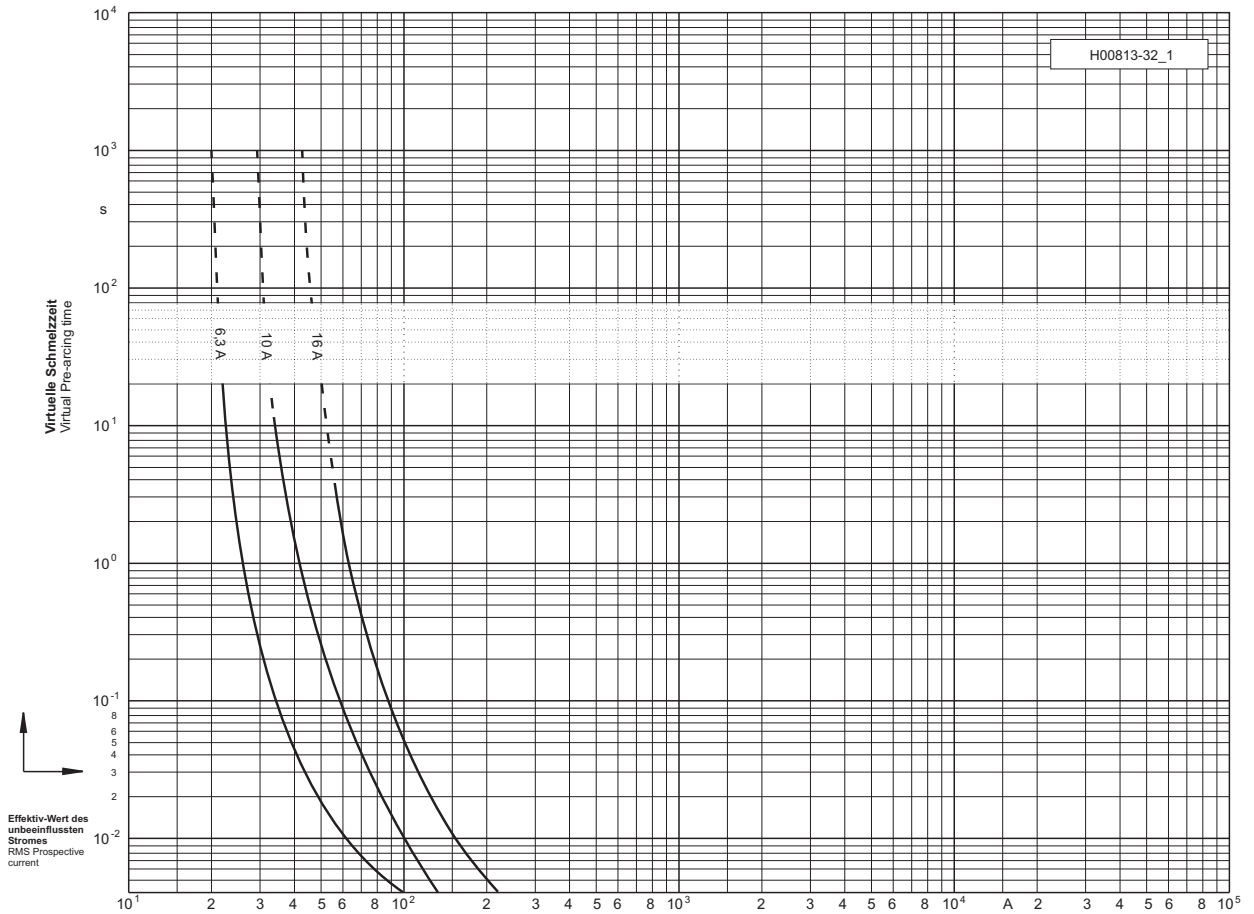

Durchlass-Strom
Cut-off current

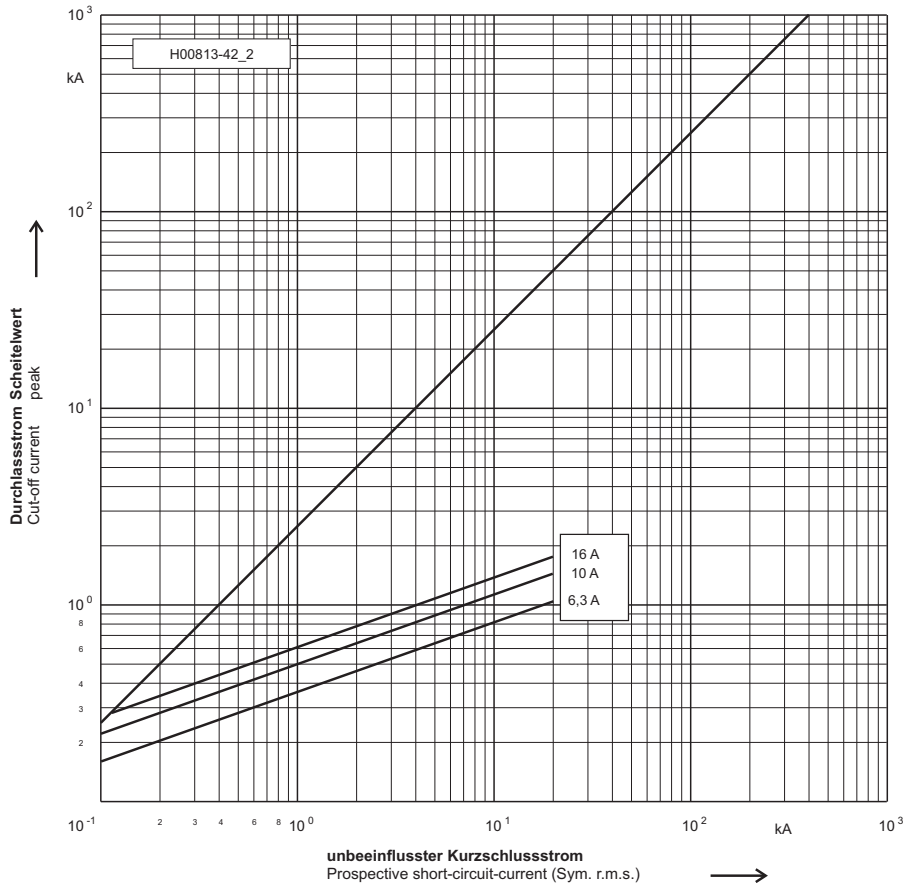

20/36 kV "e" = 442 mm

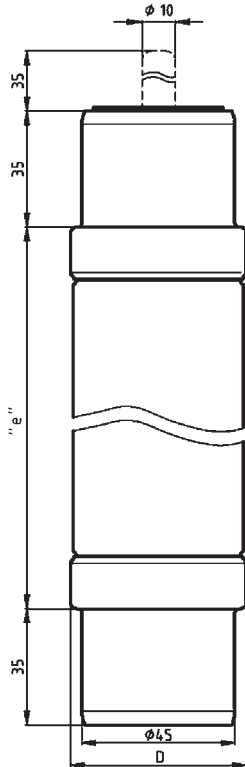
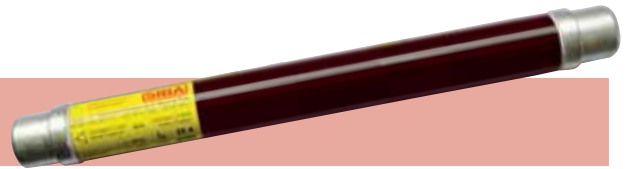

Nebenabmessung / Variant dimension

Einsatz / Application

Luft- und gasisolierte Mittelspannungsschaltanlagen / Air and gas insulated switchgear
Für Innen- und Freiluftanwendungen / Indoor and outdoor application

Verpackung / Packing 1 Stück / 1 piece

Betriebsklasse / Class	IEC 60282-1	VDE 0670-4
Teilbereich / Back-up	DIN 43 625	

Bemessungs- spannung Rated Voltage	Artikel Article	Bemessungsstrom Rated Current	Länge "e" Length "e"	Durchmesser D Diameter D
kV		A	mm	mm
20/36	30 181 13	6,3 - 16	442	53
	30 295 13	20 - 25		67

Bemessungs- strom Rated Current	Artikel Nr. Article No.	Gewicht Weight	Bemessungs- Ausschaltstrom Rated Breaking Current - I ₁	Minimaler Ausschaltstrom Min. Breaking Current - I ₃	Schmelzintegral Pre-Arcing I ² t-Value	Ausschaltintegral Total I ² t-Value		Leistungs- abgabe Power Loss	Kaltwider- stand Cold Resistance
						U _n min	U _n max		
A		kg/1	kA	A	A ² s	A ² s	A ² s	W	mΩ
6,3	30 181 13.6,3	2,2	20	22	45	210	360	44	819
10	30 181 13.10	2,2	20	34	75	350	560	78	521
16	30 181 13.16	2,2	20	56	250	1.100	3.000	74	241
20	30 295 13.20	2,9	20	70	640	2.900	4.800	66	129
25	30 295 13.25	2,9	20	90	1.050	4.700	7.500	87	99

20/36 kV "e" = 442 mm

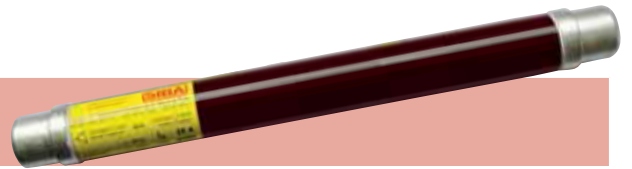

**Zeit/Strom-
Kennlinie**
Time-current
characteristic

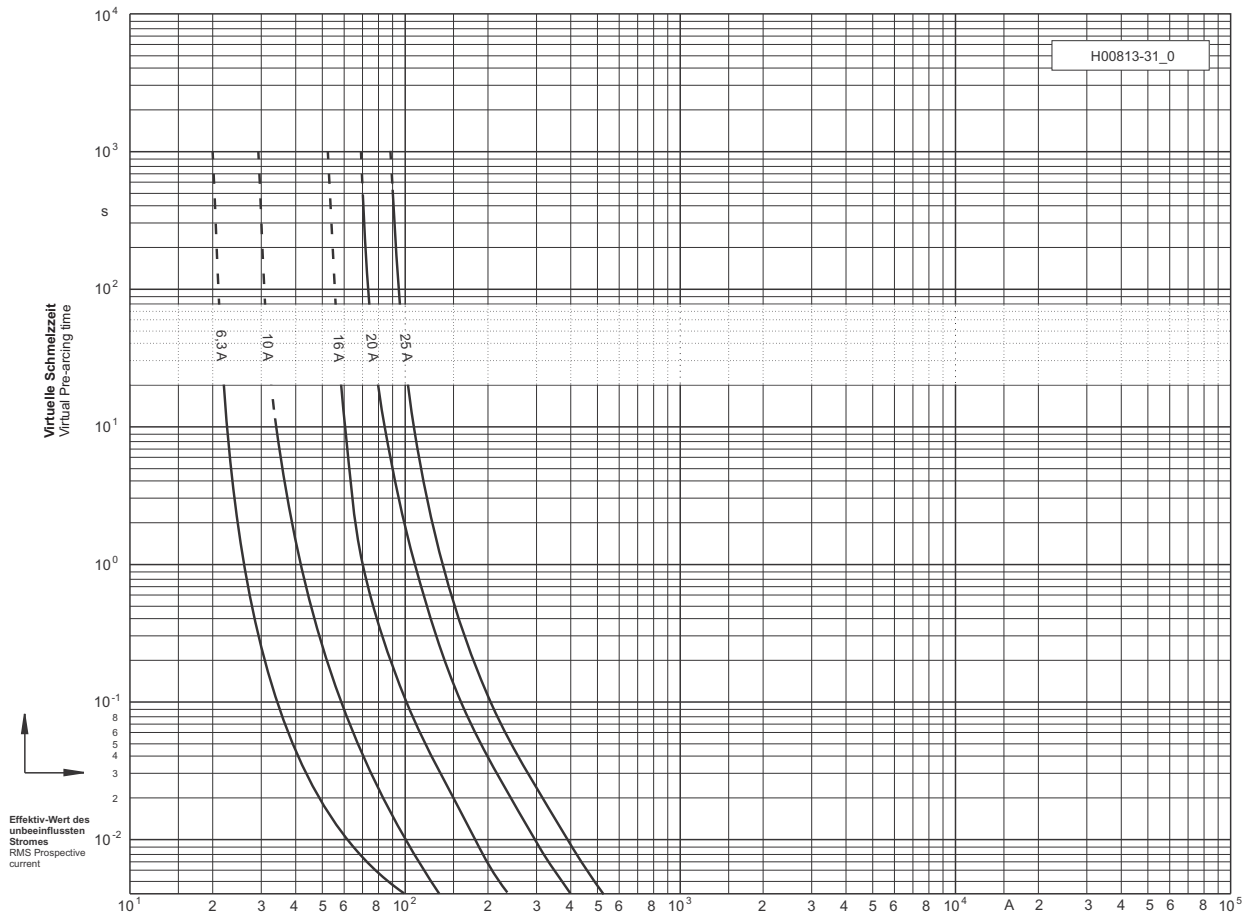

Durchlass-Strom
Cut-off current

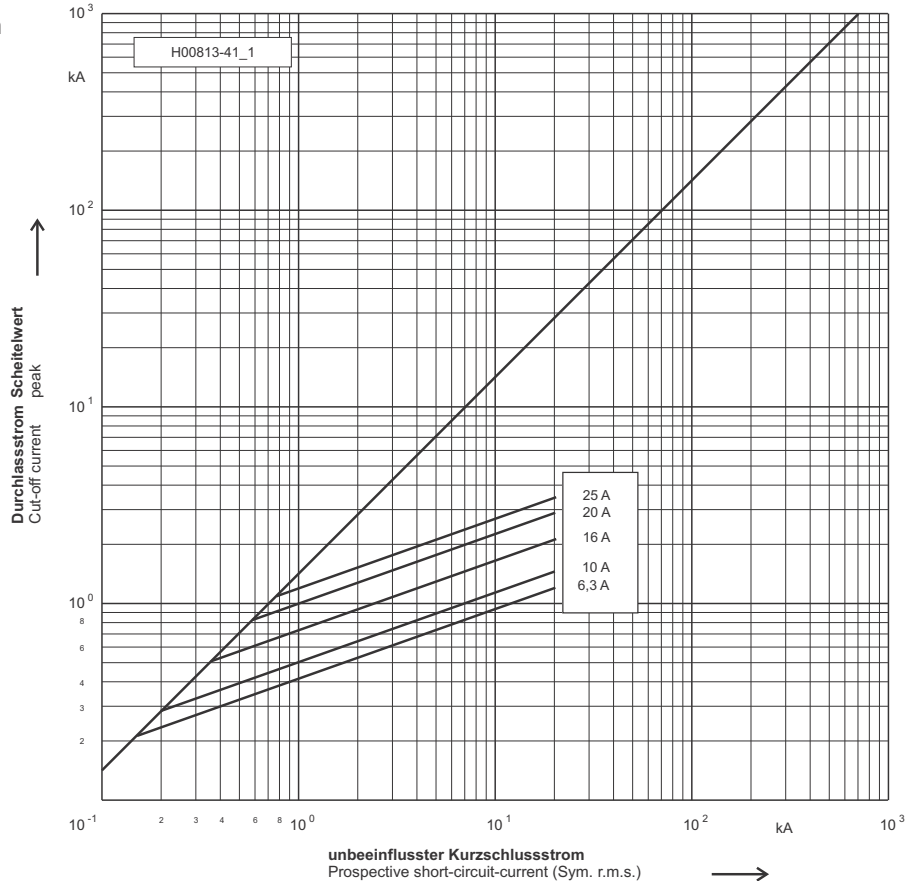

27 kV

"e" = 442 mm

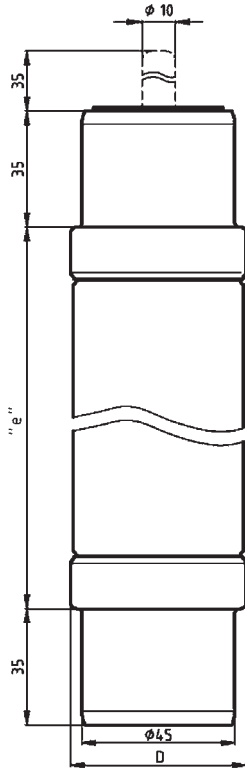
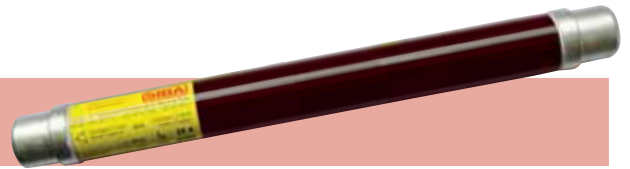

Sonderausführung / Special design

Einsatz / Application

Luft- und gasisolierte Mittelspannungsschaltanlagen / Air and gas insulated switchgear
Für Innen- und Freiluftanwendungen / Indoor and outdoor application

Verpackung / Packing 1 Stück / 1 piece

Betriebsklasse / Class	IEC 60282-1	VDE 0670-4
Teilbereich / Back-up	DIN 43 625	

Bemessungs- spannung Rated Voltage	Artikel Article	Bemessungsstrom Rated Current	Länge "e" Length "e"	Durchmesser D Diameter D
kV		A	mm	mm
27	30 289 13	6,3 - 16	442	53
	30 288 13	20 - 63		67
	30 287 13	80 - 125		85

Bemessungs- strom Rated Current	Artikel Nr. Article No.	Gewicht Weight	Bemessungs- Ausschaltstrom Rated Breaking Current - I ₁	Minimaler Ausschaltstrom Min. Breaking Current - I ₃	Schmelzintegral Pre-Arcing I ² t-Value	Ausschaltintegral Total I ² t-Value		Leistungs- abgabe Power Loss	Kaltwider- stand Cold Resistance
						U _n min	U _n max		
A		kg/1	kA	A	A ² s	A ² s	A ² s	W	mΩ
6,3	30 289 13.6,3	2,2	63	22	45	210	360	32	595
10	30 289 13.10	2,2	63	34	75	350	560	56	380
16	30 289 13.16	2,2	63	56	250	1.100	2.000	68	185
20	30 288 13.20	2,9	63	70	640	2.900	4.800	49	93
25	30 288 13.25	2,9	63	90	1.050	4.700	7.500	59	70
31,5	30 288 13.31,5	2,9	63	110	1.700	6.600	12.000	79	58
40	30 288 13.40	2,9	63	140	2.900	12.000	19.000	109	44
50	30 288 13.50	2,9	63	170	5.700	20.000	33.000	119	32
63	30 288 13.63	2,9	63	210	10.700	40.000	66.000	144	23
80	30 287 13.80	5,4	63	280	21.000	78.000	140.000	174	16
100	30 287 13.100	5,4	63	320	33.000	130.000	210.000	234	13
125	30 287 13.125	5,4	63	390	47.000	180.000	390.000	320	11

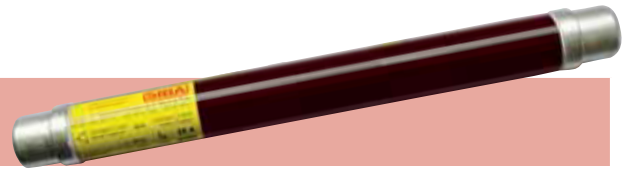

27 kV

"e" = 442 mm

Zeit/Strom-
Kennlinie
Time-current
characteristic

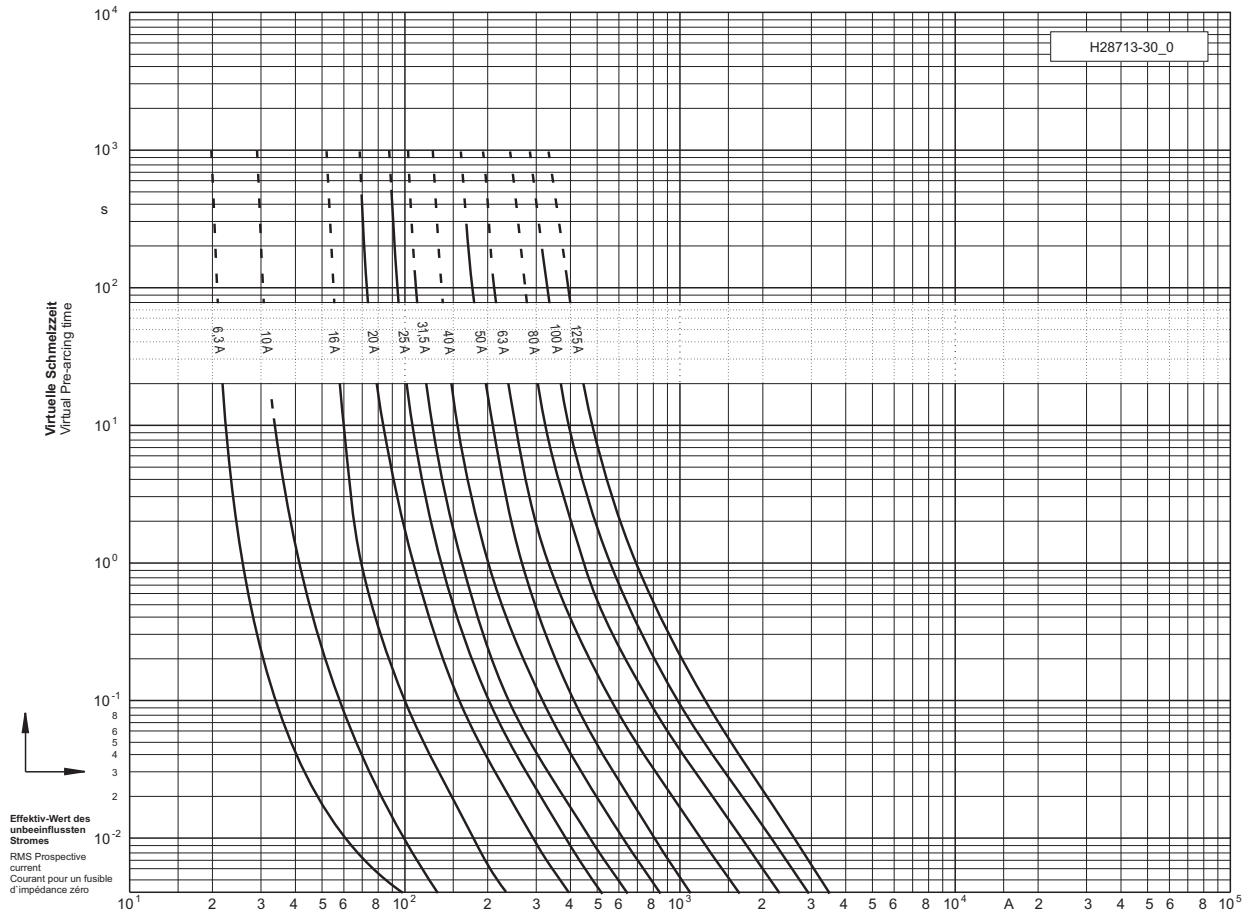

Durchlass-Strom
Cut-off current

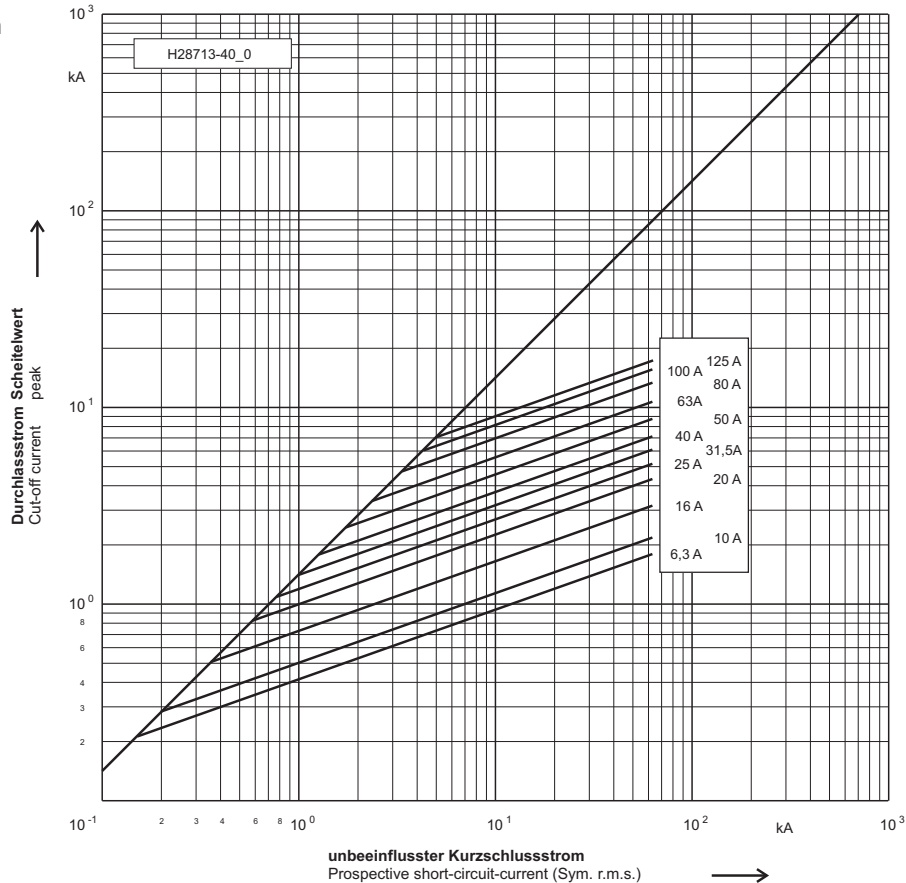

38,5 kV

"e" = 537 mm

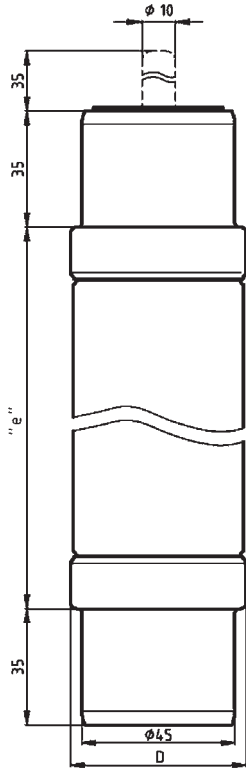
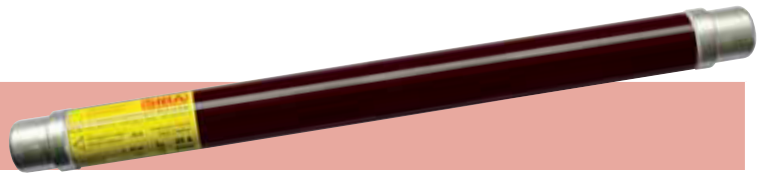

Sonderausführung / Special design

Einsatz / Application

Luft- und gasisolierte Mittelspannungsschaltanlagen / Air and gas insulated switchgear
Für Innen- und Freiluftanwendungen / Indoor and outdoor application

Verpackung / Packing 1 Stück / 1 piece

Betriebsklasse / Class	IEC 60282-1	VDE 0670-4
Teilbereich / Back-up	DIN 43 625	

Bemessungs- spannung Rated Voltage	Artikel Article	Bemessungsstrom Rated Current	Länge "e" Length "e"	Durchmesser D Diameter D
kV		A	mm	mm
38,5	30 337 13	6,3 - 10	537	53
	30 338 13	16 - 31,5		67
	30 339 13	40 - 63RC50		85

Bemessungs- strom Rated Current	Artikel Nr. Article No.	Gewicht Weight	Bemessungs- Ausschaltstrom Rated Breaking Current - I ₁	Minimaler Ausschaltstrom Min. Breaking Current - I ₃	Schmelzintegral Pre-Arcing I ² t-Value	Ausschalt- integral Total I ² t-Value	Leistungs- abgabe Power Loss	Kaltwider- stand Cold Resistance
A		kg/1	kA	A	A ² s	A ² s	W	mΩ
6,3	30 337 13.6,3	2,6	40	22	45	360	51	943
10	30 337 13.10	2,6	40	34	75	560	86	590
16	30 338 13.16	3,5	40	56	250	2.000	85	293
20	30 338 13.20	3,5	40	70	640	4.800	76	148
25	30 338 13.25	3,5	40	90	1.050	7.500	100	114
31,5	30 338 13.31,5	3,5	40	110	1.700	12.000	108	93
40	30 339 13.40	6,0	40	140	2.900	19.000	152	70
50	30 339 13.50	6,0	40	170	5.700	33.000	196	51
63RC50	30 339 13.63	6,0	40	210	10.700	66.000	171	30

RC = bitte Seite 13 beachten
please refer to page 13

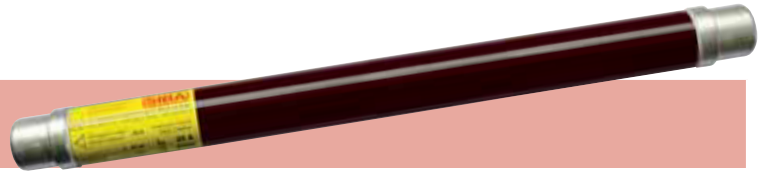

38,5 kV

"e" = 537 mm

**Zeit/Strom-
Kennlinie**
Time-current
characteristic

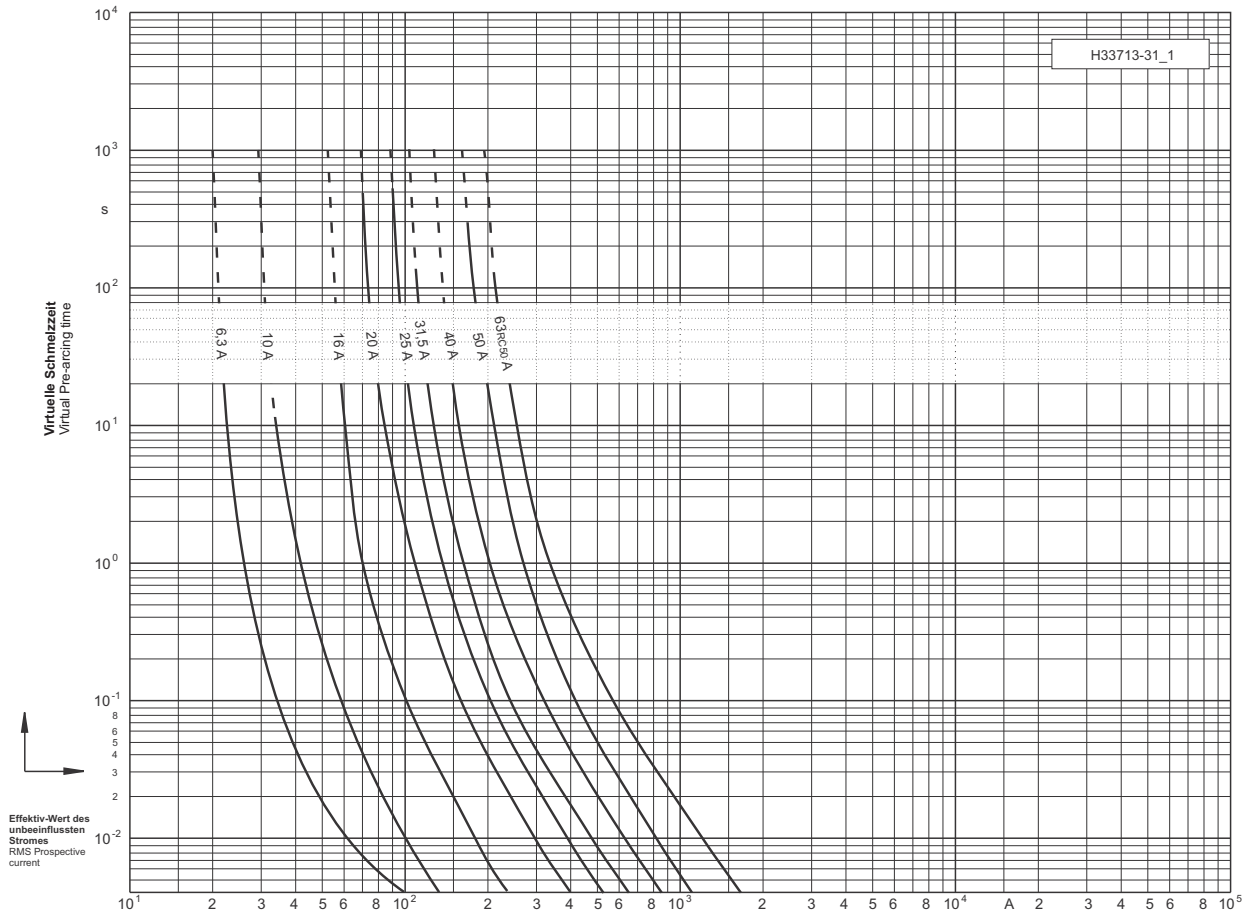

Durchlass-Strom
Cut-off current

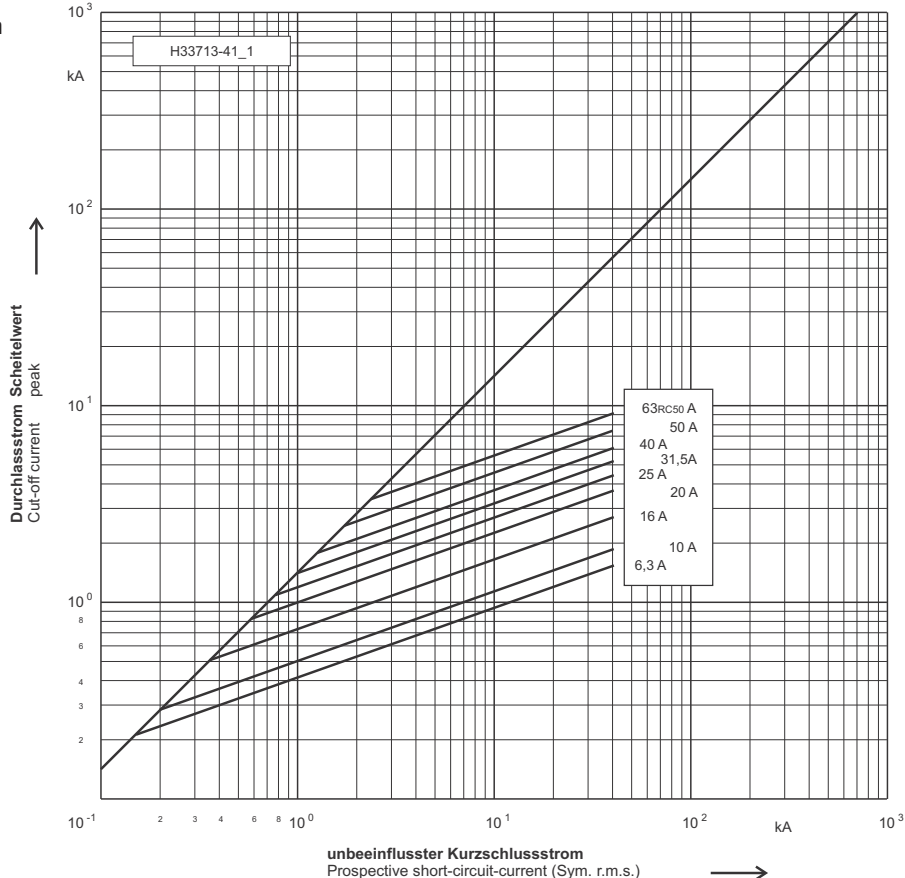

40,5 kV

"e" = 537 mm

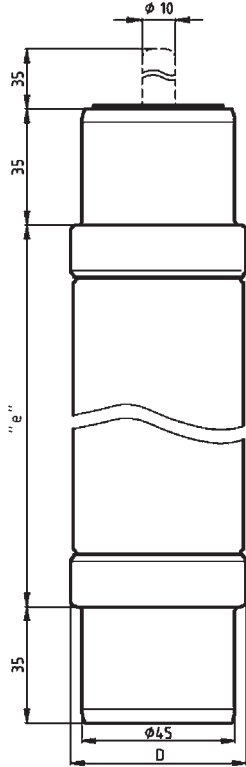

Sonderausführung / Special design

Einsatz / Application

Luft- und gasisolierte Mittelspannungsschaltanlagen / Air and gas insulated switchgear
Für Innen- und Freiluftanwendungen / Indoor and outdoor application

Verpackung / Packing 1 Stück / 1 piece

Betriebsklasse / Class	IEC 60282-1	VDE 0670-4
Teilbereich / Back-up	DIN 43 625	

Bemessungs- spannung Rated Voltage	Artikel Article	Bemessungsstrom Rated Current	Länge "e" Length "e"	Durchmesser D Diameter D
kV		A	mm	mm
40,5	30 340 13	6,3 - 20	537	53
	30 341 13	25 - 40		67
	30 342 13	50RC45 - 63RC50		85

Bemessungs- strom Rated Current	Artikel Nr. Article No.	Gewicht Weight	Bemessungs- Ausschaltstrom Rated Breaking Current - I ₁	Minimaler Ausschaltstrom Min. Breaking Current - I ₃	Schmelzintegral Pre-Arcing I ² t-Value	Ausschaltintegral Total I ² t-Value		Leistungs- abgabe Power Loss	Kaltwider- stand Cold Resistance
						U _n min	U _n max		
A		kg/1	kA	A	A ² s	A ² s	A ² s	W	mΩ
6,3	30 340 13.6,3	2,6	40	22	45	210	360	52	949
10	30 340 13.10	2,6	40	34	75	350	560	81	620
16	30 340 13.16	2,6	40	56	250	1.100	2.000	94	285
20	30 340 13.20	2,6	40	70	640	2.900	4.800	76	145
25	30 341 13.25	3,5	40	90	1.050	4.700	7.500	103	120
31,5	30 341 13.31,5	3,5	40	110	1.700	6.600	12.000	126	98
40	30 341 13.40	3,5	40	140	2.900	12.000	19.000	175	73
50RC45	30 342 13.50	6,0	40	170	5.700	20.000	33.000	176	54
63RC50	30 342 13.63	6,0	40	210	10.700	40.000	66.000	181	39

RC = bitte Seite 13 beachten
please refer to page 13

40,5 kV

"e" = 537 mm

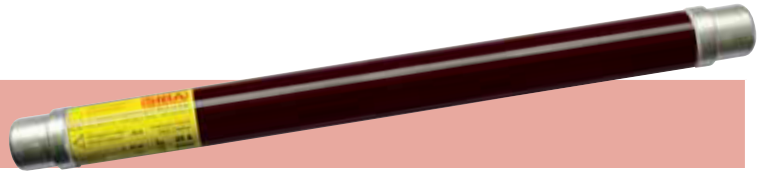

Zeit/Strom-Kennlinie
Time-current characteristic

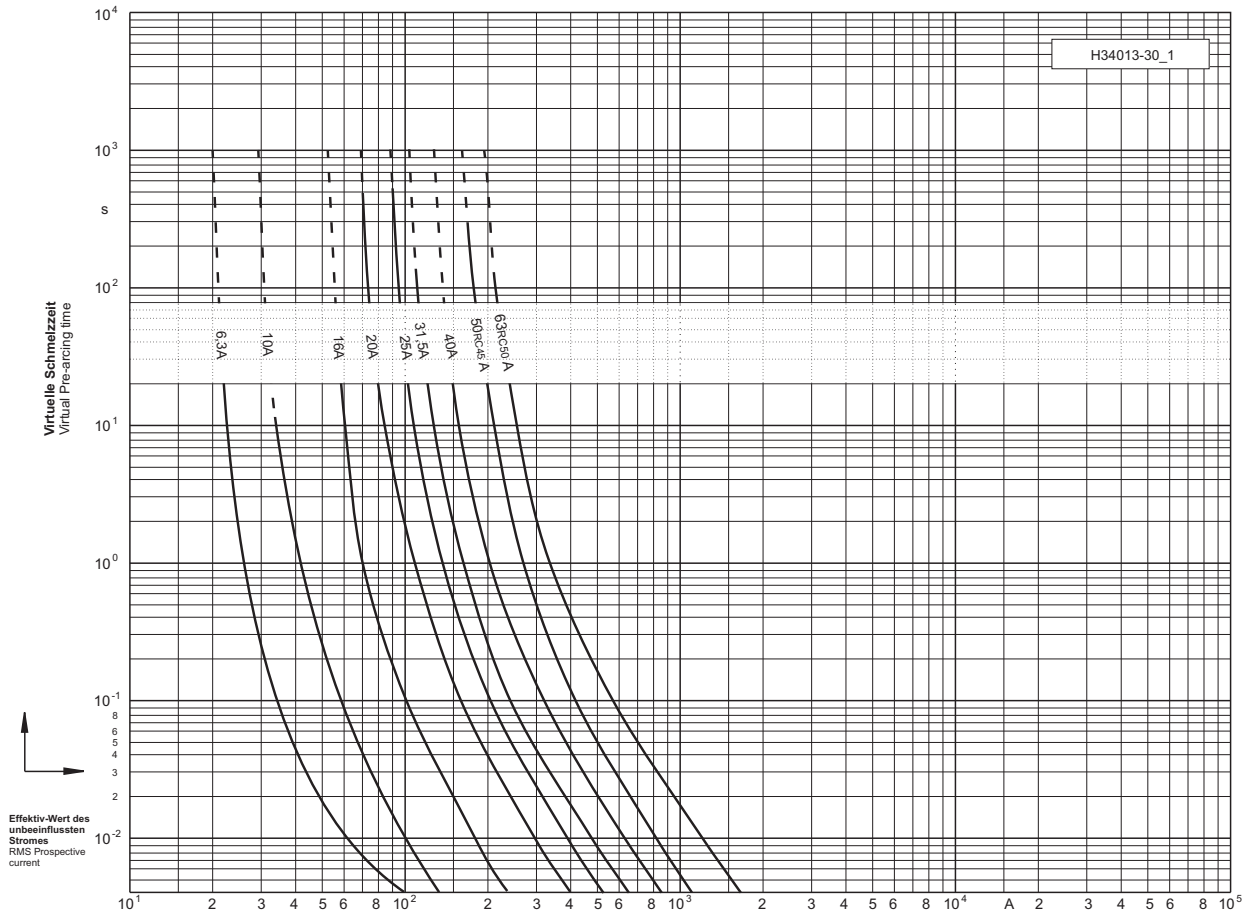

Durchlass-Strom
Cut-off current

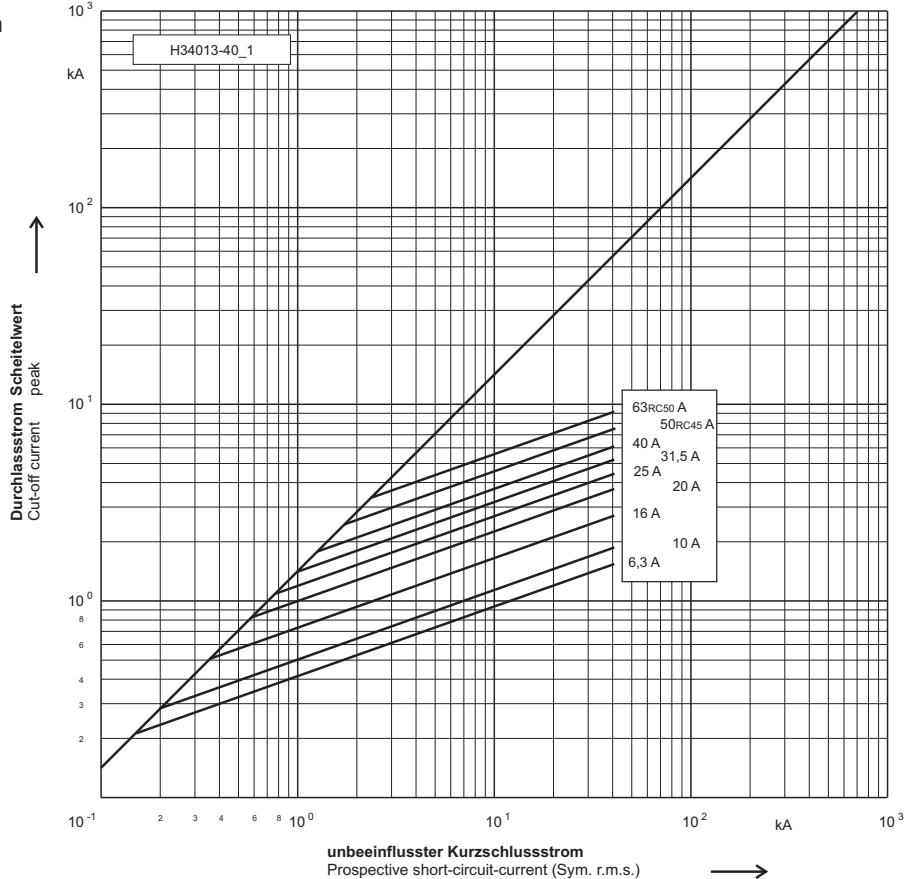

6/12 kV

"e" = 292 mm

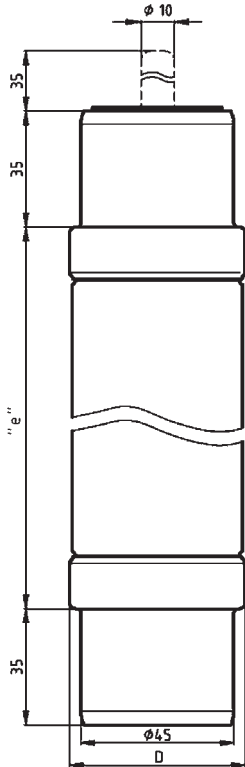

Vorzugsabmessung / Standard dimension

Einsatz / Application

Luft- und gasisolierte Mittelspannungsschaltanlagen / Air and gas insulated switchgear
Für Innen- und Freiluftanwendungen / Indoor and outdoor application

Verpackung / Packing 1 Stück / 1 piece

Betriebsklasse / Class	IEC 60282-1	VDE 0670-4
Teilbereich / Back-up Typ SSK / Type SSK	DIN 43 625	

Bemessungs- spannung Rated Voltage	Artikel Article	Bemessungsstrom Rated Current	Länge "e" Length "e"	Durchmesser D Diameter D
kV		A	mm	mm
6/12	30 012 43	63 - 100	292	67
	30 020 43	125		85

Bemessungs- strom Rated Current	Artikel Nr. Article No.	Gewicht Weight	Bemessungs- ausschaltstrom Rated Breaking Current - I ₁	Minimaler Ausschaltstrom Min. Breaking Current - I ₃	Schmelzintegral Pre-Arcing- I ² t-Value	Ausschaltintegral Total I ² t-Value	Leistungs- abgabe Power Loss	Kaltwider- stand Cold Resistance
A		kg/1	kA	A	A ² s	A ² s	W	mΩ
63	30 012 43.63	2,0	63	210	9.300	74.000	62	10
80	30 012 43.80	2,0	63	280	12.800	103.000	76	8,7
100	30 012 43.100	2,0	63	320	22.300	138.000	98	6,5
125	30 020 43.125	3,8	63	450	39.000	323.000	135	4,8

6/12 kV

"e" = 292 mm



Zeit/Strom-Kennlinie
Time-current characteristic

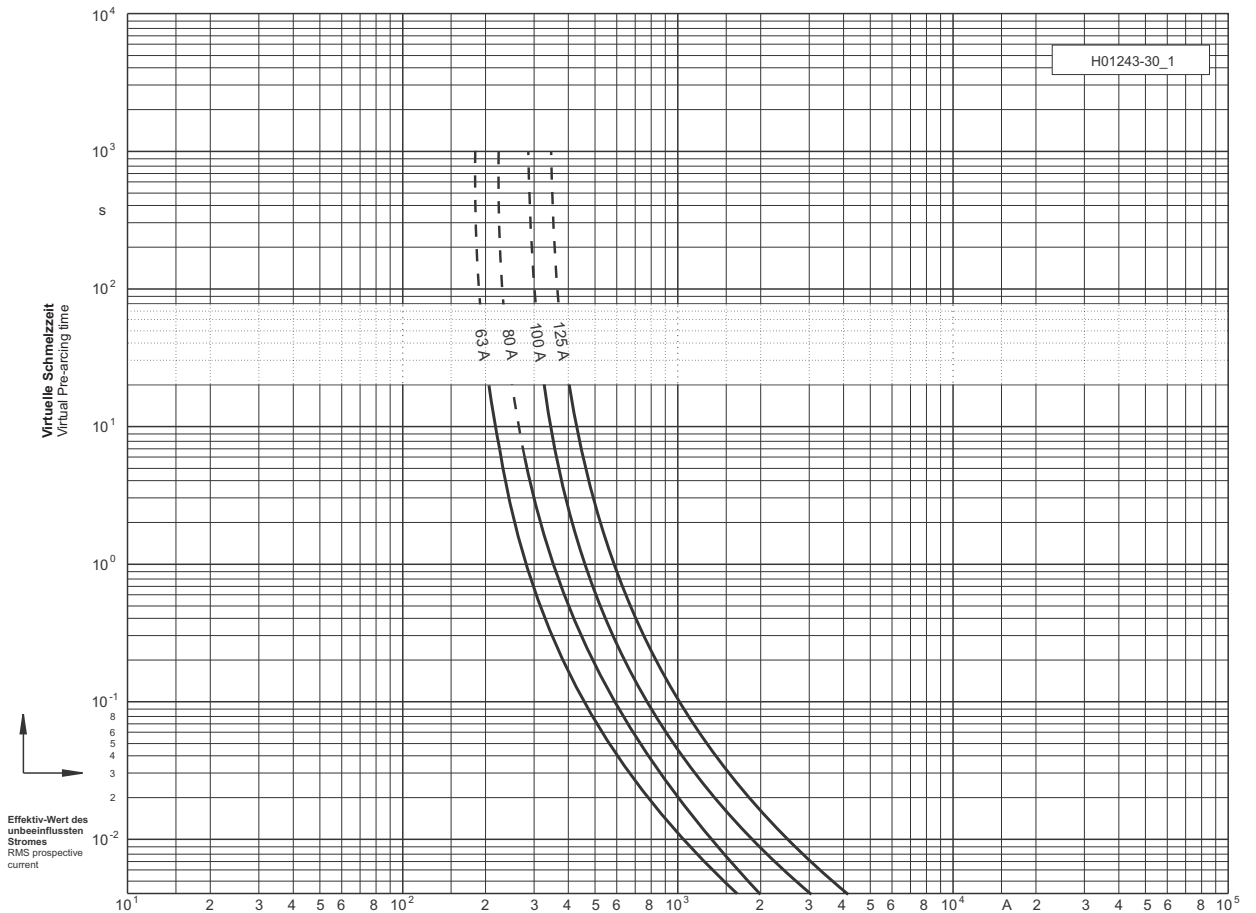

Durchlass-Strom
Cut-off current

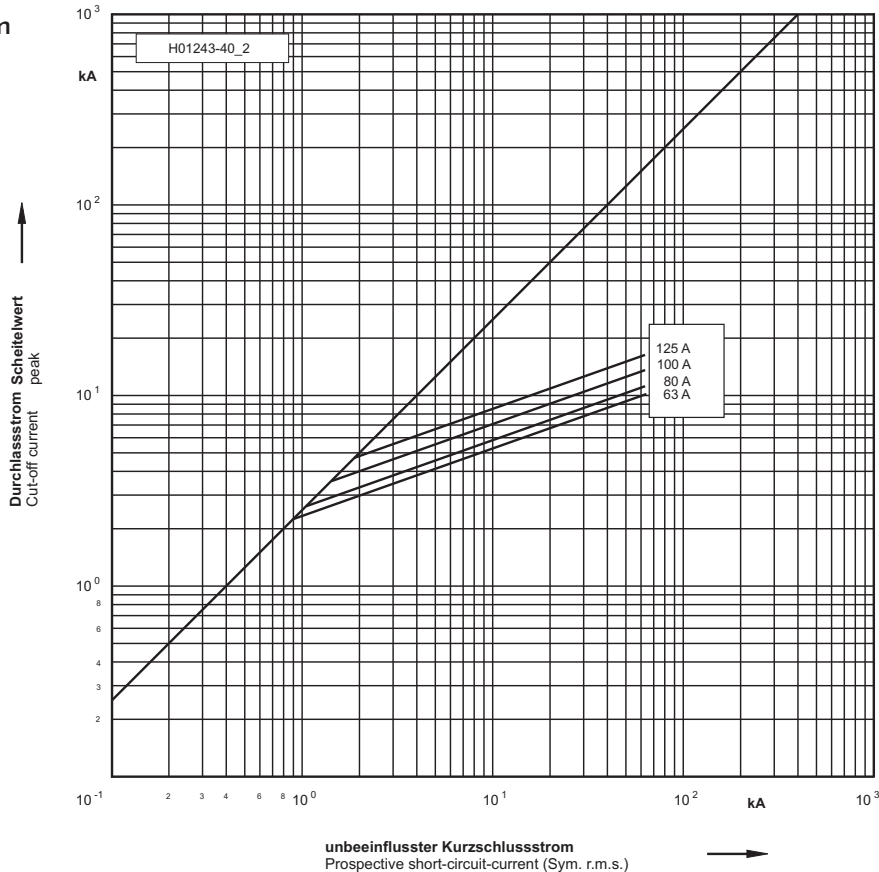

6/12 kV

"e" = 442 mm

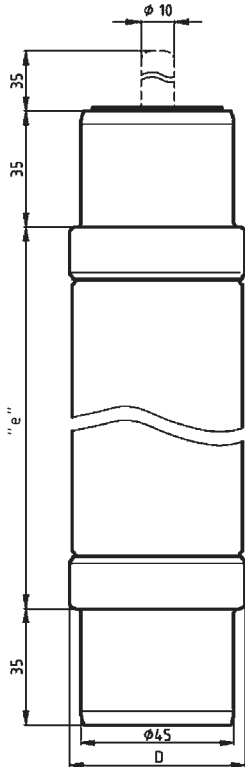
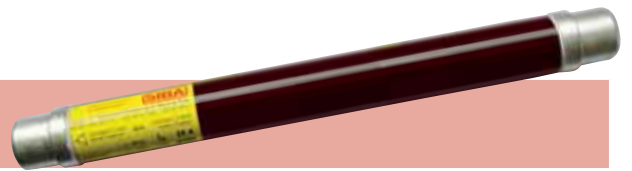

Nebenabmessung / Variant dimension

Einsatz / Application

Luft- und gasisolierte Mittelspannungsschaltanlagen / Air and gas insulated switchgear
Für Innen- und Freiluftanwendungen / Indoor and outdoor application

Verpackung / Packing 1 Stück / 1 piece

Betriebsklasse / Class	IEC 60282-1	VDE 0670-4
Teilbereich / Back-up Typ SSK / Type SSK	DIN 43 625	

Bemessungs- spannung Rated Voltage	Artikel Article	Bemessungsstrom Rated Current	Länge "e" Length "e"	Durchmesser D Diameter D
kV		A	mm	mm
6/12	30 102 43	80 - 100	442	67
	30 103 43	125 - 160RC140		85

Bemessungs- strom Rated Current	Artikel Nr. Article No.	Gewicht Weight	Bemessungs- ausschaltstrom Rated Breaking Current - I ₁	Minimaler Ausschaltstrom Min. Breaking Current - I ₃	Schmelzintegral Pre-Arcing- I ² t-Value	Ausschaltintegral Total I ² t-Value	Leistungs- abgabe Power Loss	Kaltwider- stand Cold Resistance
A		kg/1	kA	A	A ² s	A ² s	W	mΩ
80	30 102 43.80	2,9	63	280	12.800	103.000	72	8,7
100	30 102 43.100	2,9	63	320	22.300	138.000	93	6,5
125	30 103 43.125	5,4	63	450	39.000	323.000	128	4,8
160RC140	30 103 43.160	5,4	63	600	50.000	405.000	125	4,5

RC = bitte Seite 13 beachten
please refer to page 13

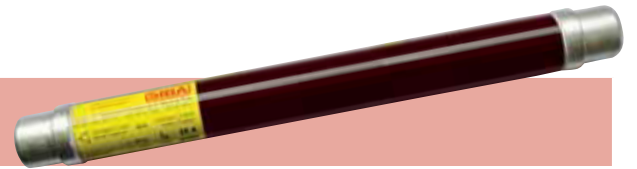

6/12 kV "e" = 442 mm

Zeit/Strom-Kennlinie
Time-current characteristic

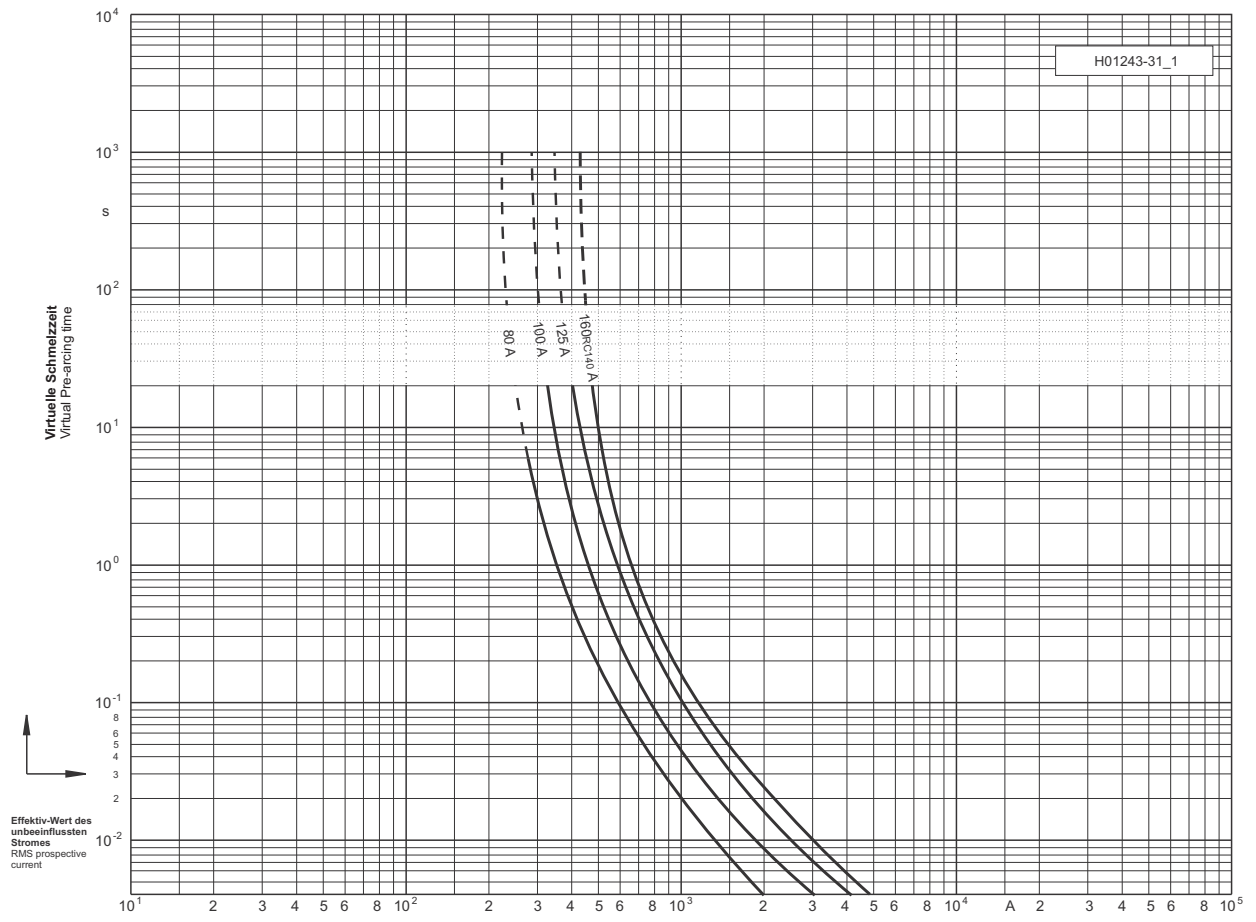

Durchlass-Strom
Cut-off current

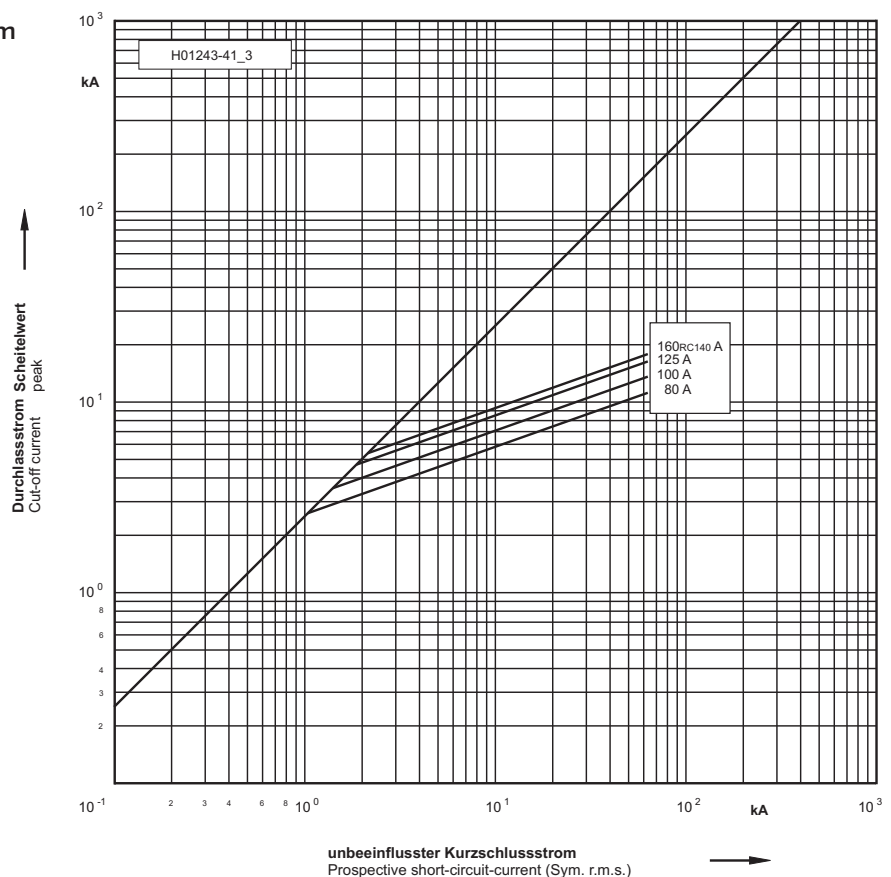

unbeeinflusster Kurzschlussstrom
Prospective short-circuit-current (Sym. r.m.s.)

10/24 kV "e" = 442 mm

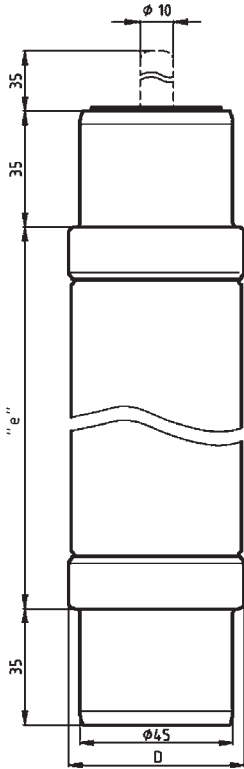
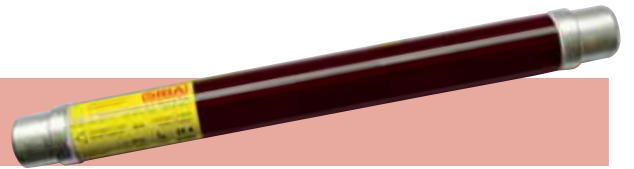

Vorzugsabmessung / Standard dimension

Einsatz / Application

Luft- und gasisolierte Mittelspannungsschaltanlagen / Air and gas insulated switchgear
Für Innen- und Freiluftanwendungen / Indoor and outdoor application

Verpackung / Packing 1 Stück / 1 piece

Betriebsklasse / Class Teilbereich / Back-up Typ SSK / Type SSK	IEC 60282-1 DIN 43 625	VDE 0670-4
---	-----------------------------------	-------------------

Bemessungs- spannung Rated Voltage	Artikel Article	Bemessungsstrom Rated Current	Länge "e" Length "e"	Durchmesser D Diameter D
kV		A	mm	mm
10/24	30 014 43	63 - 80	442	67
	30 022 43	100 - 140RC100		85

Bemessungs- strom Rated Current	Artikel Nr. Article No.	Gewicht Weight	Bemessungs- ausschaltstrom Rated Breaking Current - I ₁	Minimaler Ausschaltstrom Min. Breaking Current - I ₃	Schmelzintegral Pre-Arcing- I ² t-Value	Ausschaltintegral Total I ² t-Value	Leistungs- abgabe Power Loss	Kaltwider- stand Cold Resistance
A		kg/1	kA	A	A ² s	A ² s	W	mΩ
63	30 014 43.63	2,9	63	210	9.300	74.000	117	19
80	30 014 43.80	2,9	63	280	12.800	103.000	143	15
100	30 022 43.100	5,4	63	320	22.300	136.000	188	12
125	30 022 43.125	5,4	63	450	30.300	248.000	277	10
140RC100	30 022 43.140	5,4	63	500	55.000	395.000	116	8

RC = bitte Seite 13 beachten
please refer to page 13

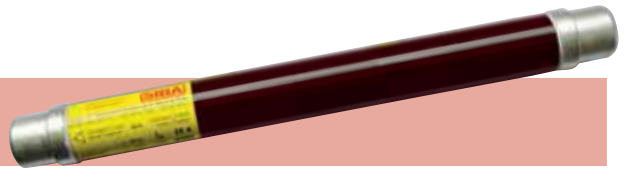

10/24 kV "e" = 442 mm

Zeit/Strom-Kennlinie
Time-current characteristic

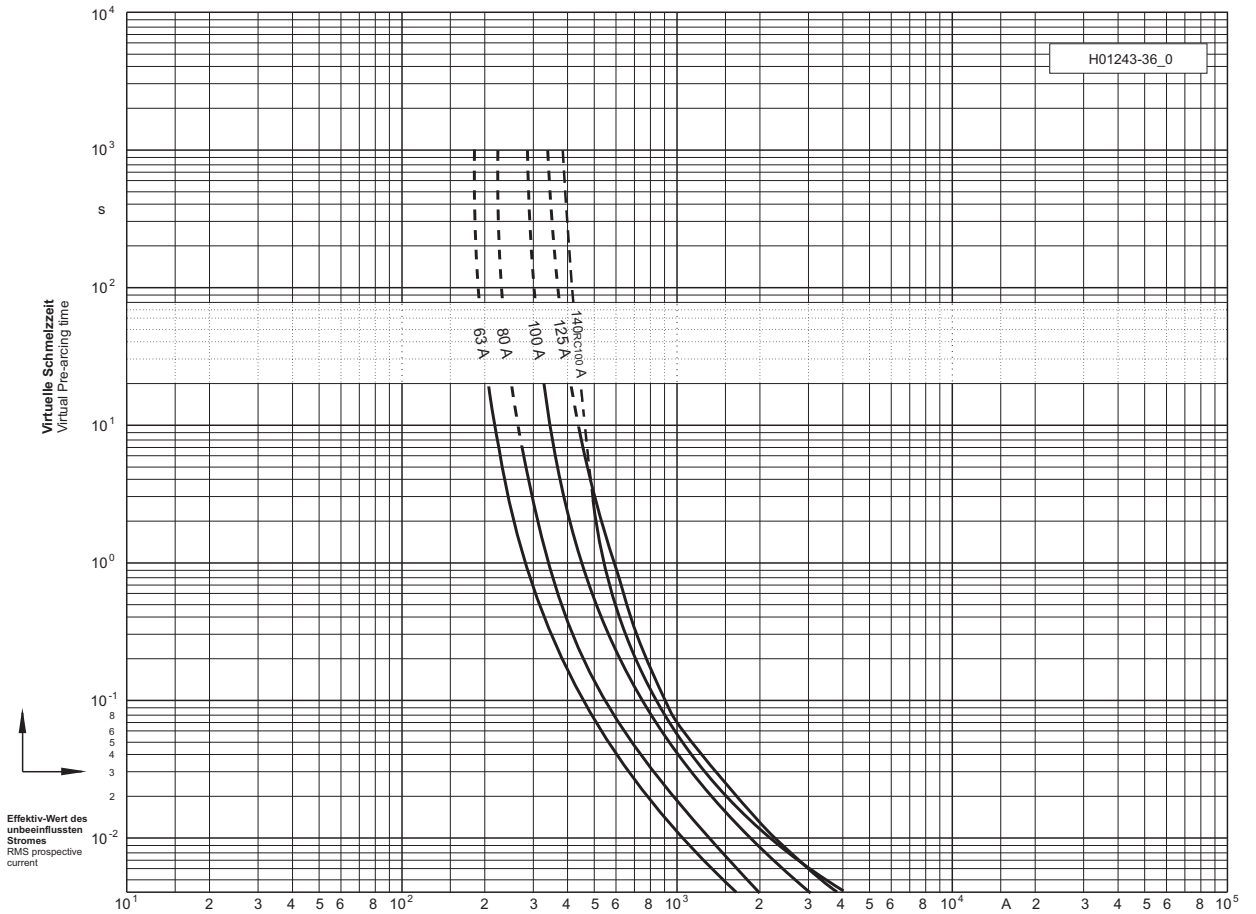

Durchlass-Strom
Cut-off current

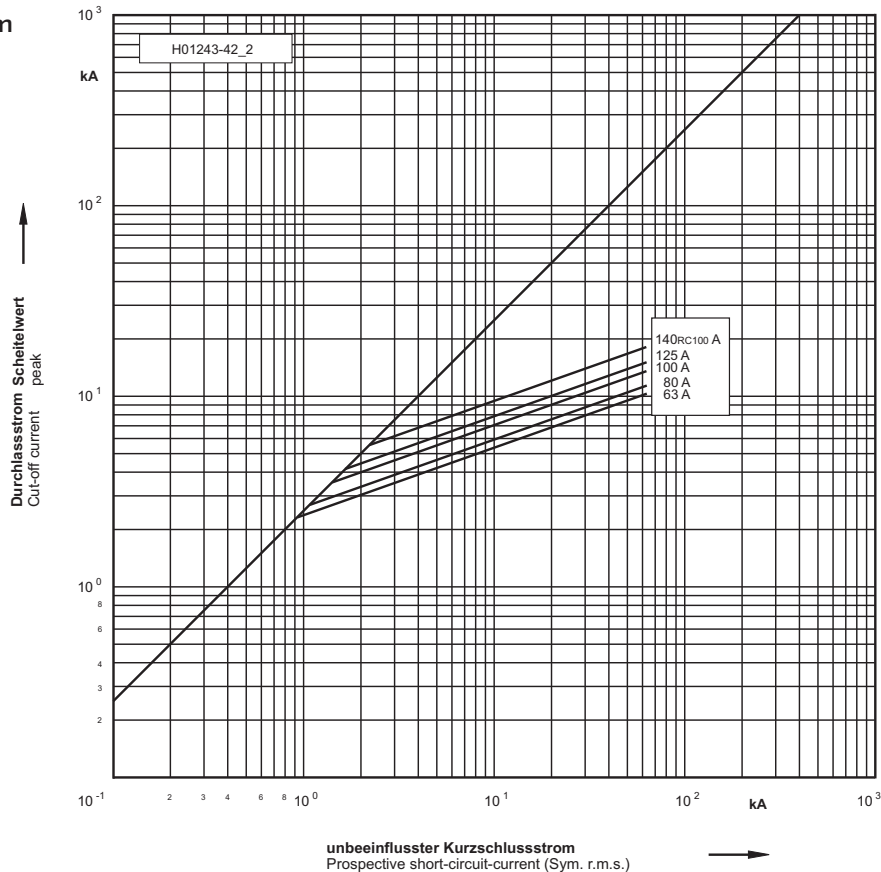

unbeeinflusster Kurzschlussstrom
Prospective short-circuit-current (Sym. r.m.s.)

20/36 kV "e" = 537 mm

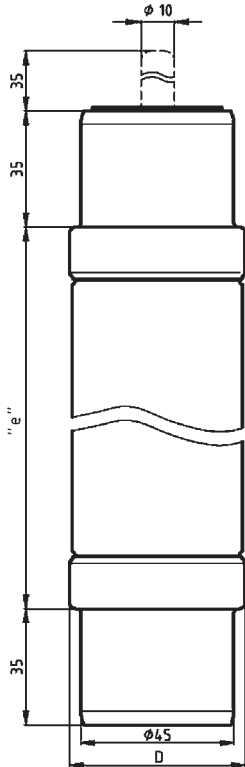
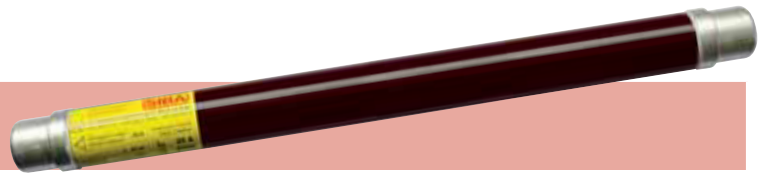

Vorzugsabmessung / Standard dimension

Einsatz / Application

Luft- und gasisolierte Mittelspannungsschaltanlagen / Air and gas insulated switchgear
Für Innen- und Freiluftanwendungen / Indoor and outdoor application

Verpackung / Packing 1 Stück / 1 piece

Betriebsklasse / Class Teilbereich / Back-up Typ SSK / Type SSK	IEC 60282-1 DIN 43 625	VDE 0670-4
---	-----------------------------------	-------------------

Bemessungs- spannung Rated Voltage	Artikel Article	Bemessungsstrom Rated Current	Länge "e" Length "e"	Durchmesser D Diameter D
kV		A	mm	mm
20/36	30 024 43	50 - 80RC71	537	85

Bemessungs- strom Rated Current	Artikel Nr. Article No.	Gewicht Weight	Bemessungs- ausschaltstrom Rated Breaking Current - I ₁	Minimaler Ausschaltstrom Min. Breaking Current - I ₃	Schmelzintegral Pre-Arcing- I ² t-Value	Ausschaltintegral Total I ² t-Value	Leistungs- abgabe Power Loss	Kaltwider- stand Cold Resistance
A		kg/1	kA	A	A ² s	A ² s	W	mΩ
50	30 024 43.50	6,0	40	170	6.200	49.000	132	36
63	30 024 43.63	6,0	40	210	9.300	74.000	189	30
80RC71	30 024 43.80	6,0	40	320	18.400	138.000	153	21

RC = bitte Seite 13 beachten
please refer to page 13

20/36 kV "e" = 537 mm



Zeit/Strom-Kennlinie
Time-current characteristic

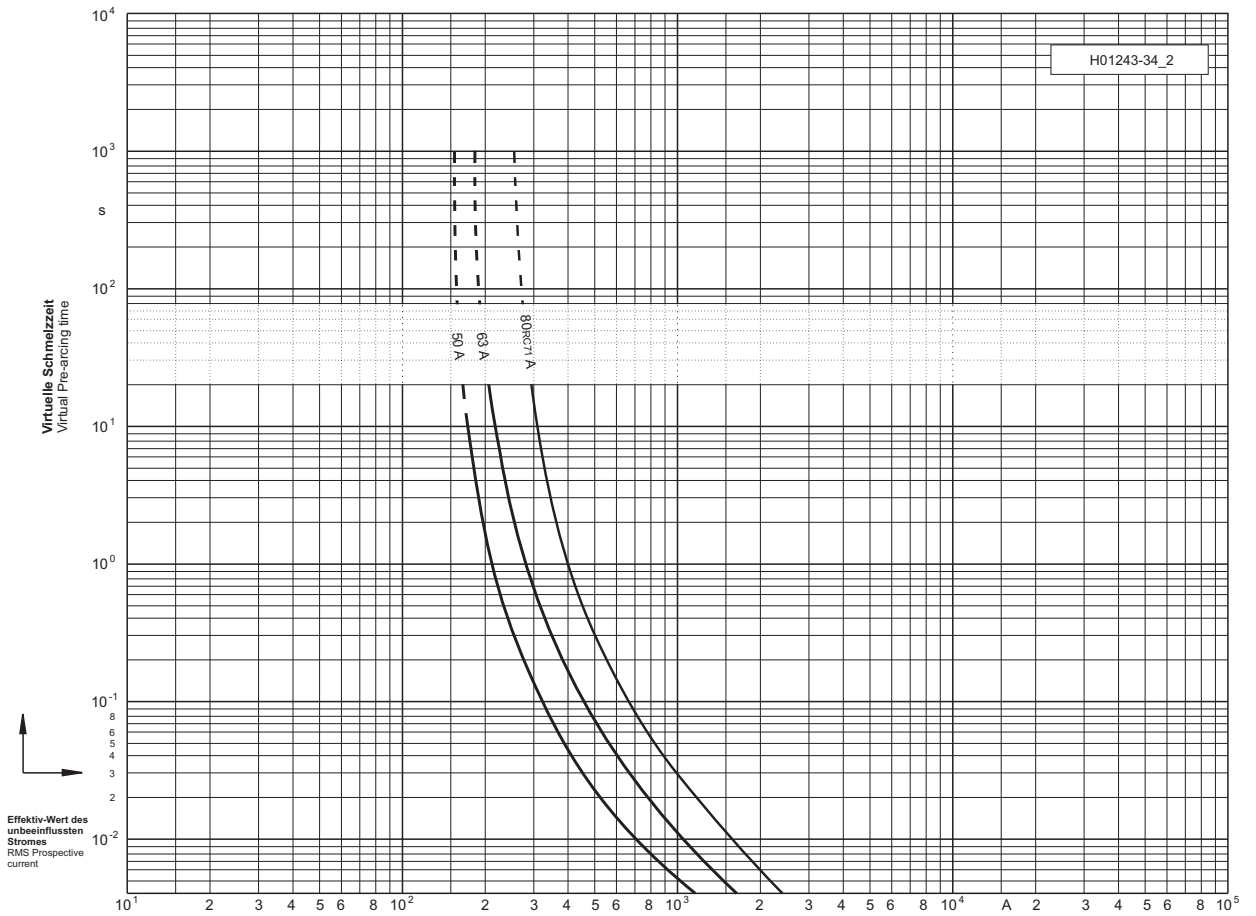

Durchlass-Strom
Cut-off current

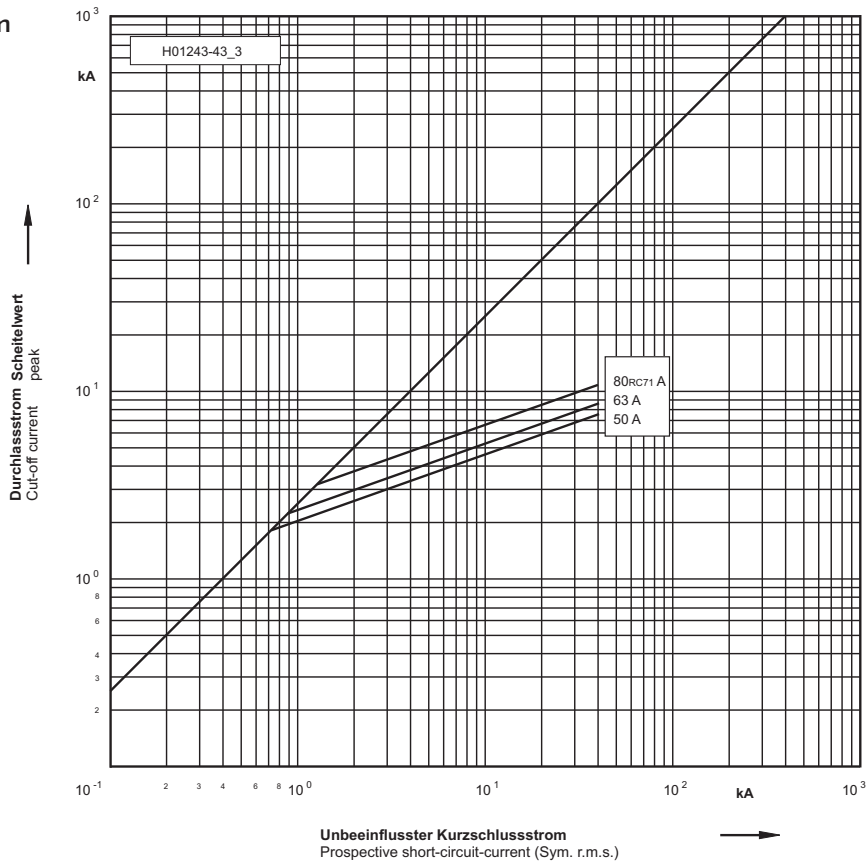

6/12 kV

"e" = 292 mm

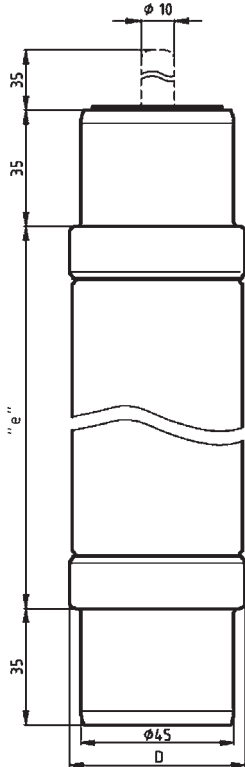

Vorzugsabmessung / Standard dimension

Einsatz / Application

Luft- und gasisolierte Mittelspannungsschaltanlagen / Air and gas insulated switchgear
Für Innen- und Freiluftanwendungen / Indoor and outdoor application

Verpackung / Packing 1 Stück / 1 piece

Betriebsklasse / Class Vielbereich General purpose	IEC 60282-1 DIN 43 625	VDE 0670-4
--	-----------------------------------	-------------------

Bemessungs- spannung Rated Voltage	Artikel Article	Bemessungsstrom Rated Current	Länge "e" Length "e"	Durchmesser D Diameter D
kV		A	mm	mm
6/12	30 004 93	6,3	292	53
	30 012 93	8 - 40		67
	30 020 93	50 - 100		85

Bemessungs- strom Rated Current	Artikel Nr. Article No.	Gewicht Weight	Bemessungs- ausschaltstrom Rated Breaking Current - I ₁	Schmelzintegral Pre-Arcing- I ² t-Value	Ausschaltintegral Total I ² t-Value	Leistungsabgabe Power Loss	Kaltwiderstand Cold Resistance
A		kg/1	kA	A ² s	A ² s	W	mΩ
6,3	30 004 93.6,3	1,6	63	110	900	7	150
8	30 012 93.8	2,0	63	180	1.400	9	120
10	30 012 93.10	2,0	63	240	2.000	12	100
16	30 012 93.16	2,0	63	530	4.400	12	40
20	30 012 93.20	2,0	63	850	7.000	15	31
25	30 012 93.25	2,0	63	1.330	11.000	18	25
31,5	30 012 93.31,5	2,0	63	2.100	18.000	23	20
40	30 012 93.40	2,0	63	3.400	28.000	29	16
50	30 020 93.50	3,8	63	5.500	33.000	42	15
63	30 020 93.63	3,8	63	8.500	68.000	54	12
80	30 020 93.80	3,8	63	16.200	142.000	79	9
100	30 020 93.100	3,8	63	23.500	183.000	108	7,7

6/12 kV

"e" = 292 mm



Zeit/Strom-Kennlinie
Time-current characteristic

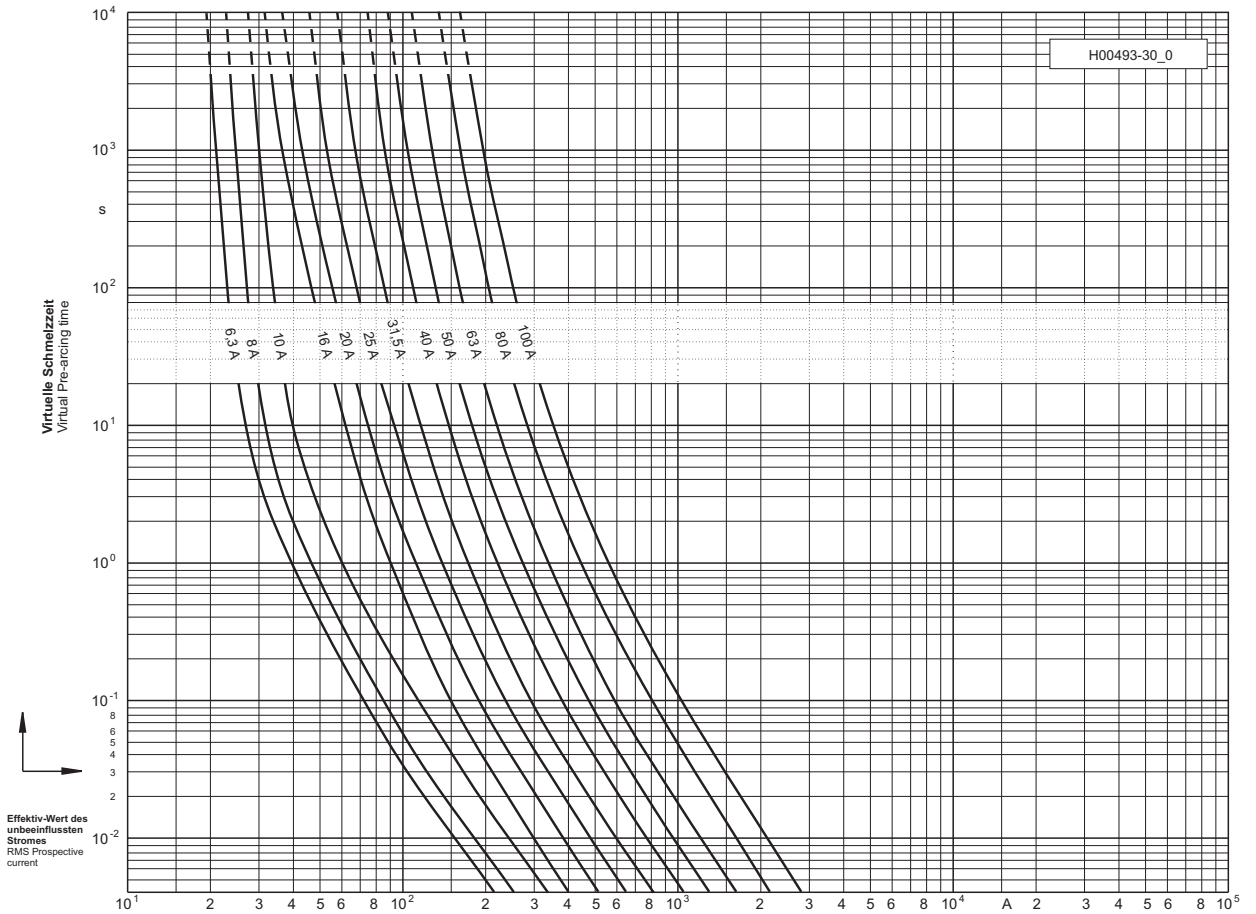

Durchlass-Strom
Cut-off current

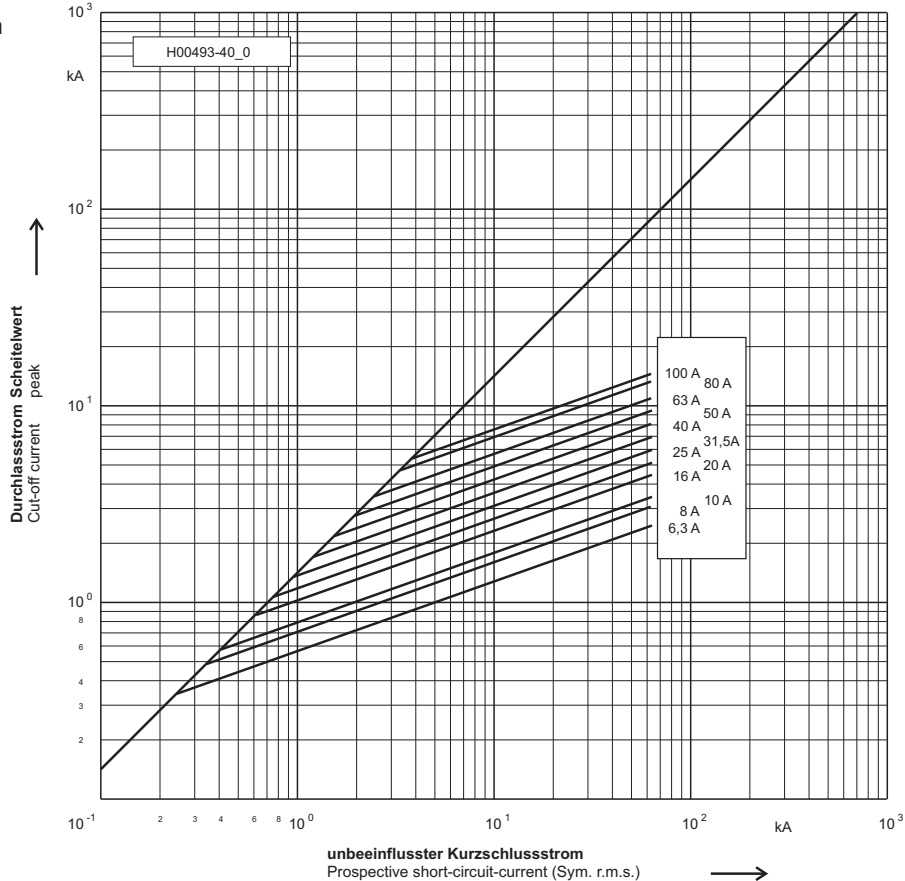

10/24 kV "e" = 442 mm

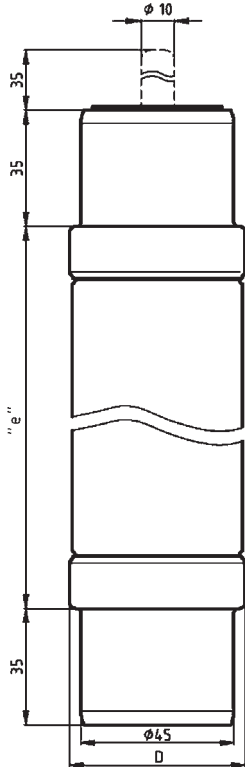
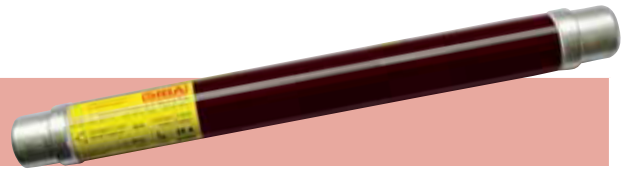

Vorzugsabmessung / Standard dimension

Einsatz / Application

Luft- und gasisolierte Mittelspannungsschaltanlagen / Air and gas insulated switchgear
Für Innen- und Freiluftanwendungen / Indoor and outdoor application

Verpackung / Packing 1 Stück / 1 piece

Betriebsklasse / Class Vielbereich General purpose	IEC 60282-1 DIN 43 625	VDE 0670-4
--	-----------------------------------	-------------------

Bemessungs- spannung Rated Voltage	Artikel Article	Bemessungsstrom Rated Current	Länge "e" Length "e"	Durchmesser D Diameter D
kV		A	mm	mm
10/24	30 006 93	6,3	442	53
	30 014 93	8 - 25		67
	30 022 93	31,5 - 40		85

Bemessungs- strom Rated Current	Artikel Nr. Article No.	Gewicht Weight	Bemessungs- ausschaltstrom Rated Breaking Current - I ₁	Schmelzintegral Pre-Arcing- I ² t-Value	Ausschaltintegral Total I ² t-Value	Leistungsabgabe Power Loss	Kaltwiderstand Cold Resistance
A		kg/1	kA	A ² s	A ² s	W	mΩ
6,3	30 006 93.6,3	2,2	40	110	900	13	273
8	30 014 93.8	2,9	40	180	1.400	17	220
10	30 014 93.10	2,9	40	240	2.000	22	180
16	30 014 93.16	2,9	40	530	4.400	19	70
20	30 014 93.20	2,9	40	850	7.000	27	55
25	30 014 93.25	2,9	40	1.330	11.000	38	45
31,5	30 022 93.31,5	5,4	40	2.100	18.000	54	41
40	30 022 93.40	5,4	40	3.400	28.000	77	33

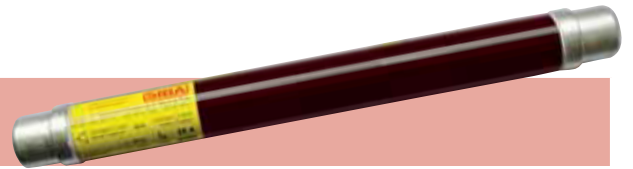

10/24 kV "e" = 442 mm

Zeit/Strom-Kennlinie
Time-current characteristic

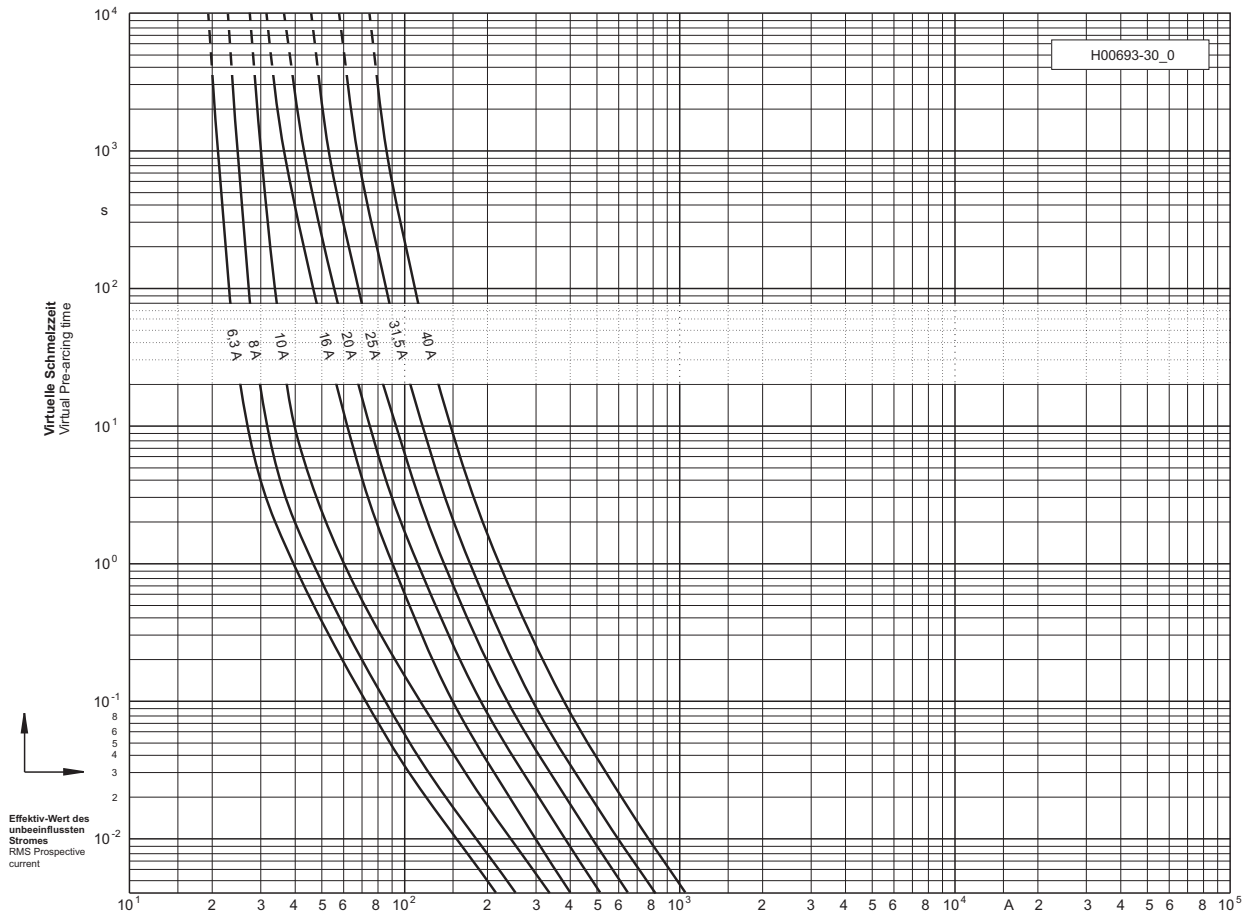

Durchlass-Strom
Cut-off current

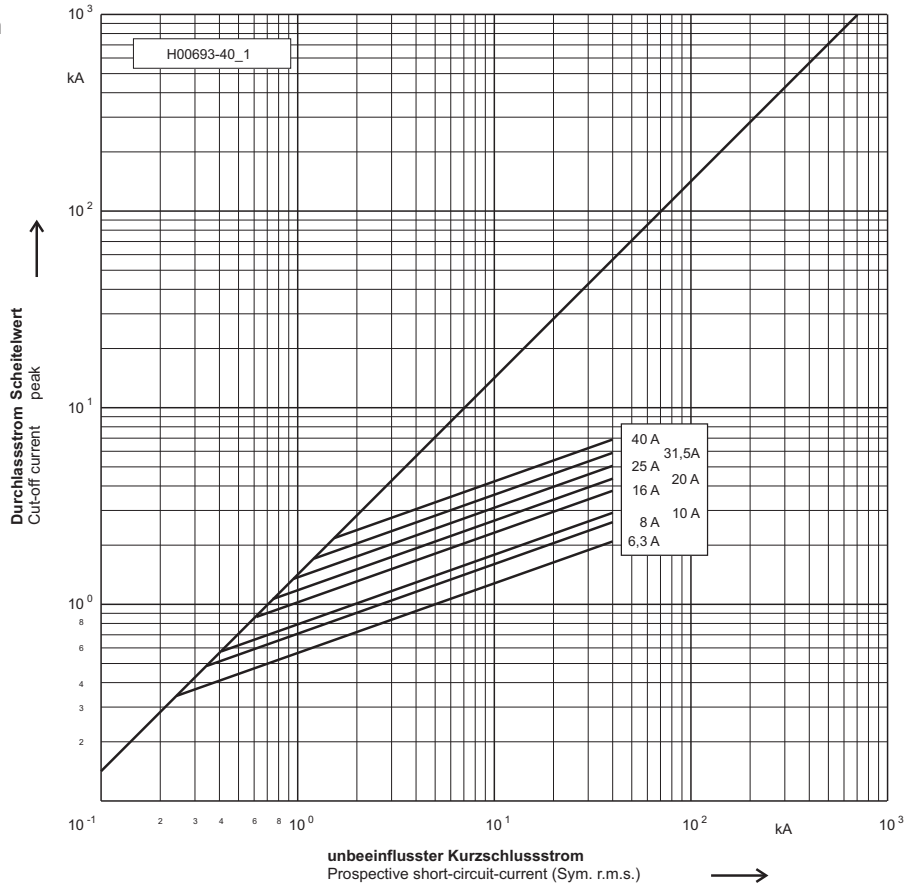

6/12 kV

"e" = 292 mm

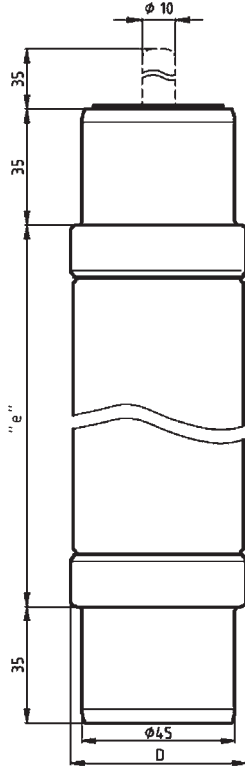

Vorzugsabmessung / Standard dimension

Einsatz / Application

Für Innen- und Freiluftanwendungen / Indoor and outdoor application

Verpackung / Packing 1-2 Stück / 1-2 pieces

Betriebsklasse / Class Ganzbereich Full-range	IEC 60282-1 DIN 43 625	VDE 0670-4
---	-----------------------------------	-------------------

Bemessungs- spannung Rated Voltage	Artikel Article	Bemessungsstrom Rated Current	Länge "e" Length "e"	Durchmesser D Diameter D
kV		A	mm	mm
6/12	30 004 03	6,3 - 40	292	53
	30 012 03	50 - 63		67
	30 020 03	80 - 100		85

Bemessungs- strom Rated Current	Artikel Nr. Article No.	Gewicht Weight	Bemessungs- ausschaltstrom Rated Breaking Current - I ₁	Minimaler Ausschaltstrom Min. Breaking Current - I ₃	Schmelzintegral Pre-Arcing- I ² t-Value	Ausschalt- integral Total I ² t-Value	Leistungs- abgabe Power Loss	Kaltwiderstand Cold Resistance
A		kg/1	kA	A	A ² s	A ² s	W	mΩ
6,3	30 004 03.6,3	1,6	80	6,3	32	480	18	370
10	30 004 03.10	1,6	80	10	130	1.700	29	200
16	30 004 03.16	1,6	80	16	390	1.900	25	70
20	30 004 03.20	1,6	80	20	800	3.500	27	48
25	30 004 03.25	1,6	80	25	1.550	6.500	31	36
31,5	30 004 03.31,5	1,6	80	31,5	2.900	12.000	34	26
40	30 004 03.40	1,6	80	40	5.800	26.500	43	18
50	30 012 03.50	2,6	80	50	9.200	41.000	52	14
63	30 012 03.63	2,6	80	63	15.000	61.500	64	11
80	30 020 03.80	3,9	80	80	31.000	145.000	68	7,7
100	30 020 03.100	3,9	80	100	61.000	260.000	86	5,8

6/12 kV

"e" = 292 mm



Zeit/Strom-Kennlinie
Time-current characteristic

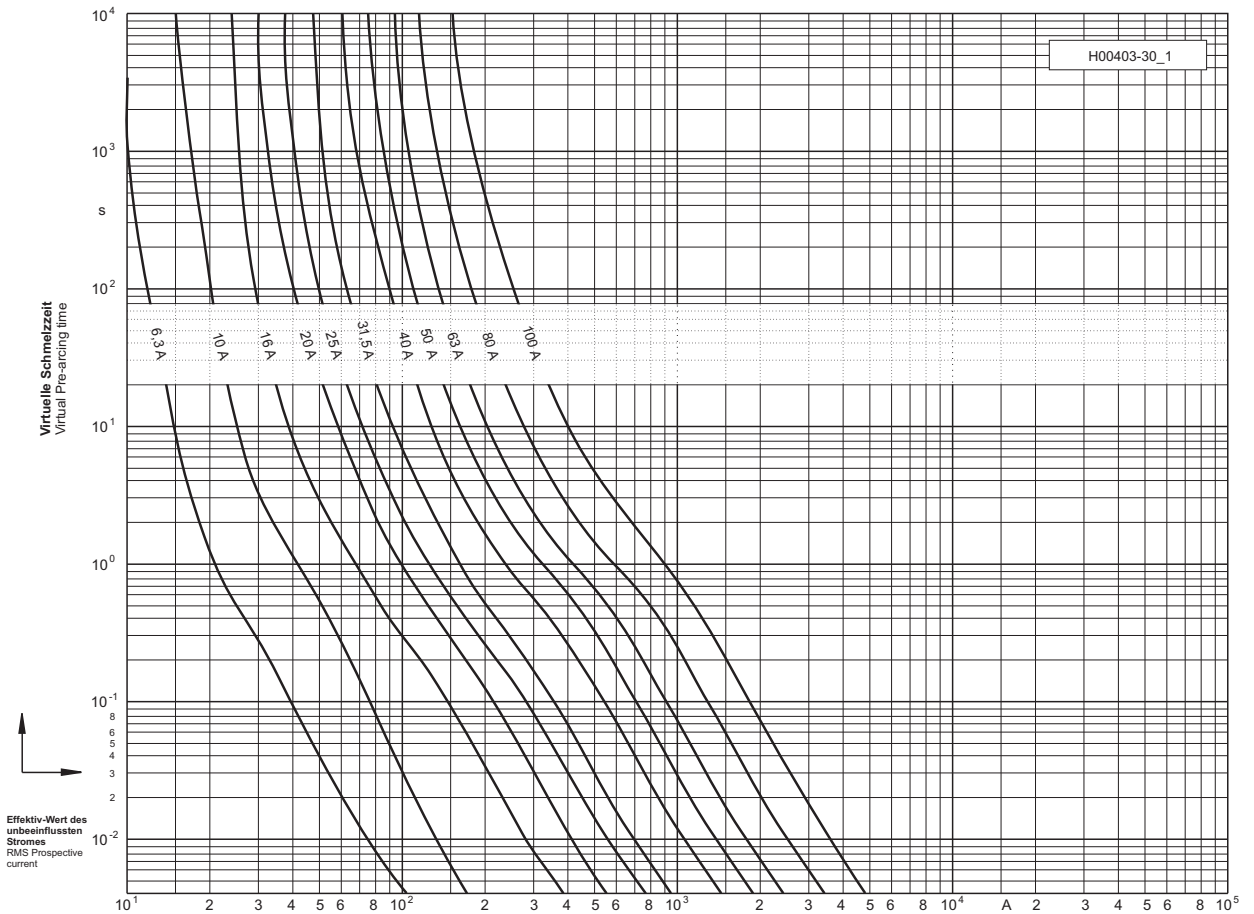

Durchlass-Strom
Cut-off current

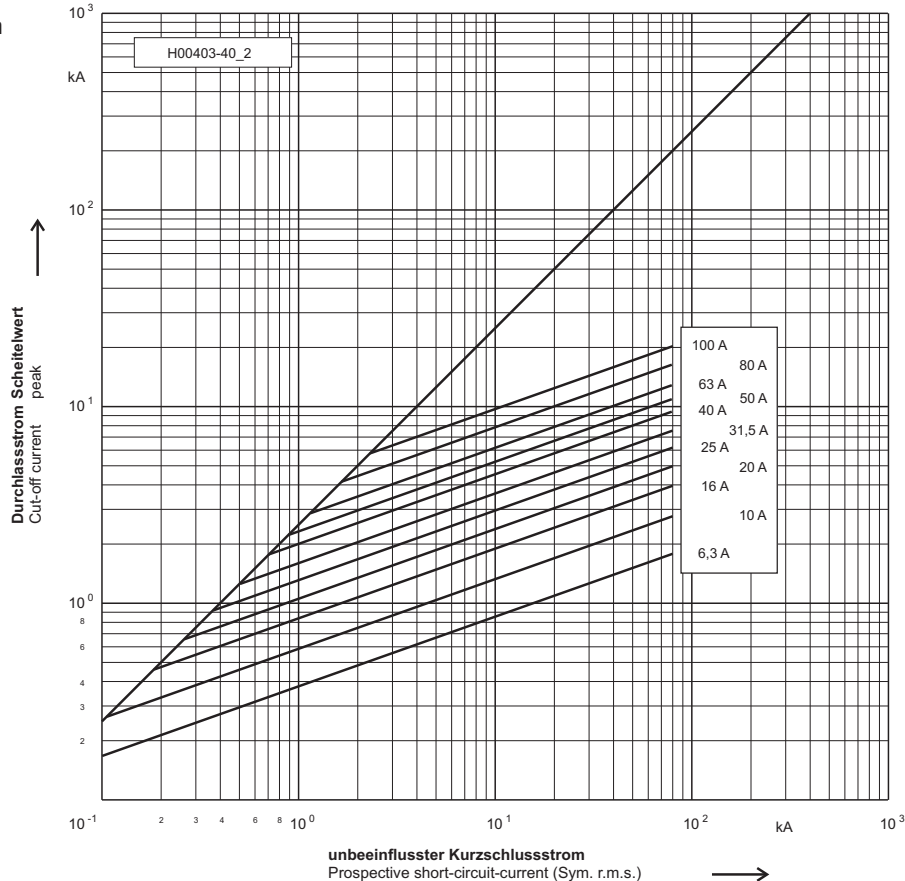

10/24 kV "e" = 442 mm

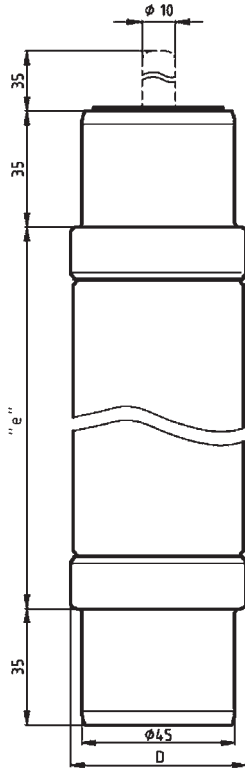

Vorzugsabmessung / Standard dimension

Einsatz / Application

Für Innen- und Freiluftanwendungen / Indoor and outdoor application

Verpackung / Packing 1-2 Stück / 1-2 pieces

Betriebsklasse / Class Ganzbereich Full-range	IEC 60282-1 DIN 43 625	VDE 0670-4
---	-----------------------------------	-------------------

Bemessungs- spannung Rated Voltage	Artikel Article	Bemessungsstrom Rated Current	Länge "e" Length "e"	Durchmesser D Diameter D
kV		A	mm	mm
10/24	30 006 03	6,3 - 31,5	442	53
	30 014 03	40 - 50		67

Bemessungs- strom Rated Current	Artikel Nr. Article No.	Gewicht Weight	Bemessungs- ausschaltstrom Rated Breaking Current - I_1	Minimaler Ausschaltstrom Min. Breaking Current - I_3	Schmelzintegral Pre-Arcing- I^2t -Value	Ausschalt- integral Total I^2t -Value	Leistungs- abgabe Power Loss	Kaltwiderstand Cold Resistance
A		kg/1	kA	A	A^2s	A^2s	W	m Ω
6,3	30 006 03.6,3	2,3	63	6,3	32	470	32	580
10	30 006 03.10	2,3	63	10	85	420	39	280
16	30 006 03.16	2,3	63	16	330	1.600	48	139
20	30 006 03.20	2,3	63	20	800	3.700	50	90
25	30 006 03.25	2,3	63	25	1.600	8.000	57	64
31,5	30 006 03.31,5	2,3	63	31,5	3.200	16.000	65	45
40	30 014 03.40	3,7	63	40	5.800	29.500	82	34
50	30 014 03.50	3,7	63	50	8.700	45.000	105	27

10/24 kV "e" = 442 mm



Zeit/Strom-Kennlinie
Time-current characteristic

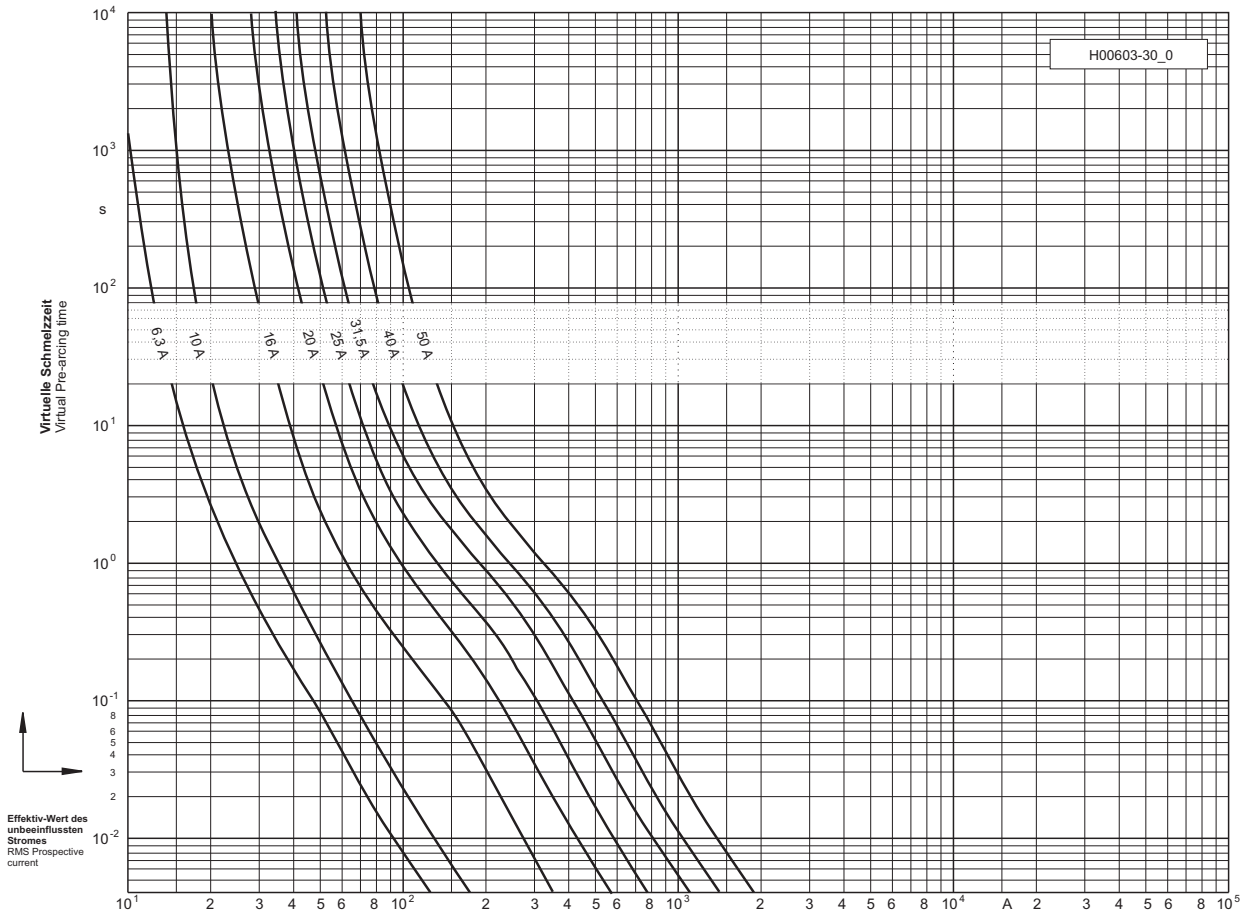

Durchlass-Strom
Cut-off current

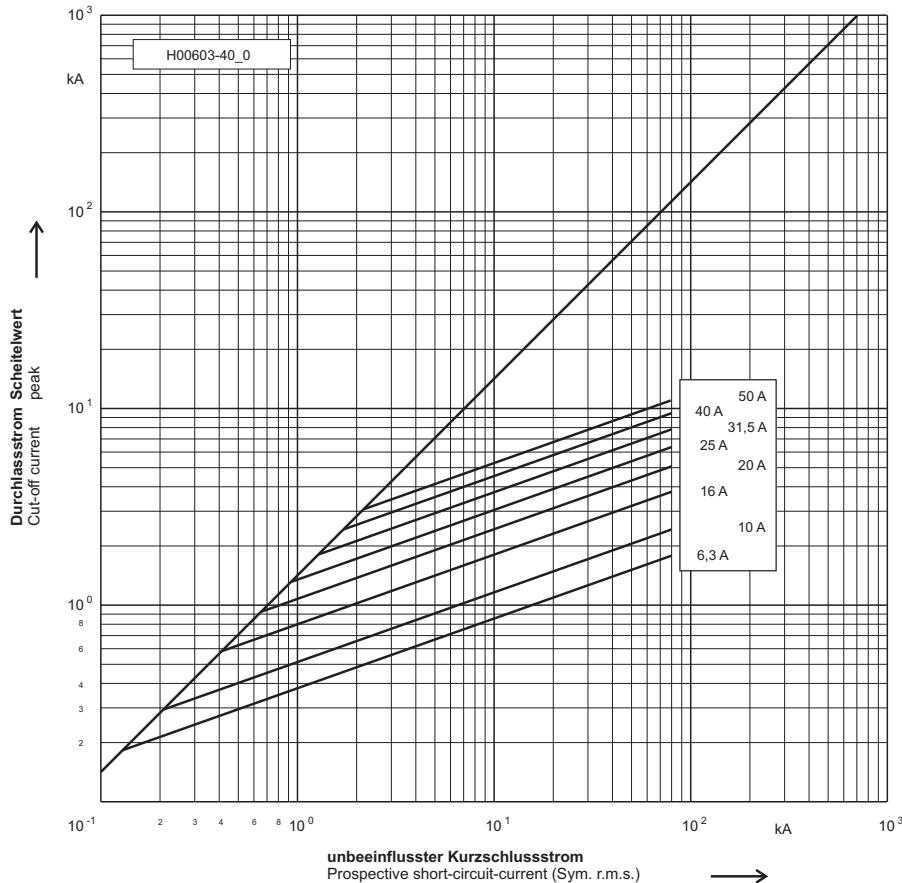

3/3,6 kV "e" = 292 mm

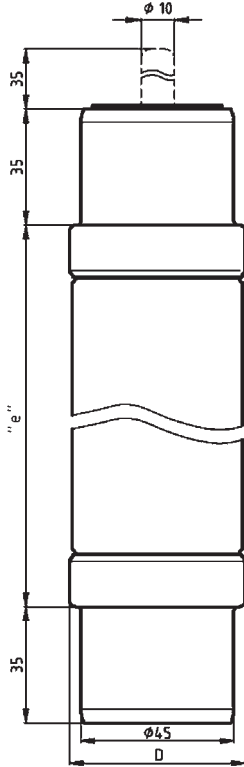

Einsatz / Application

Für Innen- und Freiluftanwendungen / Indoor and outdoor application

Verpackung / Packing 1-2 Stück / 1-2 pieces

Betriebsklasse / Class	IEC 60282-1	VDE 0670-4
Teilbereich / Back-up	DIN 43 625	IEC 60644

Bemessungs- spannung Rated Voltage	Artikel Article	Bemessungsstrom Rated Current	Länge "e" Length "e"	Durchmesser D Diameter D	Anzahl Siche- rungen Number of Barrels
kV		A	mm	mm	
3/3,6	30 201 53	50 - 100	292	53	1
	30 202 53	125 - 160		67	1
	30 200 54	200 - 315		85	1
	30 205 54	355 - 450		85	2

Bemessungsstrom Rated Current	Artikel Nr. Article No.	Gewicht Weight	Bemessungs- ausschaltstrom Rated Breaking Current - I ₁	Minimaler Ausschaltstrom Min. Breaking Current - I ₃	Schmelzintegral Pre-Arcing-I ² t-Value	Ausschalt- integral Total I ² t-Value	Leistungs- abgabe Power Loss
A		kg/1	kA	A	A ² s	A ² s	W
50	30 201 53.50	1,6	50	140	3.400	11.000	27
63	30 201 53.63	1,6	50	165	5.400	17.000	38
80	30 201 53.80	1,6	50	200	6.200	20.000	44
100	30 201 53.100	1,6	50	285	14.000	44.000	47
125	30 202 53.125	2,0	50	375	25.000	78.000	51
160	30 202 53.160	2,0	50	490	64.000	199.000	53
200	30 200 54.200	3,8	50	690	121.000	376.000	58
224	30 200 54.224	3,8	50	790	144.000	448.000	61
250	30 200 54.250	3,8	50	1.050	307.000	952.000	64
315	30 200 54.315	3,8	50	1.260	615.000	1.500.000	75
355	30 205 54.355	7,6	50	2.130	760.000	2.360.000	82
400	30 205 54.400	7,6	50	2.400	1.060.000	3.290.000	87
450	30 205 54.450	7,6	50	2.700	1.230.000	3.800.000	92

3/3,6 kV

"e" = 292 mm



Zeit/Strom-Kennlinie
Time-current characteristic

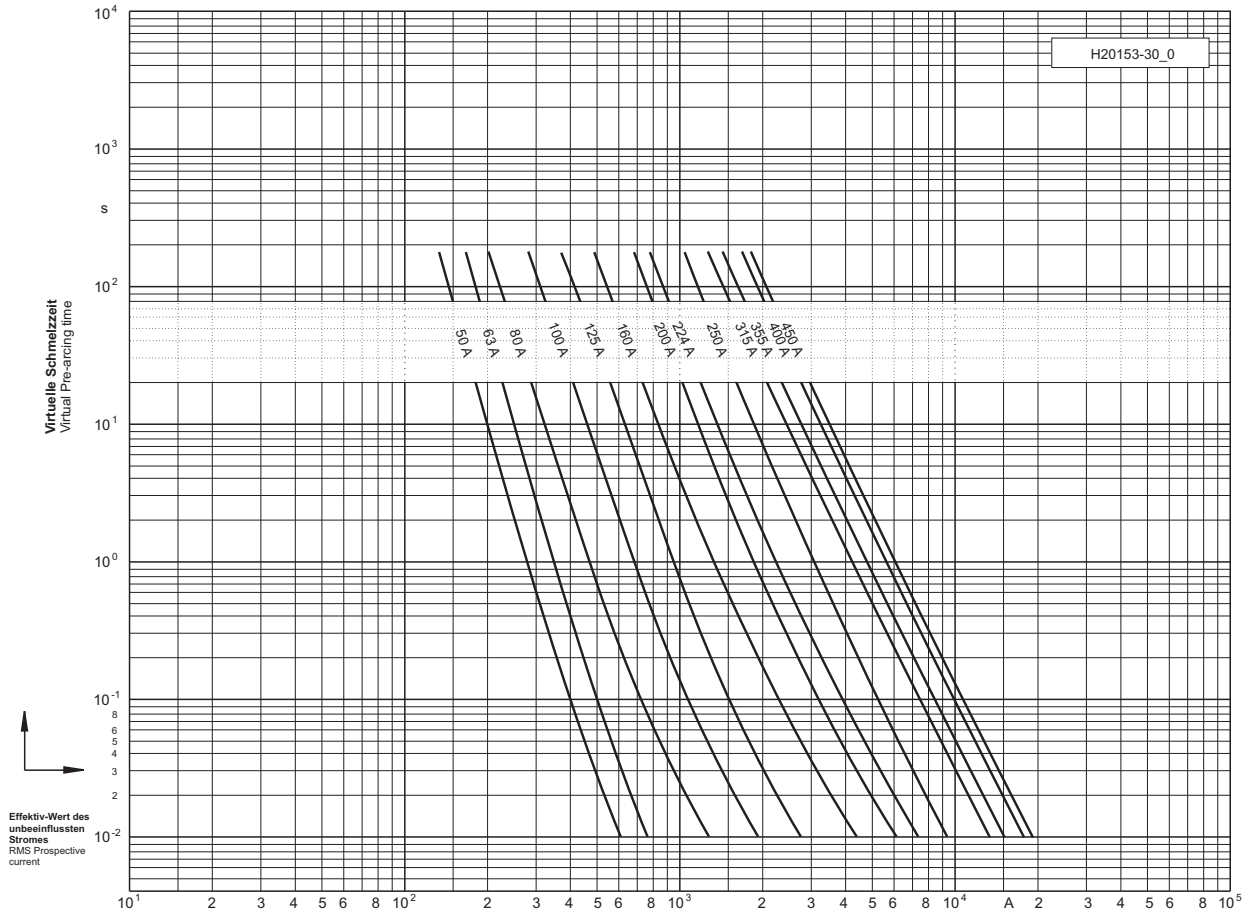

Durchlass-Strom
Cut-off current

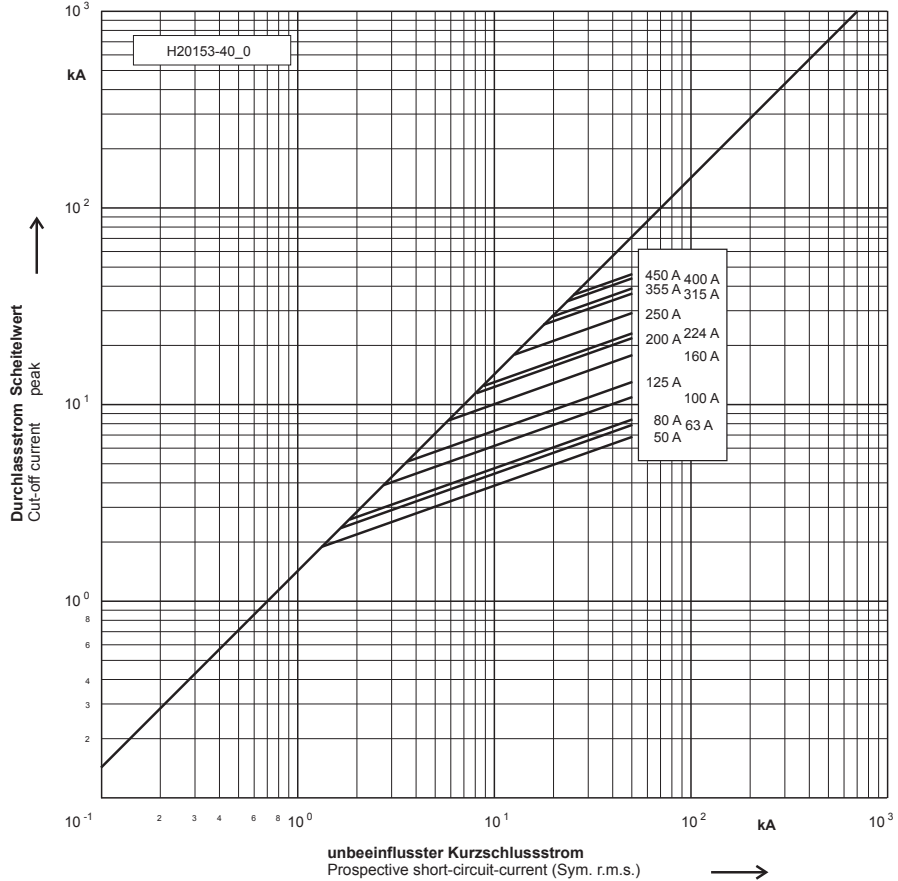

3/7,2 kV "e" = 442 mm

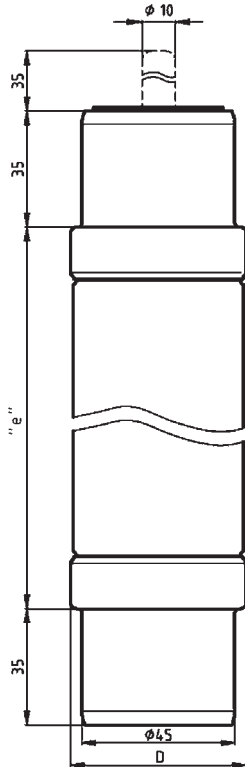
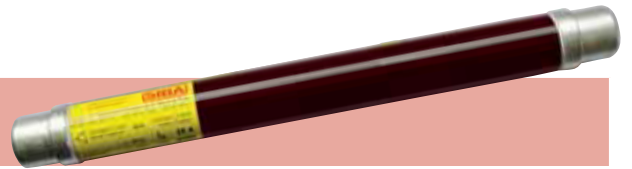

Einsatz / Application

Für Innen- und Freiluftanwendungen / Indoor and outdoor application

Verpackung / Packing 1-2 Stück / 1-2 pieces

Betriebsklasse / Class	IEC 60282-1	VDE 0670-4
Teilbereich / Back-up	DIN 43 625	IEC 60644

Bemessungs- spannung Rated Voltage	Artikel Article	Bemessungsstrom Rated Current	Länge "e" Length "e"	Durchmesser D Diameter D	Anzahl Siche- rungen Number of Barrels
kV		A	mm	mm	
3/7,2	30 108 53	50 - 100	442	53	1
	30 109 53	125 - 160		67	1
	30 110 54	200 - 315		85	1
	30 111 54	355 - 450		85	2

Bemessungs- strom Rated Current	Artikel Nr. Article No.	Gewicht Weight	Bemessungs- ausschaltstrom Rated Breaking Current - I ₁	Minimaler Ausschaltstrom Min. Breaking Current - I ₃	Schmelzintegral Pre-Arcing-I ² t- Value	Ausschalt- integral Total I ² t-Value	Leistungs- abgabe Power Loss	Kaltwiderstand Cold resistance
A		kg/1	kA	A	A ² s	A ² s	W	mΩ
50	30 108 53.50	2,2	50	140	3.400	16.000	23	13
63	30 108 53.63	2,2	50	165	5.400	25.000	49	10
80	30 108 53.80	2,2	50	200	6.200	29.000	72	8,5
100	30 108 53.100	2,2	50	285	14.000	65.000	74	5,6
125	30 109 53.125	2,9	50	375	25.000	115.000	81	4,3
160	30 109 53.160	2,9	50	490	64.000	295.000	91	2,7
200	30 110 54.200	5,4	50	690	121.000	559.000	89	1,9
224	30 110 54.224	5,4	50	790	144.000	694.000	103	1,7
250	30 110 54.250	5,4	50	1.050	307.000	1.480.000	98	1,2
315	30 110 54.315	5,4	50	1.260	627.000	3.000.000	120	0,84
355	30 111 54.355	10,8	50	2.130	759.000	3.700.000	131	0,75
400	30 111 54.400	10,8	50	2.400	903.000	4.400.000	150	0,69
450	30 111 54.450	10,8	50	2.700	1.230.000	5.950.000	163	0,59

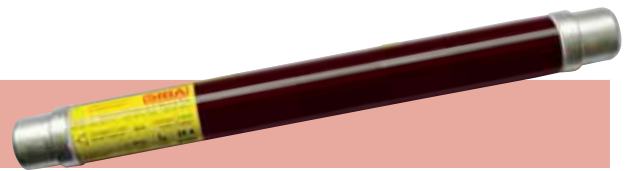

3/7,2 kV

"e" = 442 mm

**Zeit/Strom-
Kennlinie**
Time-current
characteristic

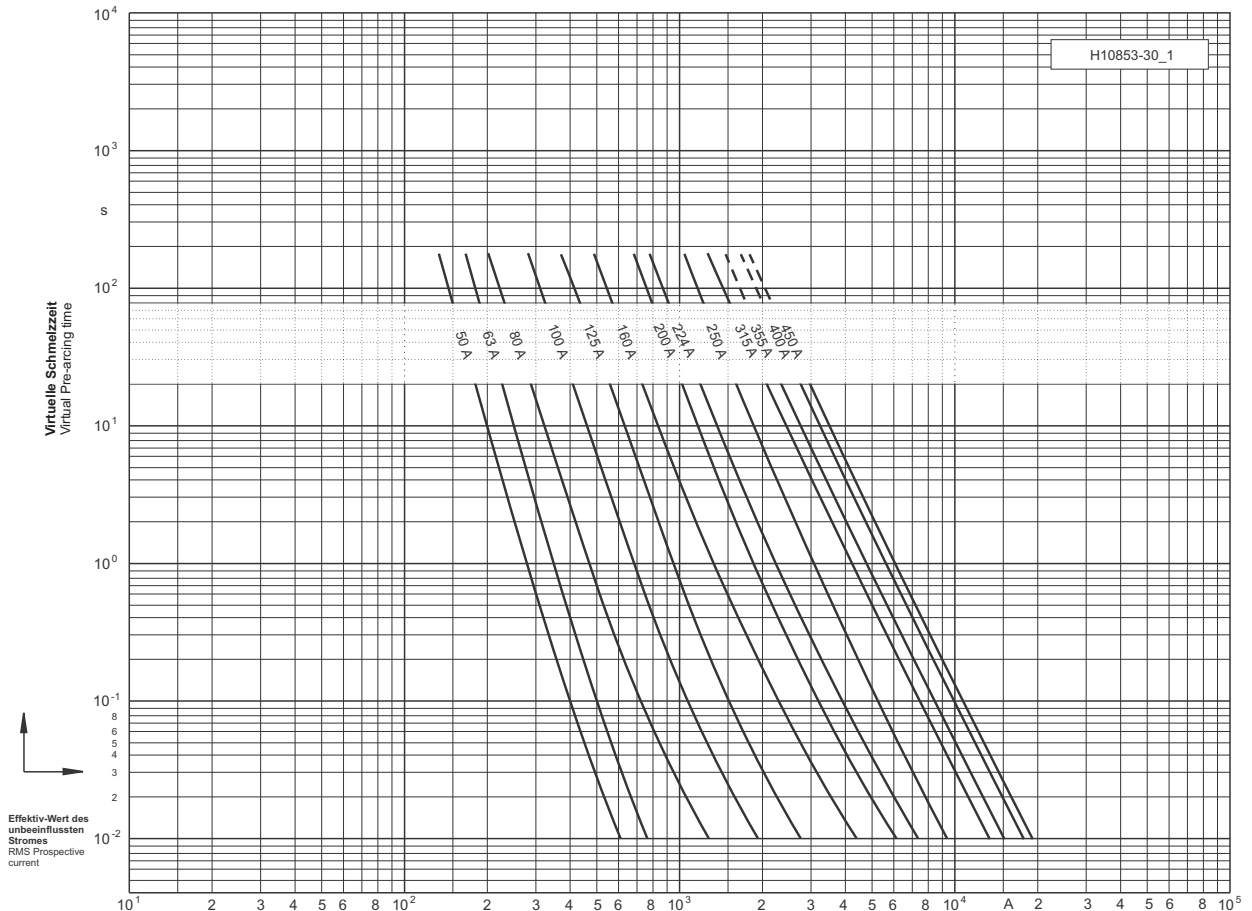

Durchlass-Strom
Cut-off current

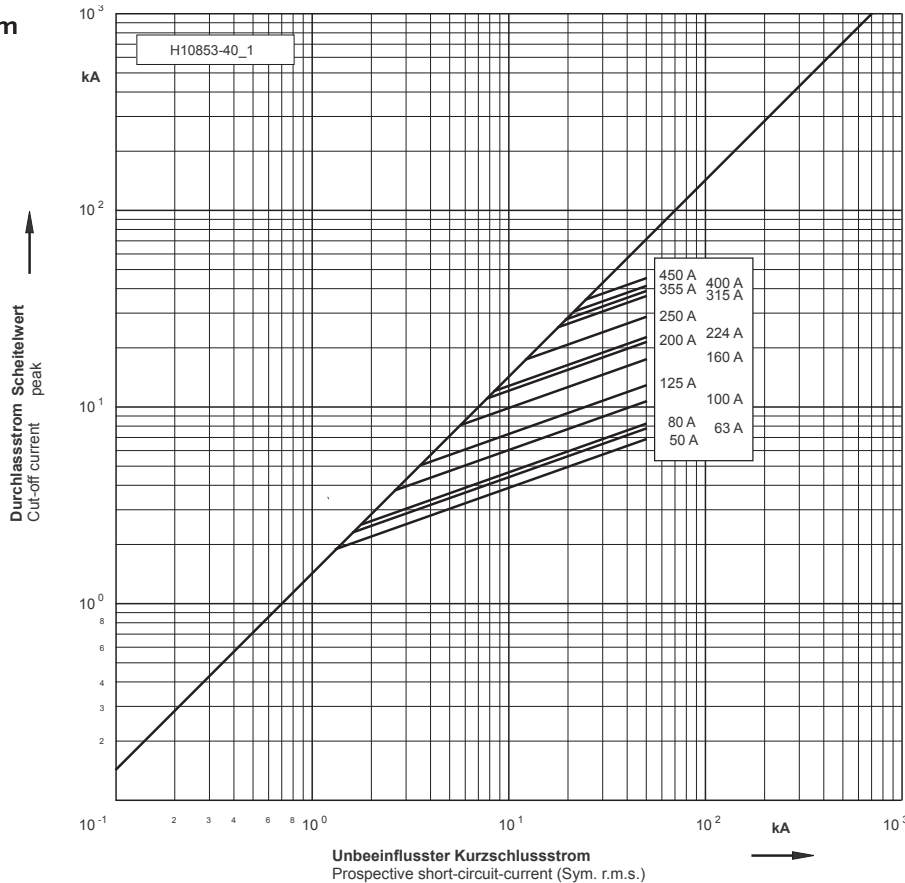

Unbeeinflusster Kurzschlussstrom
Prospective short-circuit-current (Sym. r.m.s.)

6/12 kV

"e" = 442 mm

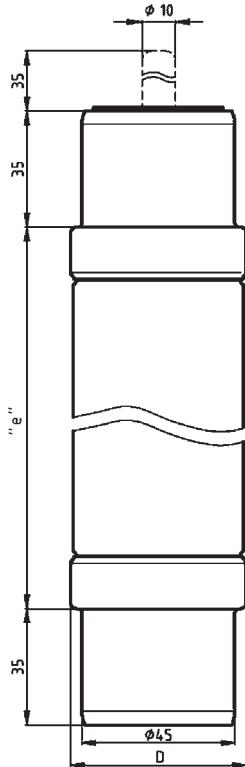
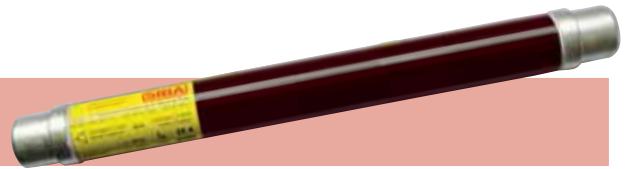

Einsatz / Application

Für Innen- und Freiluftanwendungen / Indoor and outdoor application

Verpackung / Packing 1 Stück / 1 pieces

Betriebsklasse / Class	IEC 60282-1	VDE 0670-4
Teilbereich / Back-up	DIN 43 625	IEC 60644

Bemessungs- spannung Rated Voltage	Artikel Article	Bemessungsstrom Rated Current	Länge "e" Length "e"	Durchmesser D Diameter D	Anzahl Siche- rungen Number of Barrels
kV		A	mm	mm	
6/12	30 101 53	50 - 63	442	53	1
	30 102 53	80 - 125		67	1
	30 103 53	160		85	1
	30 103 54	200		85	1

Bemessungsstrom Rated Current	Artikel Nr. Article No.	Gewicht Weight	Bemessungs- ausschaltstrom Rated Breaking Current - I ₁	Minimaler Ausschalt- strom Min. Breaking Current - I ₃	Schmelzintegral Pre-Arcing-I ² t- Value	Ausschaltin- tegral Total I ² t-Value	Leistungs- abgabe Power Loss	Kaltwider- stand Cold Resi- stance
A		kg/1	kA	A	A ² s	A ² s	W	mΩ
50	30 101 53.50	1,6	50	140	3.400	16.000	60	18
63	30 101 53.63	1,6	50	165	5.400	25.000	69	15
80	30 102 53.80	2,0	50	200	6.200	29.000	73	13
100	30 102 53.100	2,0	50	285	14.000	65.000	95	8,5
125	30 102 53.125	2,0	50	375	25.000	115.000	131	6,3
160	30 103 53.160	3,8	50	490	64.000	295.000	149	4
200	30 103 54.200	3,8	50	690	121.000	559.000	174	3

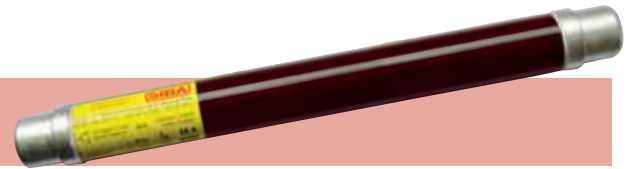

6/12 kV "e" = 442 mm

Zeit/Strom-Kennlinie
Time-current characteristic

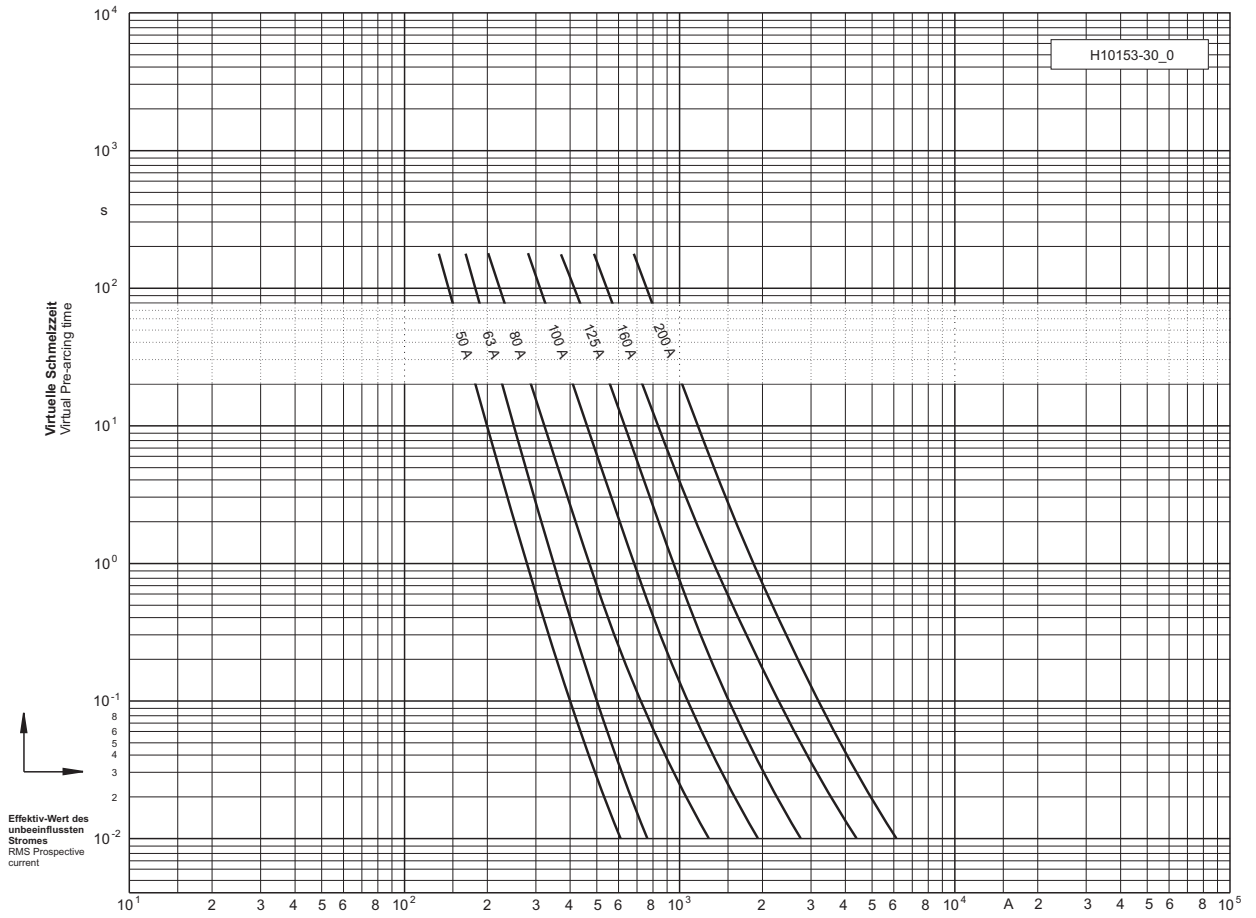

Durchlass-Strom
Cut-off current

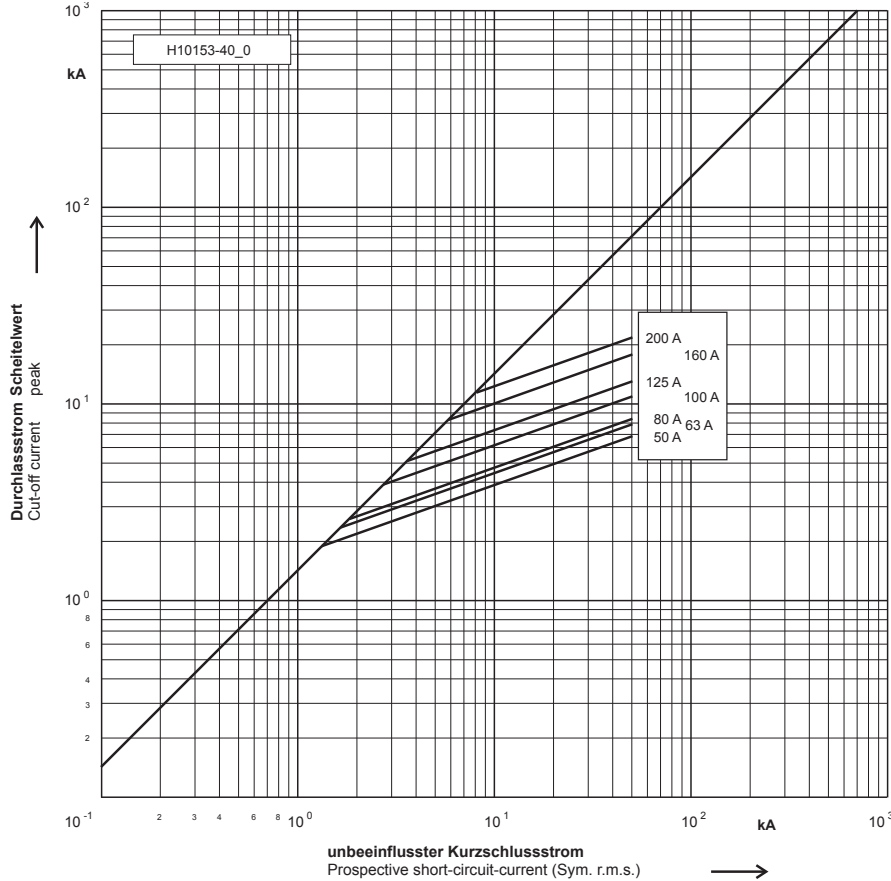

2,4-7,2kV "e" = 442 mm

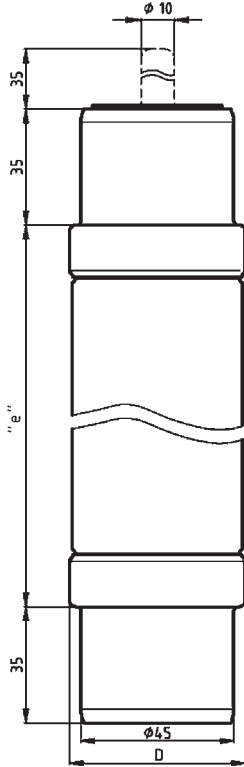
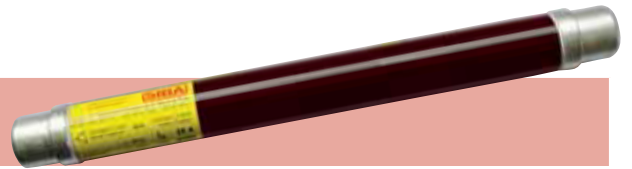

Einsatz / Application

Für Innen- und Freiluftanwendungen / Indoor and outdoor application

Verpackung / Packing 1 Stück / 1 piece

Betriebsklasse / Class Teilbereich / Back-up R-rated / R-rated		IEC 60282-1 DIN 43 625	IEC 60644 ANSI C37.46		
Bemessungs- spannung Rated Voltage	Artikel Article	Bemessungsstrom Rated Current	Länge "e" Length "e"	Durchmesser D Diameter D	Anzahl Siche- rungen Number of Barrels
kV		A	mm	mm	
2,4-7,2	30 108 55	70 - 100	442	53	1
	30 109 55	130 - 170		67	1
	30 110 55	200 - 230		85	1
2,4-7,2	30 111 55	390 - 450		85	2
2,4-7,2	30 112 55	650		85	3
2,4-4.8	30 112 55	700		85	3

Bemessungs- strom Rated Current	Artikel Nr. Article No.	Gewicht Weight	Bemessungs- ausschaltstrom Rated Breaking Current - I ₁	Minimaler Ausschaltstrom Min. Breaking Current - I ₃	Schmelz- integral Pre-Arcing- I ² t-Value	Ausschaltintegral Total I ² t-Value	Leistungs- abgabe Power Loss	Kaltwider- stand Cold Resistance
A		kg/1	kA	A	A ² s	A ² s	W	mΩ
70	30 108 55.2R	1,6	50	160	5.400	24.400	63	10
100	30 108 55.3R	1,6	50	220	9.000	41.400	106	7
130	30 109 55.4R	1,6	50	320	20.400	91.500	112	5
150	30 109 55.5R	1,6	50	400	37.600	169.400	119	3,7
170	30 109 55.6R	1,6	50	480	62.200	280.100	125	2,8
200	30 110 55.9R	1,9	50	690	100.400	462.000	123	2,1
230	30 110 55.12R	1,9	50	900	170.000	764.000	118	1,6
390	30 111 55.18R	3,8	50	1.400	402.000	1.850.000	246	1,1
450	30 111 55.24R	3,8	50	1.800	678.000	3.053.000	236	0,8
650	30 112 55.36R	3,8	50	2.600	1.527.000	6.869.000	354	0,55
700	30 112 55.48R	5,7	50	3.000	2.766.000	12.447.000	476	0,45

2,4-7,2kV "e" = 442 mm

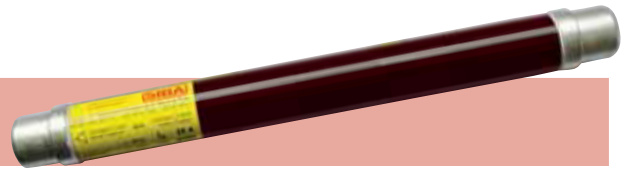

Zeit/Strom-Kennlinie
Time-current characteristic

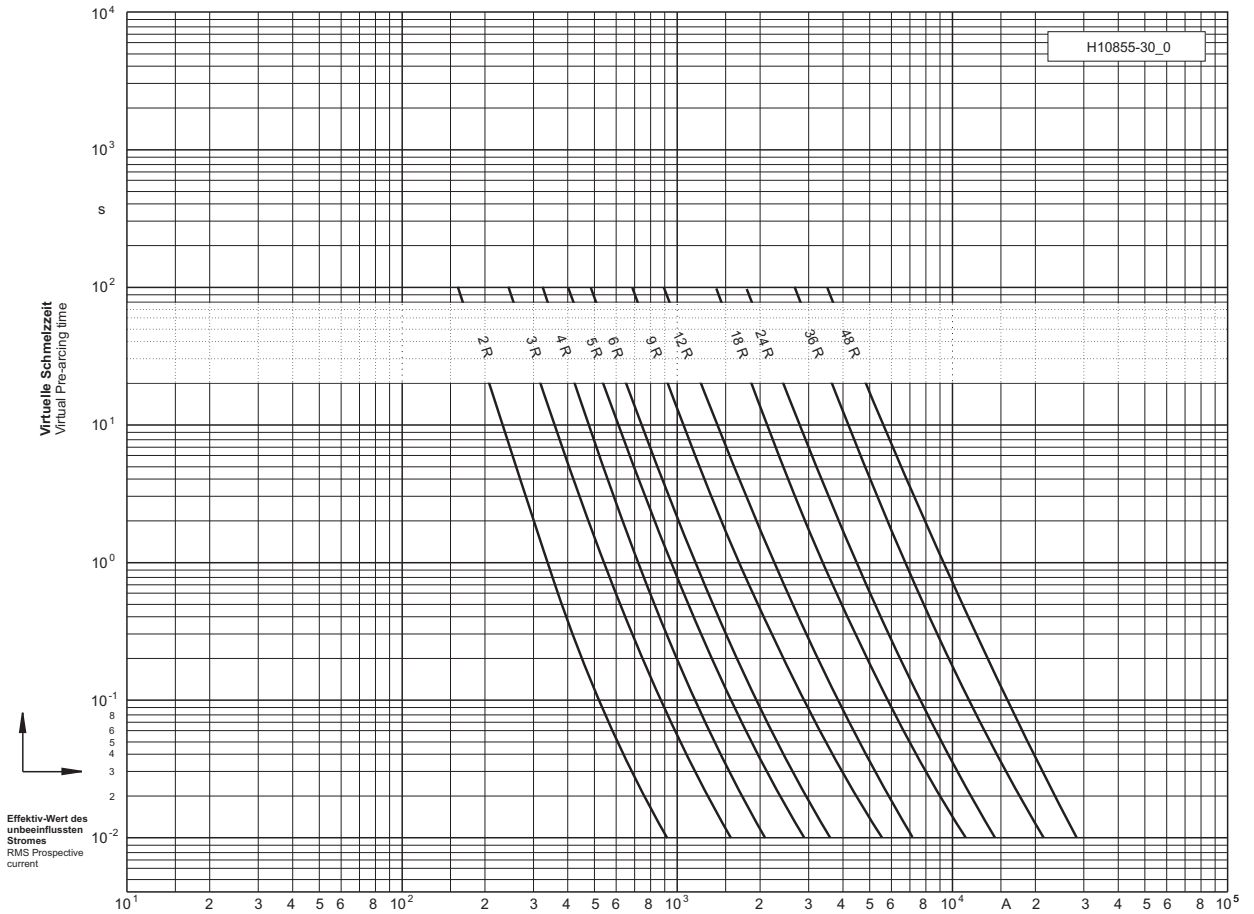

Durchlass-Strom
Cut-off current

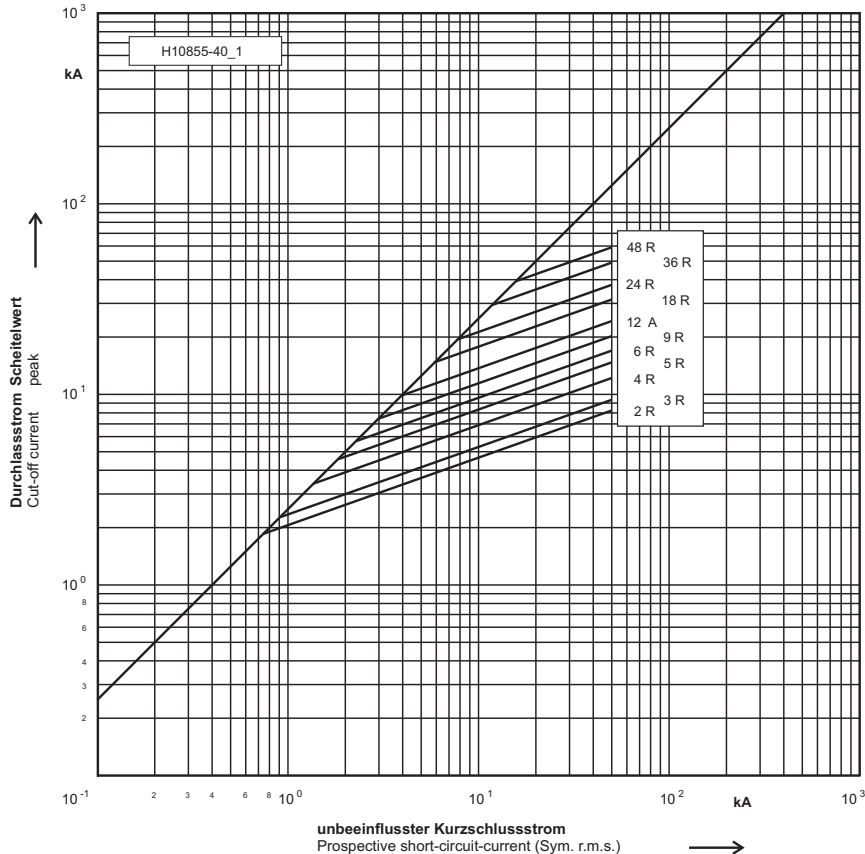

3/7,2 kV "e" = 192 mm / 292 mm

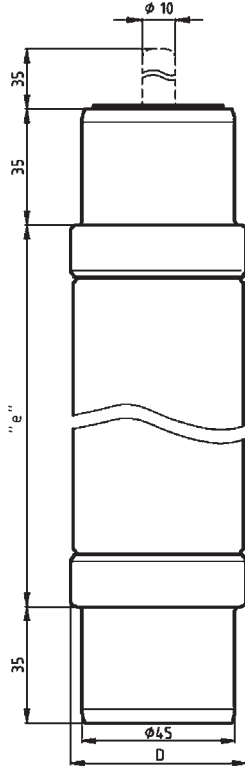
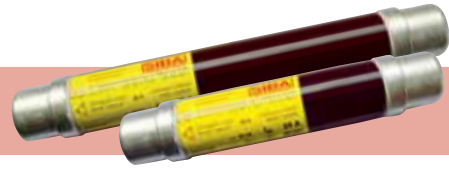

Mit und ohne Schlagstift 80N / With and without striker-pin 80N
Nach DIN 43 625 / Acc. DIN 43 625

Einsatz / Application

Für Innen- und Freiluftanwendungen / Indoor and outdoor application

Verpackung / Packing 1 Stück / 1 piece

Betriebsklasse / Class Teilbereich / Back-up	IEC 60282-1 DIN 43 625	VDE 0670-4
--	---	-------------------

Bemessungs- spannung Rated Voltage	Artikel Article	Bemessungsstrom Rated Current	Länge "e" Length "e"	Durchmesser D Diameter D
kV		A	mm	mm
3/7,2	30 002 11	0,5 - 5	192	53
	30 002 13	2 - 5	192	
	30 098 13	2 - 5	292	

Bemessungs- strom Rated Current	Artikel Nr. Article No.		Gewicht Weight	Bemessungs- ausschaltstrom Rated Breaking Current - I ₁	Minimaler Ausschaltstrom Min. Breaking Current - I ₃	Schmelz- integral Pre- Arcing- I ² t-Value	Ausschaltintegral Total I ² t-Value		Leistungs- abgabe Power Loss	Kaltwider- stand Cold Resistance
	ohne Schlagst. w/o striker pin	mit Schlagstift with striker pin					U _n min	U _n max		
A	ohne Schlagst. w/o striker pin	mit Schlagstift with striker pin	kg/1	kA	A	A ² s	A ² s	A ² s	W	mΩ
0,5	30 002 11.0,5	-	1,2	63	5	1,6	3,2	5,9	3,6	13.250
1	30 002 11.1	-	1,2	63	8	0,63	1,8	2,8	2,8	2.100
2	30 002 11.2	30 002 13.2	1,2	63	16	3,2	9,8	12	5,0	935
	-	30 098 13.2	1,6							
2,5	30 002 11.2,5	30 002 13.2,5	1,2	63	20	7,2	14,5	22	5,2	630
	-	30 098 13.2,5	1,6							
3,15	30 002 11.3,15	30 002 13.3,15	1,2	63	24	17	32	48	5,5	420
	-	30 098 13.3,15	1,6							
4	30 002 11.4	30 002 13.4	1,2	63	32	31	62	90	7,2	310
	-	30 098 13.4	1,6							
5	30 002 11.5	30 002 13.5	1,2	63	40	40	80	125	5,0	141
	-	30 098 13.5	1,6							

3/7,2 kV

"e" = 192 mm / 292 mm

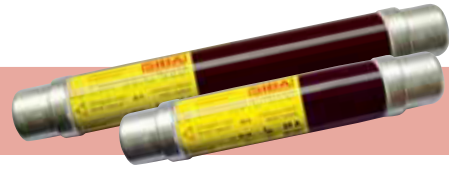

Zeit/Strom-Kennlinie
Time-current characteristic

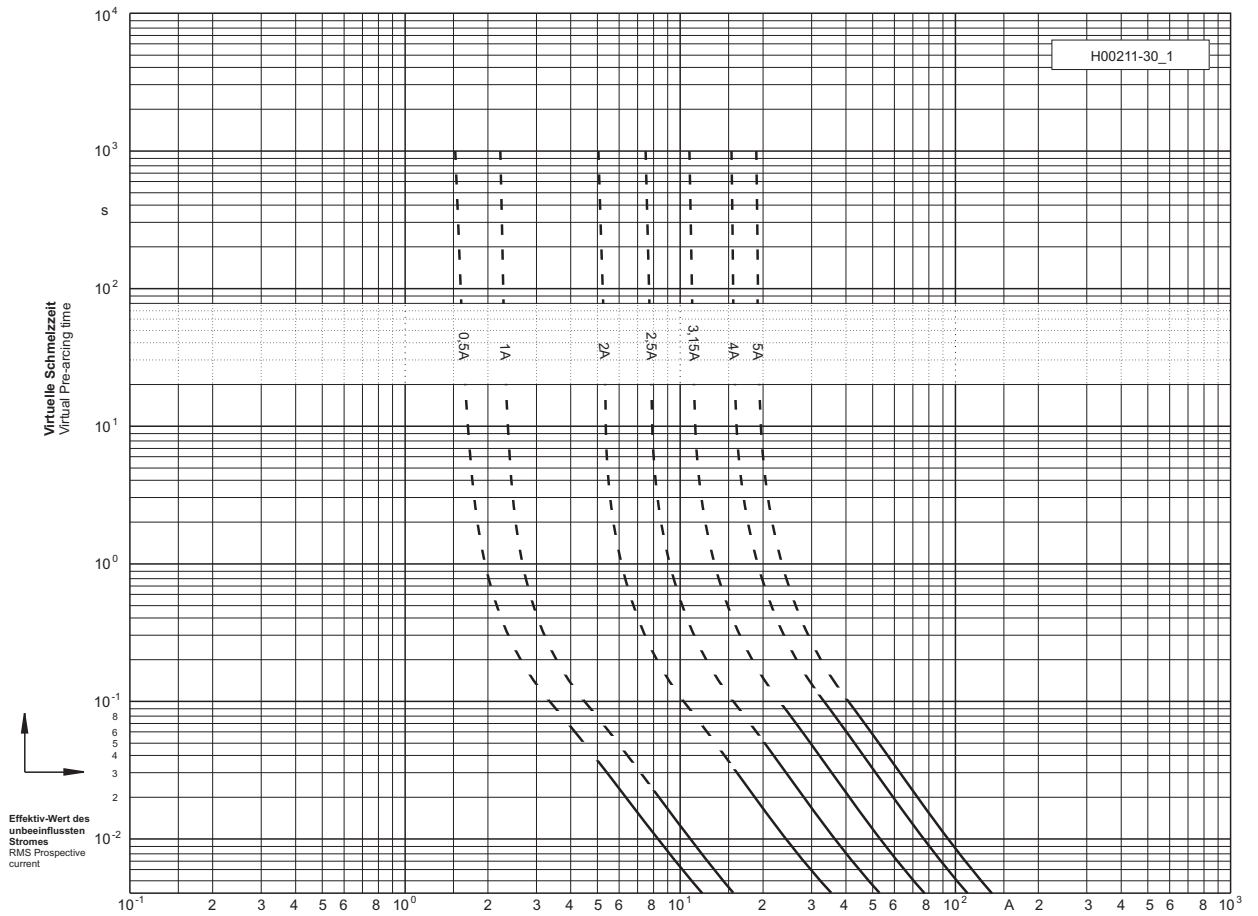

Durchlass-Strom
Cut-off current

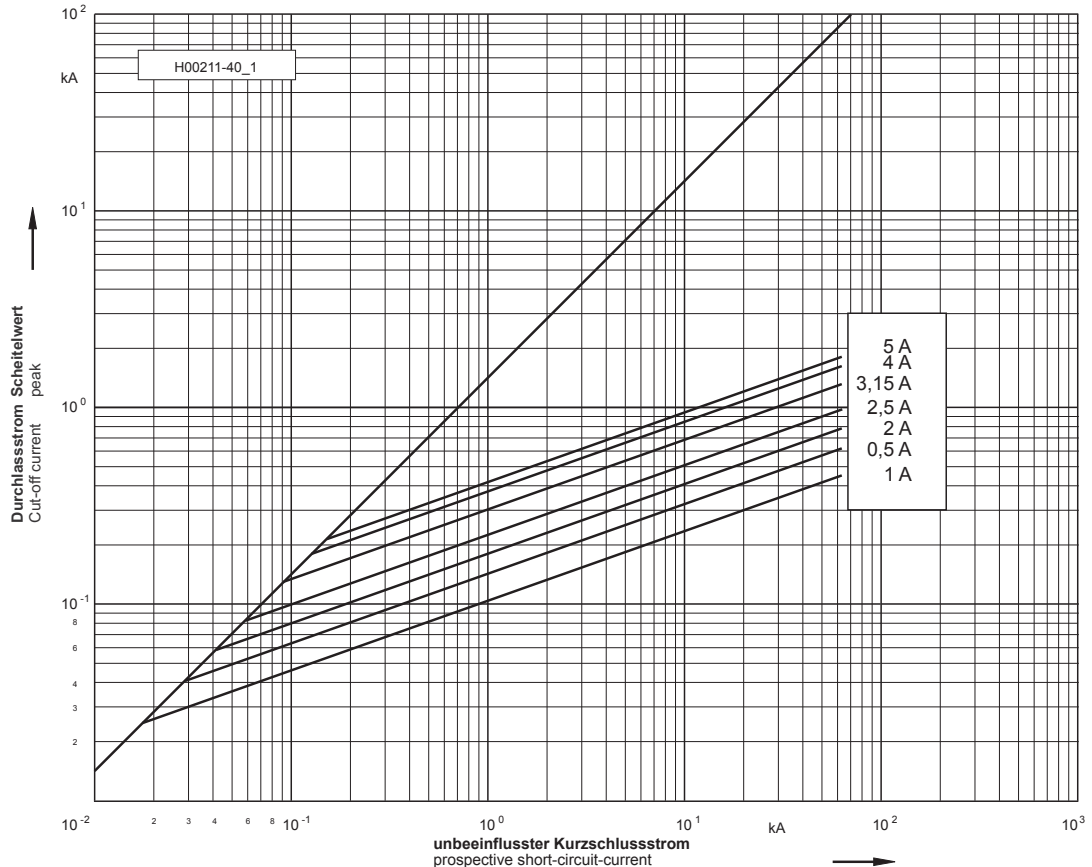

6/12 kV

"e" = 192 mm / 292 mm

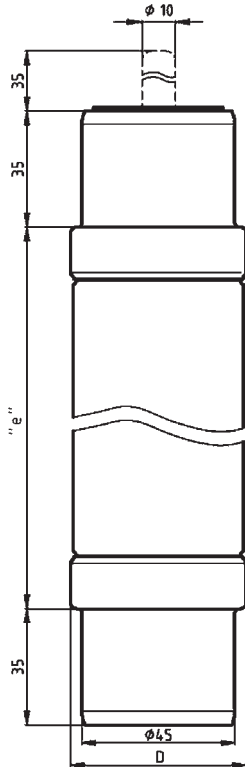

Mit und ohne Schlagstift 80N / With and without striker-pin 80N
Nach DIN 43 625 / Acc. DIN 43 625

Einsatz / Application

Für Innen- und Freiluftanwendungen / Indoor and outdoor application

Verpackung / Packing 1 Stück / 1 piece

Betriebsklasse / Class	IEC 60282-1	VDE 0670-4
Teilbereich / Back-up	DIN 43 625	

Bemessungs- spannung Rated Voltage	Artikel Article	Bemessungsstrom Rated Current	Länge "e" Length "e"	Durchmesser D Diameter D
kV		A	mm	mm
6/12	30 119 11	0,5 - 5	192	53
	30 004 11	0,5 - 5	292	
	30 119 13	2 - 5	192	
	30 004 13	2 - 5	292	

Bemessungs- strom Rated Current	Artikel Nr. Article No.		Gewicht Weight	Bemessungs- ausschaltstrom Rated Breaking Current - I ₁	Minimaler Ausschaltstrom Min. Breaking Current - I ₃	Schmelz- integral Pre- Arcing- I ² t-Value	Ausschaltintegral Total I ² t-Value		Leistungs- abgabe Power Loss	Kaltwider- stand Cold Resistance
	ohne Schlagst. w/o striker pin	mit Schlagstift with striker pin					U _n min	U _n max		
0,5	30 119 11.0,5	-	1,2	63	5	1,6	3,2	5,9	6,1	22.130
	30 004 11.0,5	-	1,6							
1	30 119 11.1	-	1,2	63	8	0,63	1,2	1,8	4,8	3.510
	30 004 11.1	-	1,6							
2	30 119 11.2	30 119 13.2	1,2	63	16	3,2	6,5	9,8	8,2	1.570
	30 004 11.2	30 004 13.2	1,6							
2,5	30 119 11.2,5	30 119 13.2,5	1,2	63	20	7,2	15	23	8,9	950
	30 004 11.2,5	30 004 13.2,5	1,6							
3,15	30 119 11.3,15	30 119 13.3,15	1,2	63	24	17	32	48	9,6	700
	30 004 11.3,15	30 004 13.3,15	1,6							
4	30 119 11.4	30 119 13.4	1,2	63	32	31	62	90	12	520
	30 004 11.4	30 004 13.4	1,6							
5	30 119 11.5	30 119 13.5	1,2	63	40	40	80	125	8,3	236
	30 004 11.5	30 004 13.5	1,6							



6/12 kV "e" = 192 mm / 292 mm

Zeit/Strom-Kennlinie
Time-current characteristic

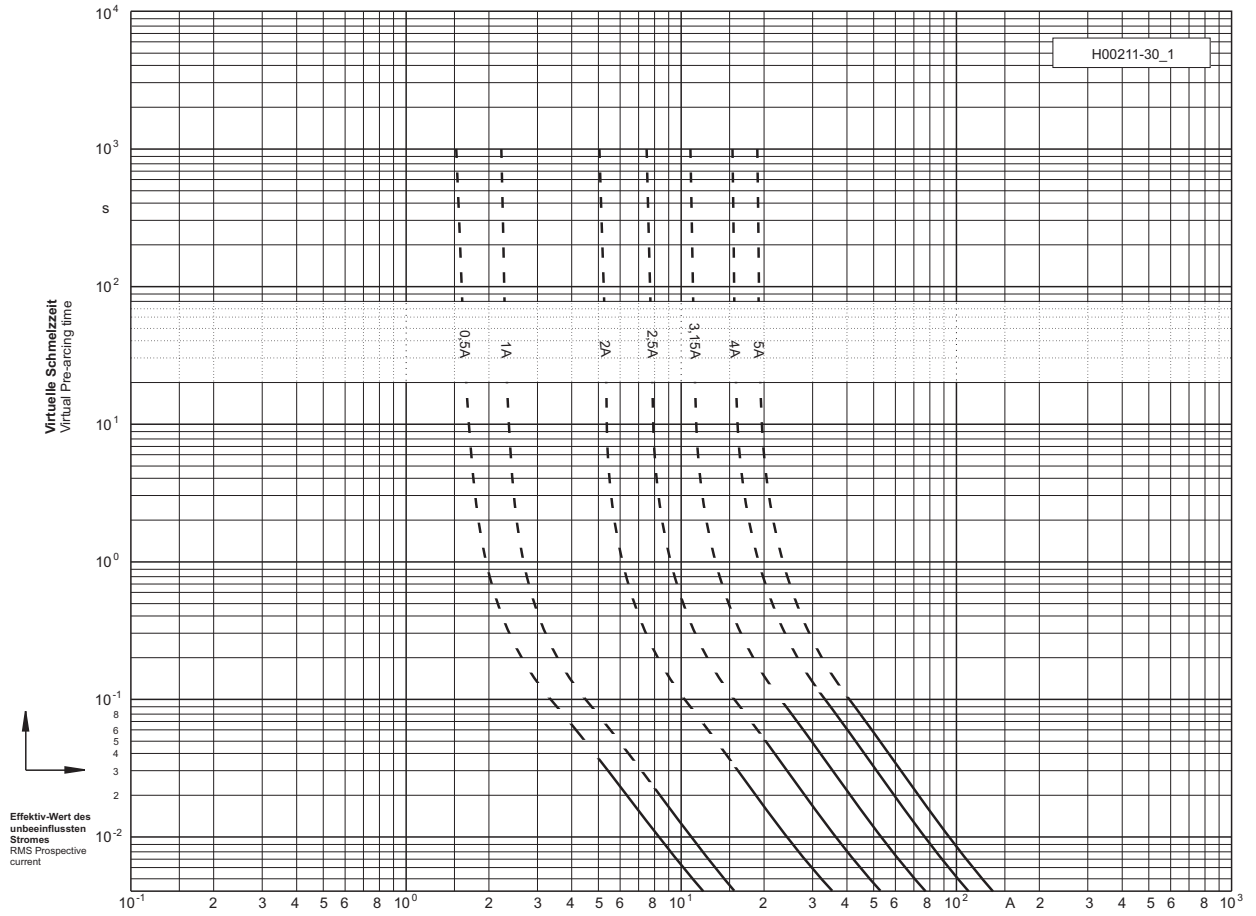

Durchlass-Strom
Cut-off current

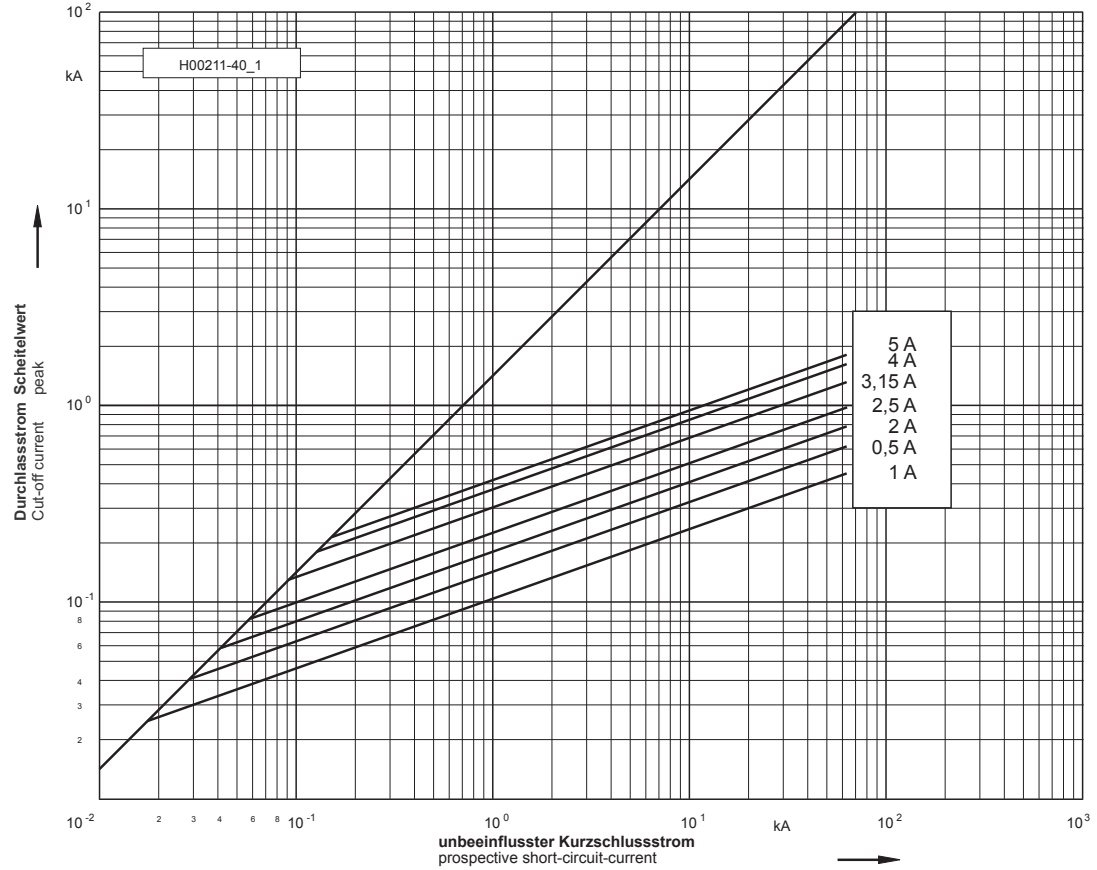

10/17,5 kV "e" = 192 mm / 367 mm

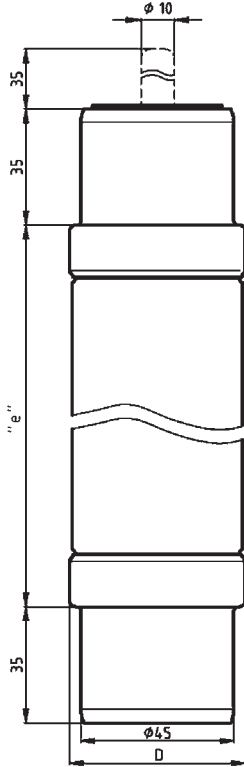

Mit und ohne Schlagstift 80N / With and without striker-pin 80N
Nach DIN 43 625 / Acc. DIN 43 625

Einsatz / Application

Für Innen- und Freiluftanwendungen / Indoor and outdoor application

Verpackung / Packing 1 Stück / 1 piece

Betriebsklasse / Class	IEC 60282-1	VDE 0670-4
Teilbereich / Back-up	DIN 43 625	

Bemessungs- spannung Rated Voltage	Artikel Article	Bemessungsstrom Rated Current	Länge "e" Length "e"	Durchmesser D Diameter D
kV		A	mm	mm
10/17,5	30 179 11	0,5 - 5	192	53
	30 176 11	0,5 - 5	367	
	30 179 13	2 - 5	192	
	30 176 13	2 - 5	367	

Bemessungs- strom Rated Current	Artikel Nr. Article No.		Gewicht Weight	Bemessungs- ausschaltstrom Rated Breaking Current - I ₁	Minimaler Ausschaltstrom Min. Breaking Current - I ₃	Schmelz- integral Pre- Arcing- I ² t-Value	Ausschaltintegral Total I ² t-Value		Leistungs- abgabe Power Loss	Kaltwider- stand Cold Resistance
	ohne Schlagst. w/o striker pin	mit Schlagstift with striker pin					U _n min	U _n max		
0,5	30 179 11.0,5	-	1,2	63	5	1,6	3,2	5,9	8,1	29.480
	30 176 11.0,5	-	2,0							
1	30 179 11.1	-	1,2	63	8	0,63	1,2	1,8	6,2	4.640
	30 176 11.1	-	2,0							
2	30 179 11.2	30 179 13.2	1,2	63	16	3,2	6,5	9,8	11	2.060
	30 176 11.2	30 176 13.2	2,0							
2,5	30 179 11.2,5	30 179 13.2,5	1,2	63	20	7,2	17	24	12	1.400
	30 176 11.2,5	30 176 13.2,5	2,0							
3,15	30 179 11.3,15	30 179 13.3,15	1,2	63	24	17	32	48	13	920
	30 176 11.3,15	30 176 13.3,15	2,0							
4	30 179 11.4	30 179 13.4	1,2	63	32	31	62	90	16	690
	30 176 11.4	30 176 13.4	2,0							
5	30 179 11.5	30 179 13.5	1,2	63	40	40	80	125	11	314
	30 176 11.5	30 176 13.5	2,0							

10/17,5 kV "e" = 192 mm / 367 mm



Zeit/Strom-Kennlinie
Time-current characteristic

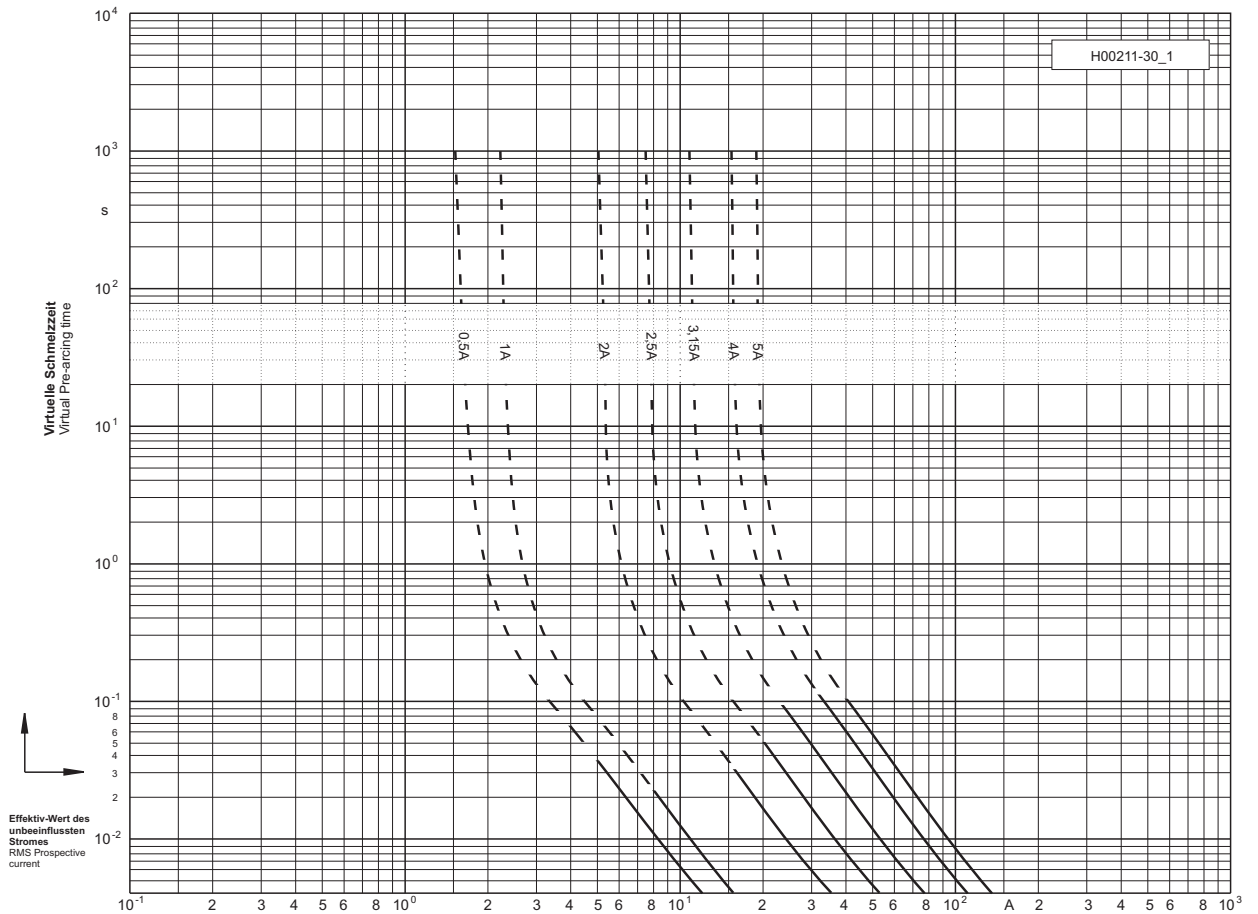

Durchlass-Strom
Cut-off current

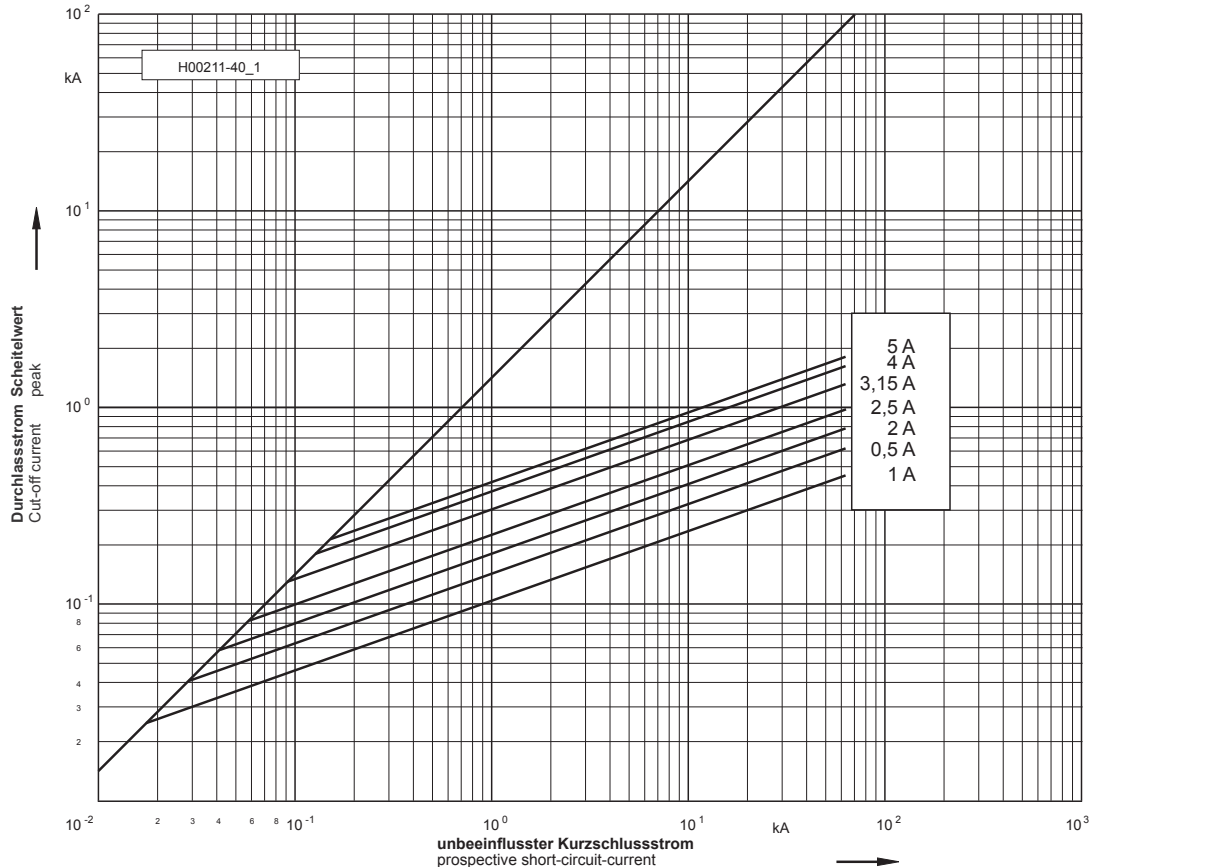

10/17,5 kV "e" = 292 mm

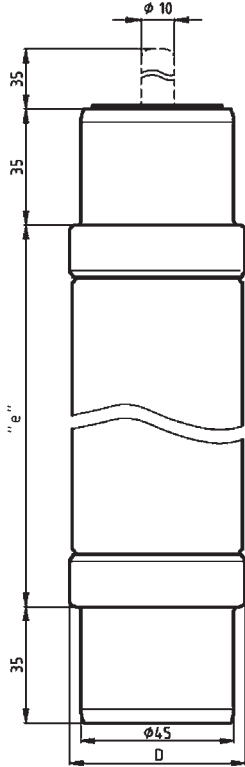

Mit und ohne Schlagstift 80N / With and without striker-pin 80N
Nach DIN 43 625 / Acc. DIN 43 625

Einsatz / Application

Für Innen- und Freiluftanwendungen / Indoor and outdoor application

Verpackung / Packing 1 Stück / 1 piece

Betriebsklasse / Class	IEC 60282-1	VDE 0670-4
Teilbereich / Back-up	DIN 43 625	

Bemessungs- spannung Rated Voltage	Artikel Article	Bemessungsstrom Rated Current	Länge "e" Length "e"	Durchmesser D Diameter D
kV		A	mm	mm
10/17,5	30 255 11	0,5 - 5	292	53
	30 221 11	0,5 - 5		67
	30 255 13	2 - 5		53
	30 221 13	2 - 5		67

Bemessungs- strom Rated Current	Artikel Nr. Article No.		Gewicht Weight	Bemessungs- ausschaltstrom Rated Breaking Current - I ₁	Minimaler Ausschaltstrom Min. Breaking Current - I ₃	Schmelz- integral Pre- Arcing- I ² t-Value	Ausschaltintegral Total I ² t-Value		Leistungs- abgabe Power Loss	Kaltwider- stand Cold Resistance
	ohne Schlagst. w/o striker pin	mit Schlagstift with striker pin					U _n min	U _n max		
0,5	30 255 11.0,5	-	1,6	63	5	1,6	3,2	5,9	8,1	29.480
	30 221 11.0,5	-	2,0							
1	30 255 11.1	-	1,6	63	8	0,63	1,2	1,8	6,2	4.640
	30 221 11.1	-	2,0							
2	30 255 11.2	30 255 13.2	1,6	63	16	3,2	6,5	9,8	11	2.060
	30 221 11.2	30 221 13.2	2,0							
2,5	30 255 11.2,5	30 255 13.2,5	1,6	63	20	7,2	17	24	12	1.400
	30 221 11.2,5	30 221 13.2,5	2,0							
3,15	30 255 11.3,15	30 255 13.3,15	1,6	63	24	17	32	48	13	920
	30 221 11.3,15	30 221 13.3,15	2,0							
4	30 255 11.4	30 255 13.4	1,6	63	32	31	62	90	16	690
	30 221 11.4	30 221 13.4	2,0							
5	30 255 11.5	30 255 13.5	1,6	63	40	40	80	125	11	314
	30 221 11.5	30 221 13.5	2,0							

10/17,5 kV "e" = 292 mm



Zeit/Strom-Kennlinie
Time-current characteristic

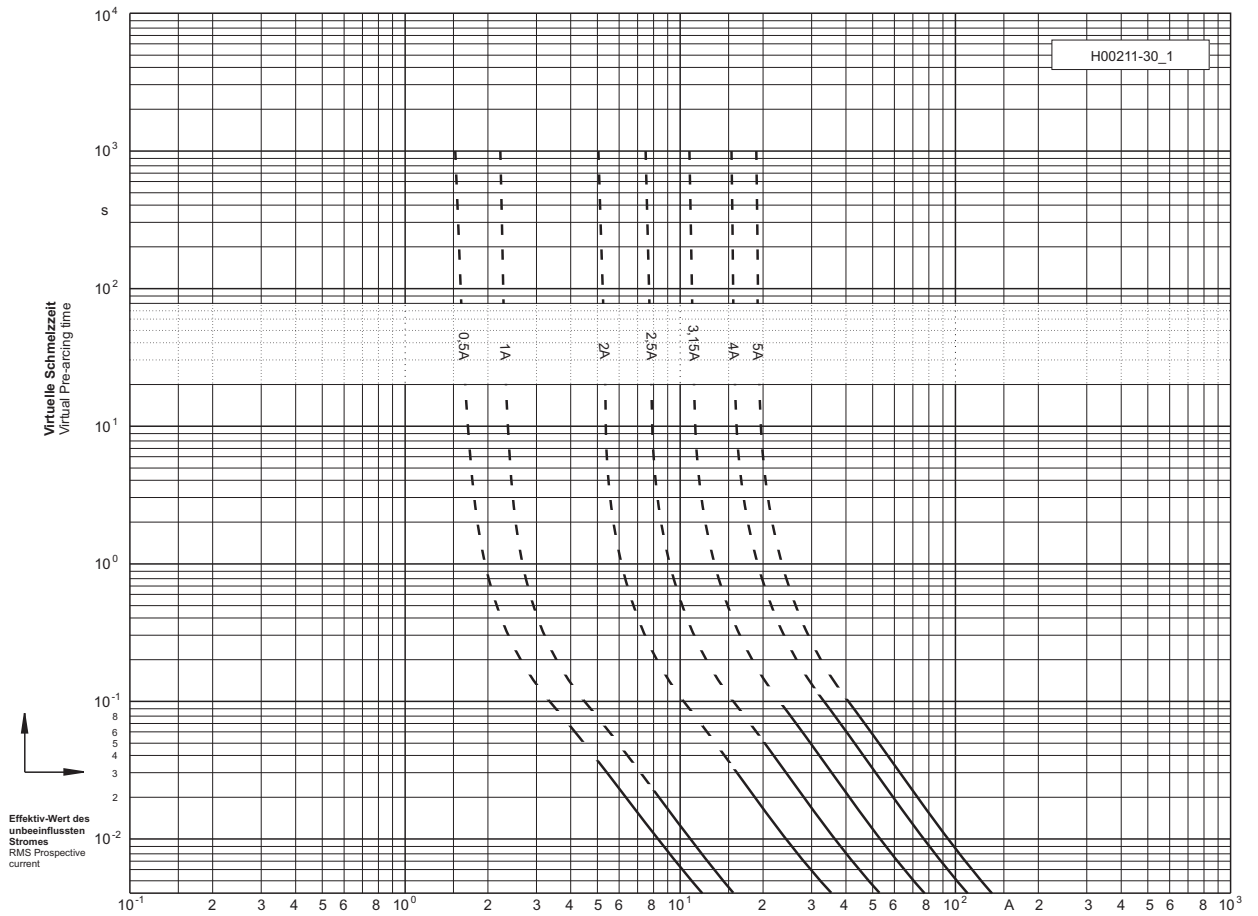

Durchlass-Strom
Cut-off current

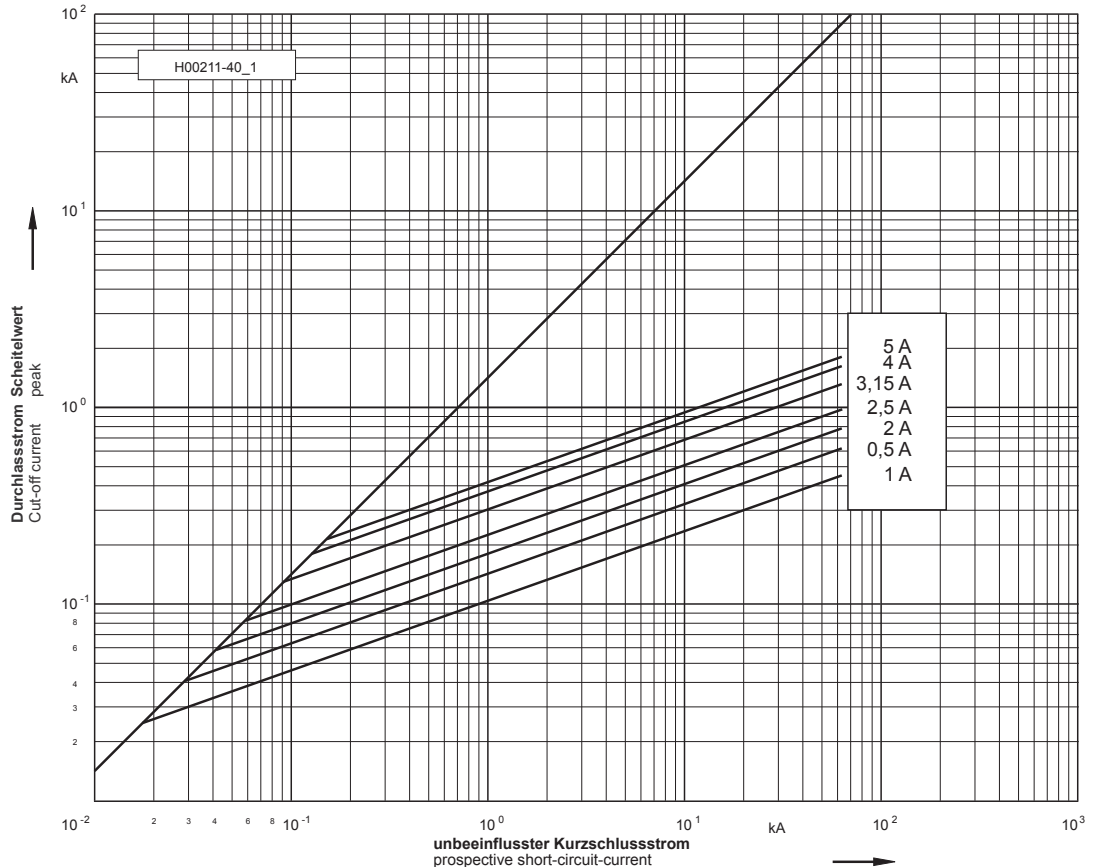

10/24 kV "e" = 292 mm / 442 mm

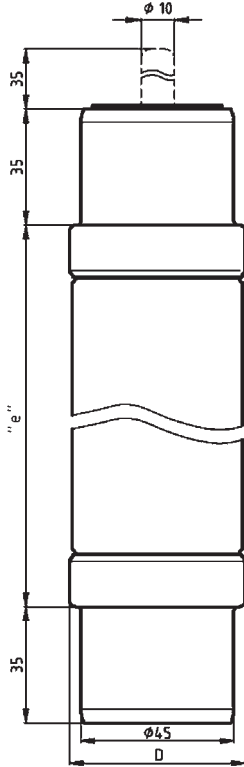
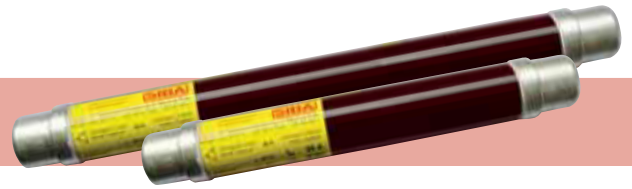

Mit und ohne Schlagstift 80N / With and without striker-pin 80N
Nach DIN 43 625 / Acc. DIN 43 625

Einsatz / Application

Für Innen- und Freiluftanwendungen / Indoor and outdoor application

Verpackung / Packing 1 Stück / 1 piece

Betriebsklasse / Class	IEC 60282-1	VDE 0670-4
Teilbereich / Back-up	DIN 43 625	

Bemessungs- spannung Rated Voltage	Artikel Article	Bemessungsstrom Rated Current	Länge "e" Length "e"	Durchmesser D Diameter D
kV		A	mm	mm
10/24	30 180 11	0,5 - 5	292	53
	30 006 11	0,5 - 5	442	
	30 180 13	2 - 5	292	
	30 006 13	2 - 5	442	

Bemessungs- strom Rated Current	Artikel Nr. Article No.		Gewicht Weight	Bemessungs- ausschaltstrom Rated Breaking Current - I ₁	Minimaler Ausschaltstrom Min. Breaking Current - I ₃	Schmelz- integral Pre- Arcing- I ² t-Value	Ausschaltintegral Total I ² t-Value		Leistungs- abgabe Power Loss	Kaltwider- stand Cold Resistance
	ohne Schlagst. w/o striker pin	mit Schlagstift with striker pin					U _n min	U _n max		
0,5	30 180 11.0,5	-	2,0	63	5	1,6	3,2	5,9	11,2	40.550
	30 006 11.0,5	-	2,2							
1	30 180 11.1	-	2,0	63	8	0,63	1,2	1,8	8,6	6.450
	30 006 11.1	-	2,2							
2	30 180 11.2	30 180 13.2	2,0	63	16	3,2	6,5	9,8	15	2.850
	30 006 11.2	30 006 13.2	2,2							
2,5	30 180 11.2,5	30 180 13.2,5	2,0	63	20	7,2	19	26	16	1.920
	30 006 11.2,5	30 006 13.2,5	2,2							
3,15	30 180 11.3,15	30 180 13.3,15	2,0	63	24	17	32	48	18	1.300
	30 006 11.3,15	30 006 13.3,15	2,2							
4	30 180 11.4	30 180 13.4	2,0	63	32	31	62	90	22	950
	30 006 11.4	30 006 13.4	2,2							
5	30 180 11.5	30 180 13.5	2,0	63	40	40	80	125	15	433
	30 006 11.5	30 006 13.5	2,2							

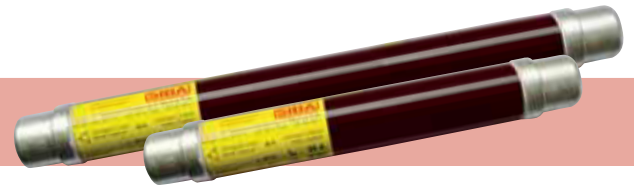

10/24 kV "e" = 292 mm / 442 mm

Zeit/Strom-Kennlinie
Time-current characteristic

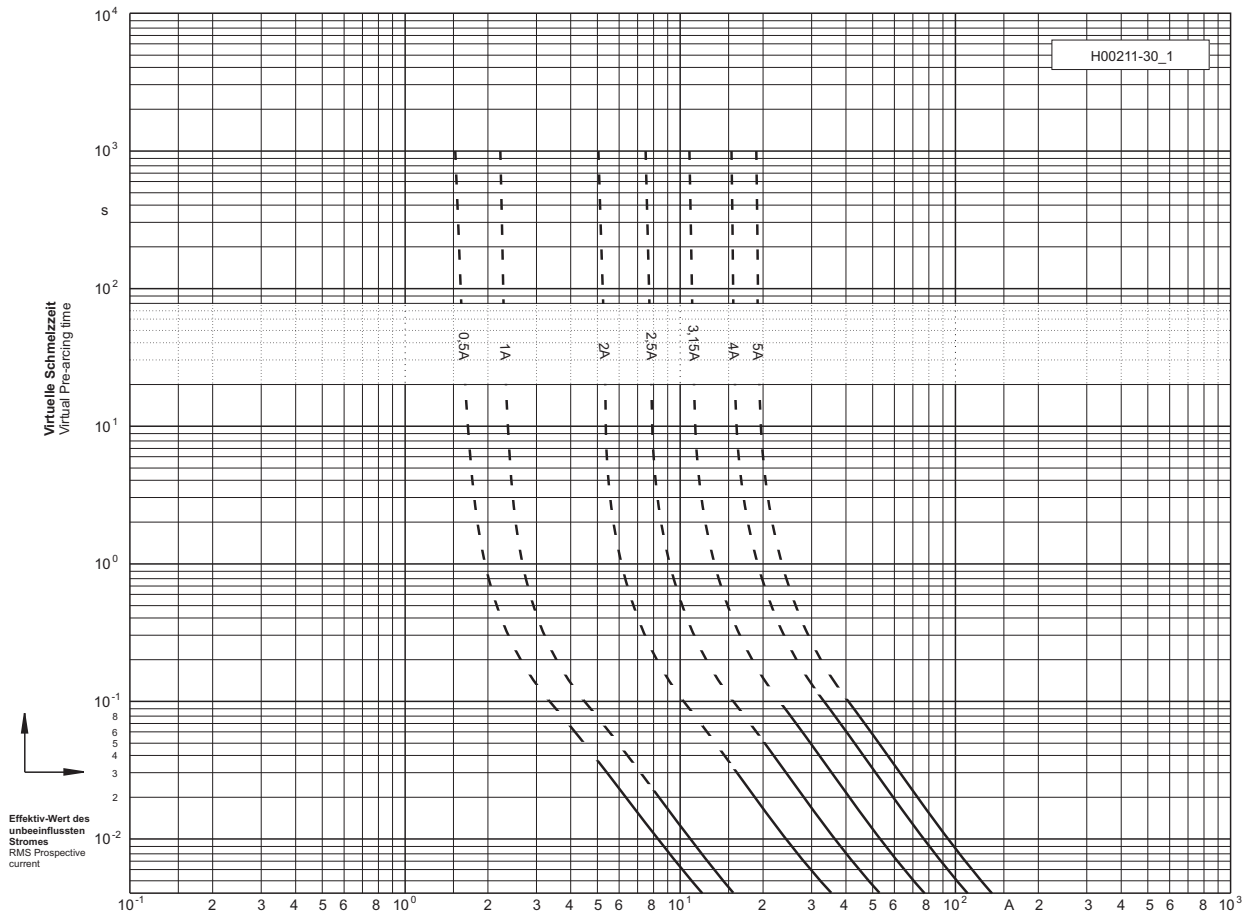

Durchlass-Strom
Cut-off current

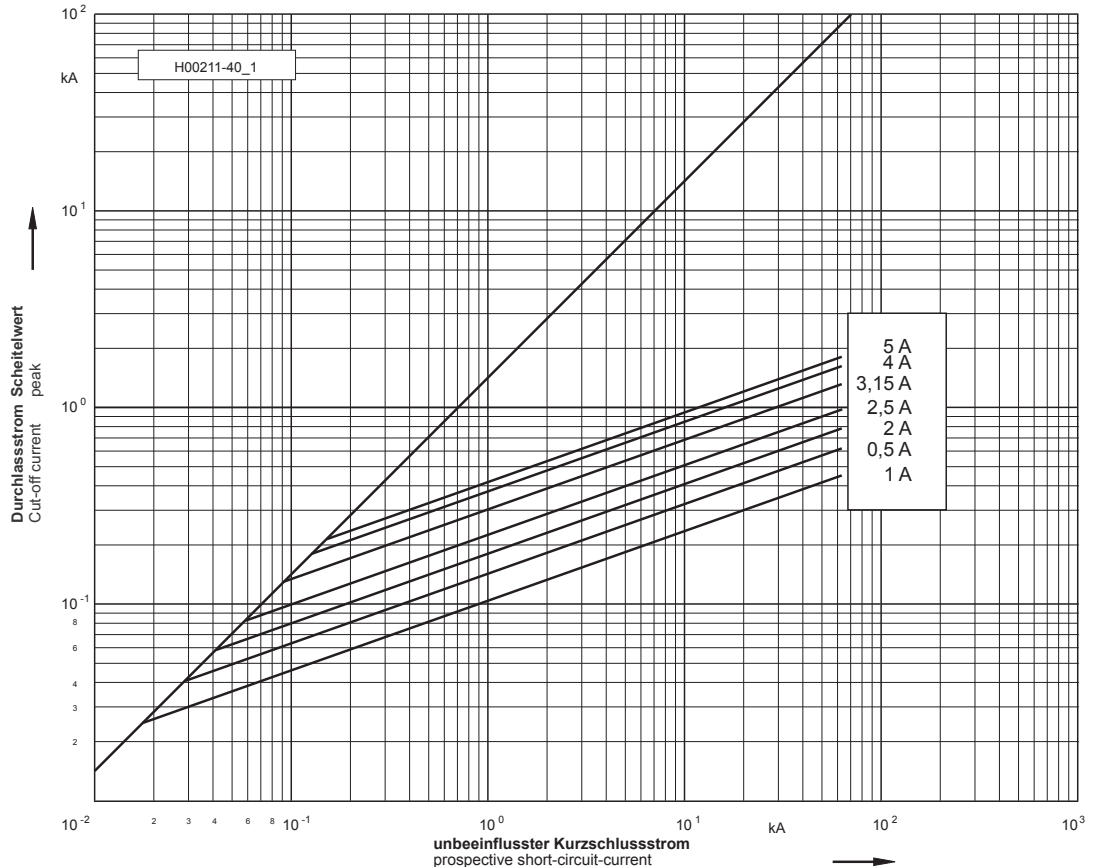

20/36 kV "e" = 292 mm

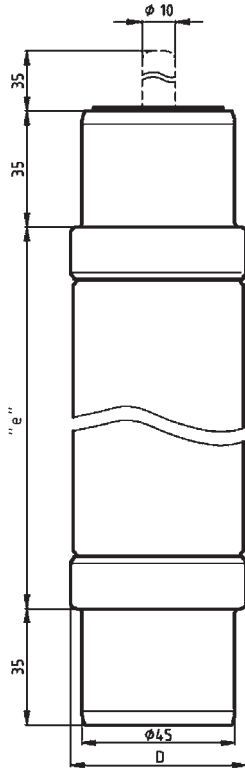

Mit und ohne Schlagstift 80N / With and without striker-pin 80N
Nach DIN 43 625 / Acc. DIN 43 625

Einsatz / Application

Für Innen- und Freiluftanwendungen / Indoor and outdoor application

Verpackung / Packing 1 Stück / 1 piece

Betriebsklasse / Class Teilbereich / Back-up	IEC 60282-1 DIN 43 625	VDE 0670-4
--	---	-------------------

Bemessungs- spannung Rated Voltage	Artikel Article	Bemessungsstrom Rated Current	Länge "e" Length "e"	Durchmesser D Diameter D
kV		A	mm	mm
20/36	30 382 11	0,5 - 5	292	53
	30 382 13	2 - 5	292	

Bemessungs- strom Rated Current	Artikel Nr. Article No.		Gewicht Weight	Bemessungs- ausschaltstrom Rated Breaking Current - I ₁	Minimaler Ausschaltstrom Min. Breaking Current - I ₃	Schmelz- integral Pre- Arcing- I ² t-Value	Ausschaltintegral Total I ² t-Value		Leistungs- abgabe Power Loss	Kaltwider- stand Cold Resistance
	ohne Schlagst. w/o striker pin	mit Schlagstift with striker pin					U _n min	U _n max		
A			kg/1	kA	A	A ² s	A ² s	A ² s	W	mΩ
0,5	30 382 11.0,5	-	2,6	40	5	1,6	3,2	5,9	17	60.800
1	30 382 11.1	-	2,6	40	8	0,63	1,2	1,8	13	9.570
2	30 382 11.2	30 382 13.2	2,6	40	16	3,2	6,5	9,8	23	4.260
2,5	30 382 11.2,5	30 382 13.2,5	2,6	40	20	7,2	21	35	22	2.600
3,15	30 382 11.3,15	30 382 13.3,15	2,6	40	24	17	32	48	26	1.900
4	30 382 11.4	30 382 13.4	2,6	40	32	31	62	90	33	1.420
5	30 382 11.5	30 382 13.5	2,6	40	40	40	80	125	23	650

20/36 kV "e" = 292 mm



**Zeit/Strom-
Kennlinie**
Time-current
characteristic

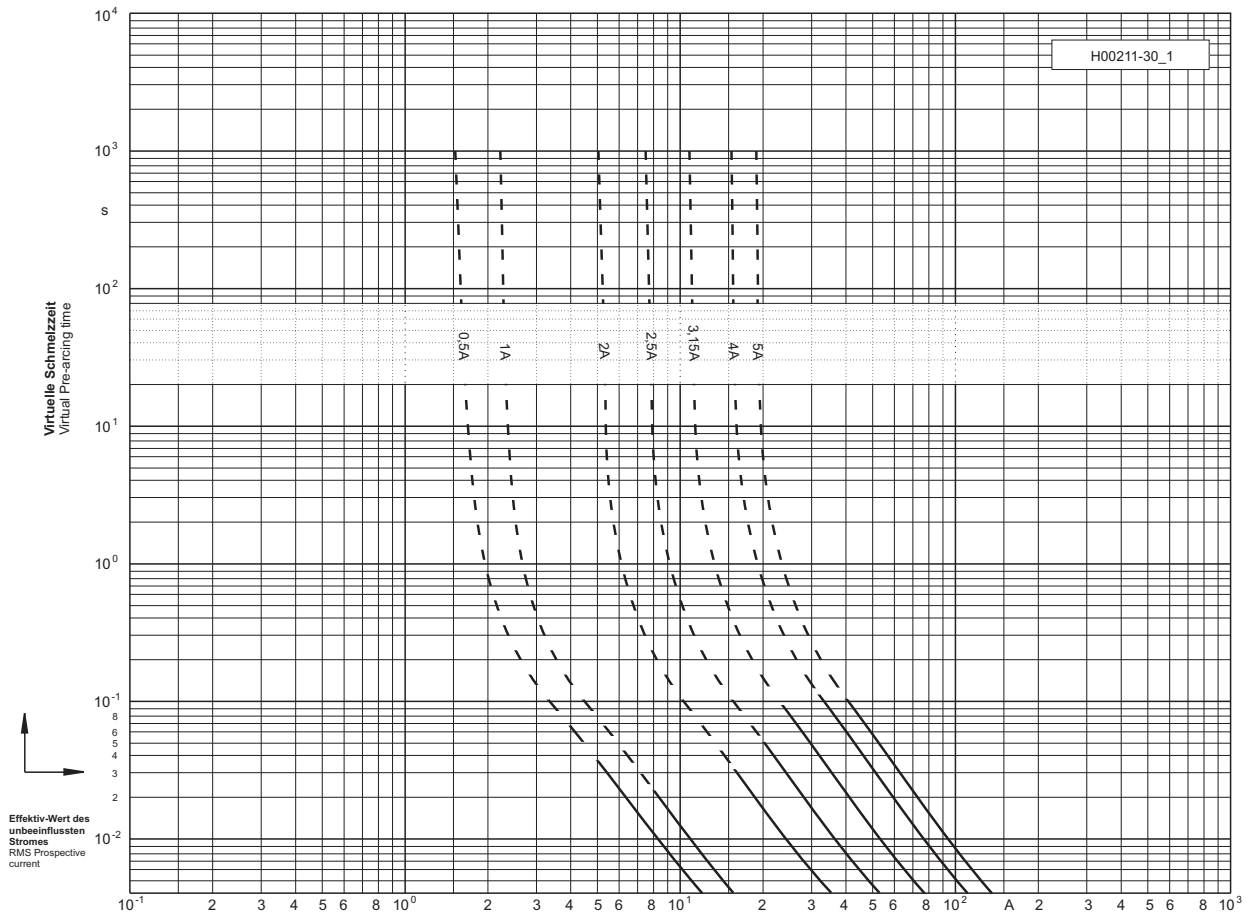

Durchlass-Strom
Cut-off current

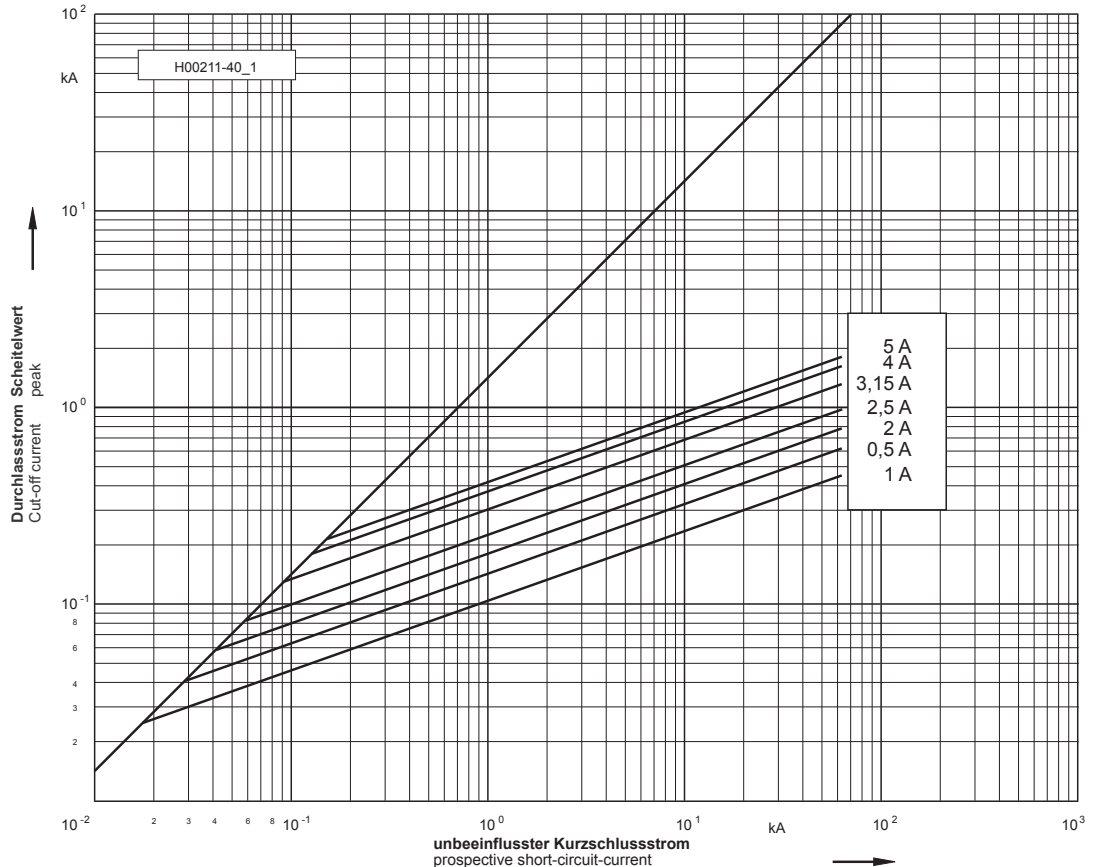

20/36 kV "e" = 442mm / 537 mm

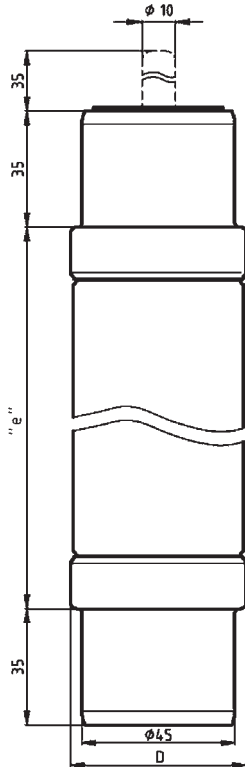

Mit und ohne Schlagstift 80N / With and without striker-pin 80N
Nach DIN 43 625 / Acc. DIN 43 625

Einsatz / Application

Für Innen- und Freiluftanwendungen / Indoor and outdoor application

Verpackung / Packing 1 Stück / 1 piece

Betriebsklasse / Class	IEC 60282-1	VDE 0670-4
Teilbereich / Back-up	DIN 43 625	

Bemessungs- spannung Rated Voltage	Artikel Article	Bemessungsstrom Rated Current	Länge "e" Length "e"	Durchmesser D Diameter D
kV		A	mm	mm
20/36	30 181 11	0,5 - 5	442	53
	30 008 11	0,5 - 5	537	
	30 181 13	2 - 5	442	
	30 008 13	2 - 5	537	

Bemessungs- strom Rated Current	Artikel Nr. Article No.		Gewicht Weight	Bemessungs- ausschaltstrom Rated Breaking Current - I ₁	Minimaler Ausschaltstrom Min. Breaking Current - I ₃	Schmelz- integral Pre- Arcing- I ² t-Value	Ausschaltintegral Total I ² t-Value		Leistungs- abgabe Power Loss	Kaltwider- stand Cold Resistance
	ohne Schlagst. w/o striker pin	mit Schlagstift with striker pin					U _n min	U _n max		
A			kg/1	kA	A	A ² s	A ² s	A ² s	W	mΩ
	0,5	30 181 11.0,5	-	2,2	40	5	1,6	3,2	5,9	17
1		30 008 11.0,5	-	2,6						
	1	30 181 11.1	-	2,2	40	8	0,63	1,2	1,8	13
2		30 008 11.1	-	2,6						
	2	30 181 11.2	30 181 13.2	2,2	40	16	3,2	6,5	9,8	23
2,5		30 008 11.2	30 008 13.2	2,6						
	2,5	30 181 11.2,5	30 181 13.2,5	2,2	40	20	7,2	21	35	22
3,15		30 008 11.2,5	30 008 13.2,5	2,6						
	3,15	30 181 11.3,15	30 181 13.3,15	2,2	40	24	17	32	48	26
4		30 008 11.3,15	30 008 13.3,15	2,6						
	4	30 181 11.4	30 181 13.4	2,2	40	32	31	62	90	33
5		30 008 11.4	30 008 13.4	2,6						
	5	30 181 11.5	30 181 13.5	2,2	40	40	40	80	125	23
		30 008 11.5	30 008 13.5	2,6						



20/36 kV "e" = 442mm / 537 mm

Zeit/Strom-Kennlinie
Time-current characteristic

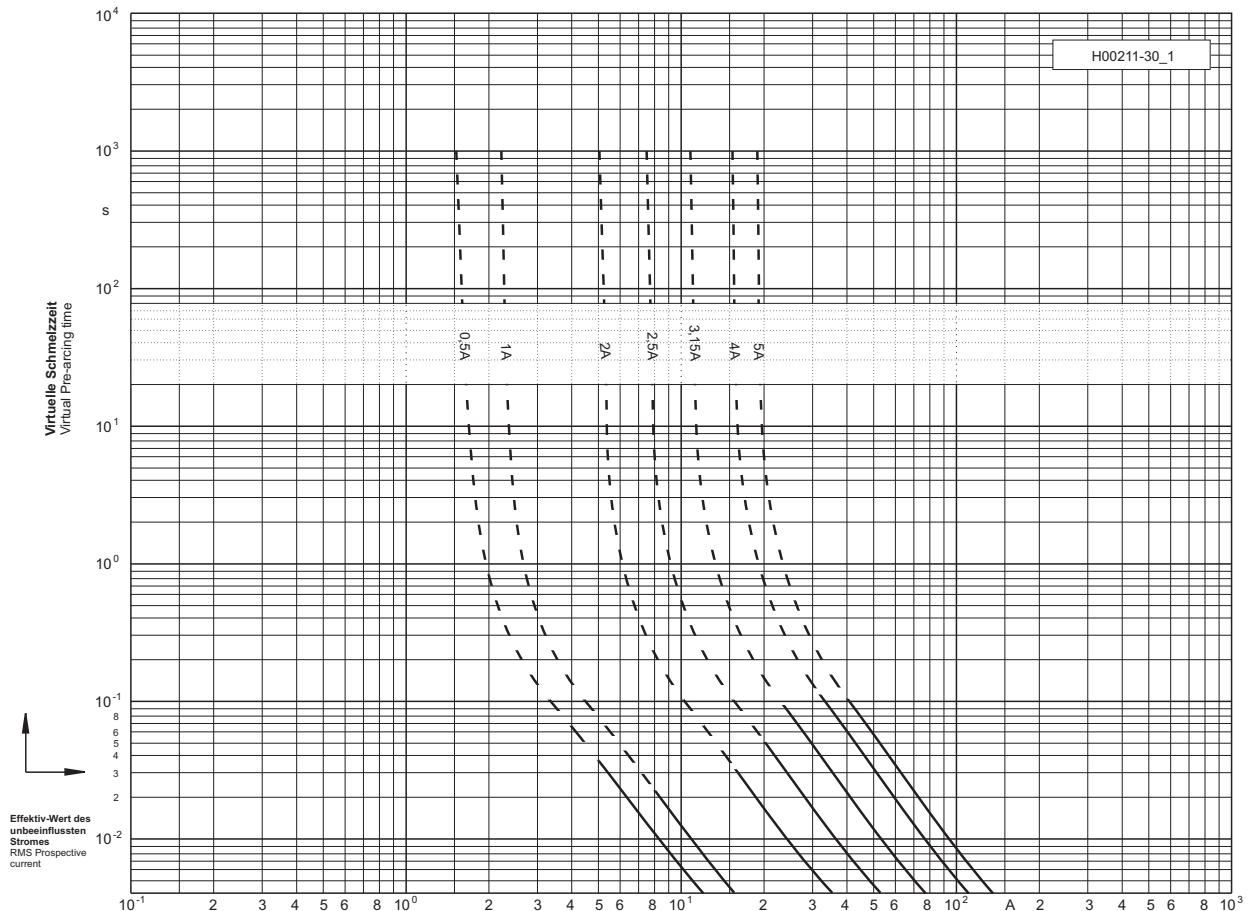

Durchlass-Strom
Cut-off current

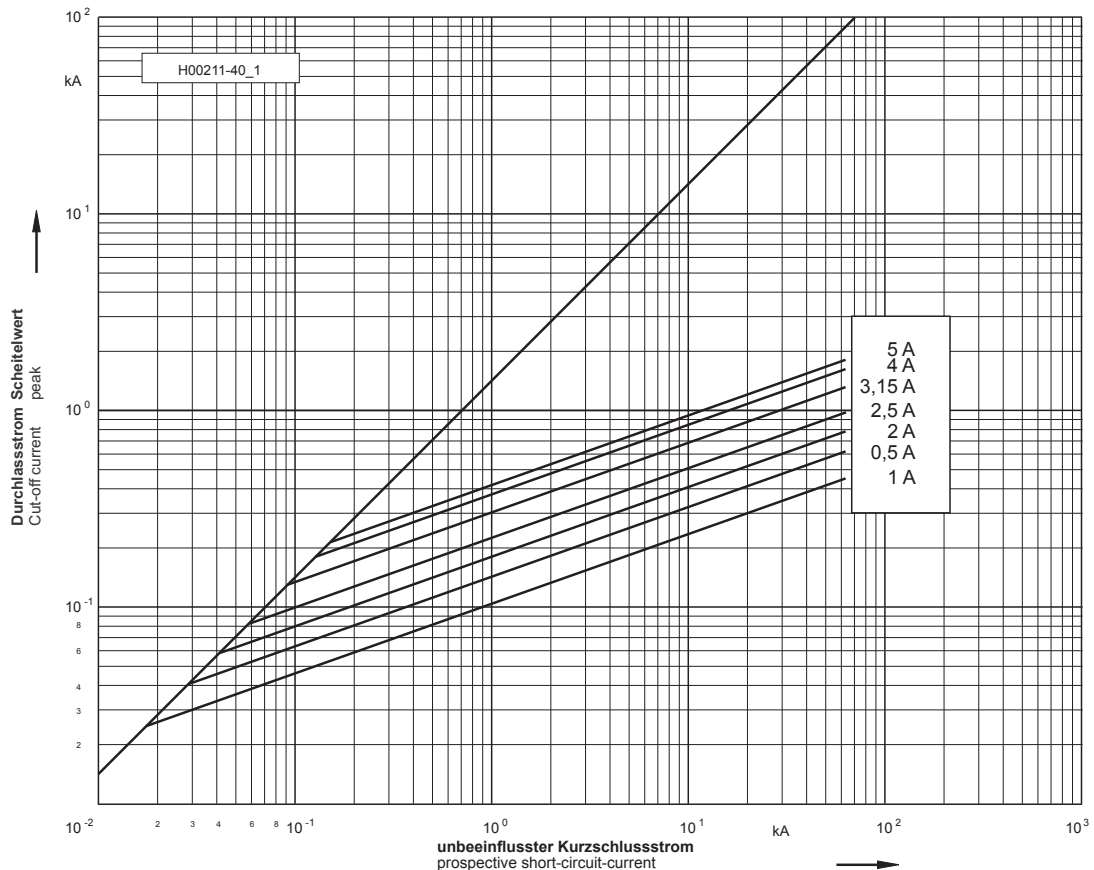

38,5 kV

"e" = 537 mm

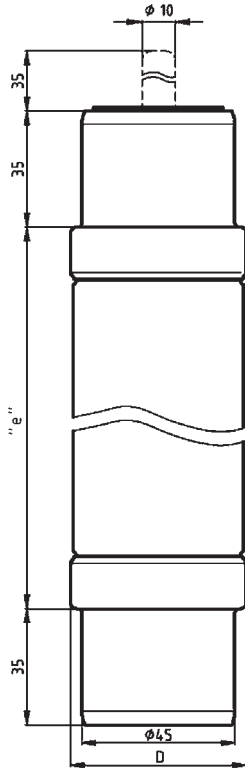

Mit und ohne Schlagstift 80N / With and without striker-pin 80N
Nach DIN 43 625 / Acc. DIN 43 625

Einsatz / Application

Für Innen- und Freiluftanwendungen / Indoor and outdoor application

Verpackung / Packing 1 Stück / 1 piece

Betriebsklasse / Class Teilbereich / Back-up	IEC 60282-1 DIN 43 625	VDE 0670-4
--	---	-------------------

Bemessungs- spannung Rated Voltage	Artikel Article	Bemessungsstrom Rated Current	Länge "e" Length "e"	Durchmesser D Diameter D
kV		A	mm	mm
38,5	30 337 11	0,5 - 5	537	53
	30 337 13	2 - 5	537	

Bemessungs- strom Rated Current	Artikel Nr. Article No.		Gewicht Weight	Bemessungs- ausschaltstrom Rated Breaking Current - I ₁	Minimaler Ausschaltstrom Min. Breaking Current - I ₃	Schmelz- integral Pre- Arcing- I ² t-Value	Ausschaltintegral Total I ² t-Value		Leistungs- abgabe Power Loss	Kaltwider- stand Cold Resistance
	ohne Schlagst. w/o striker pin	mit Schlagstift with striker pin					U _n min	U _n max		
A			kg/1	kA	A	A ² s	A ² s	A ² s	W	mΩ
0,5	30 337 11.0,5	-	2,6	40	5	1,6	3,2	5,9	23	64.800
1	30 337 11.1	-	2,6	40	8	0,63	1,2	1,8	14	10.200
2	30 337 11.2	30 337 13.2	2,6	40	16	3,2	6,5	9,8	25	4.500
2,5	30 337 11.2,5	30 337 13.2,5	2,6	40	20	7,2	21	35	27	3.050
3,15	30 337 11.3,15	30 337 13.3,15	2,6	40	24	17	32	48	30	2.150
4	30 337 11.4	30 337 13.4	2,6	40	32	31	62	90	35	1.550
5	30 337 11.5	30 337 13.5	2,6	40	40	40	80	125	44	1.250

38,5 kV

"e" = 537 mm



Zeit/Strom-Kennlinie
Time-current characteristic

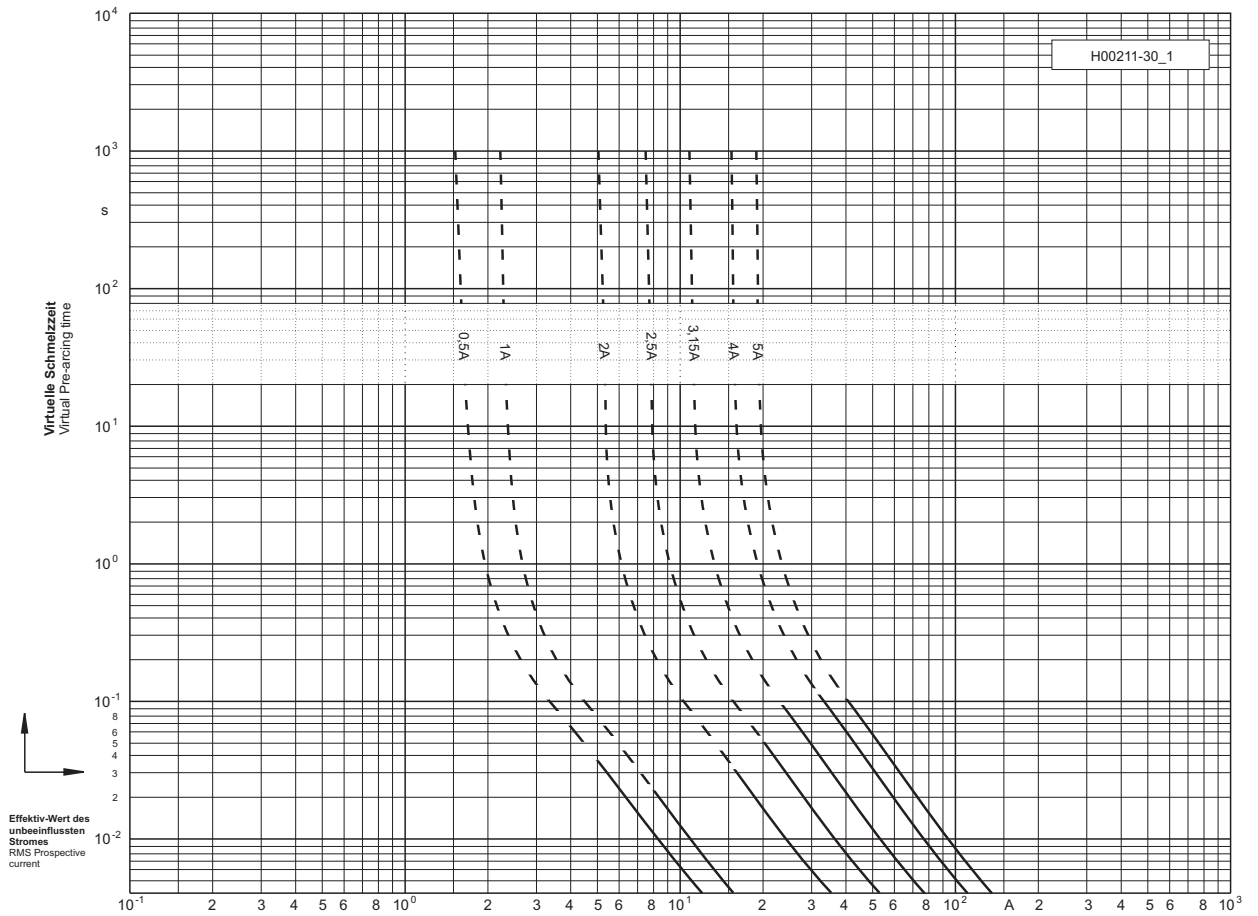

Durchlass-Strom
Cut-off current

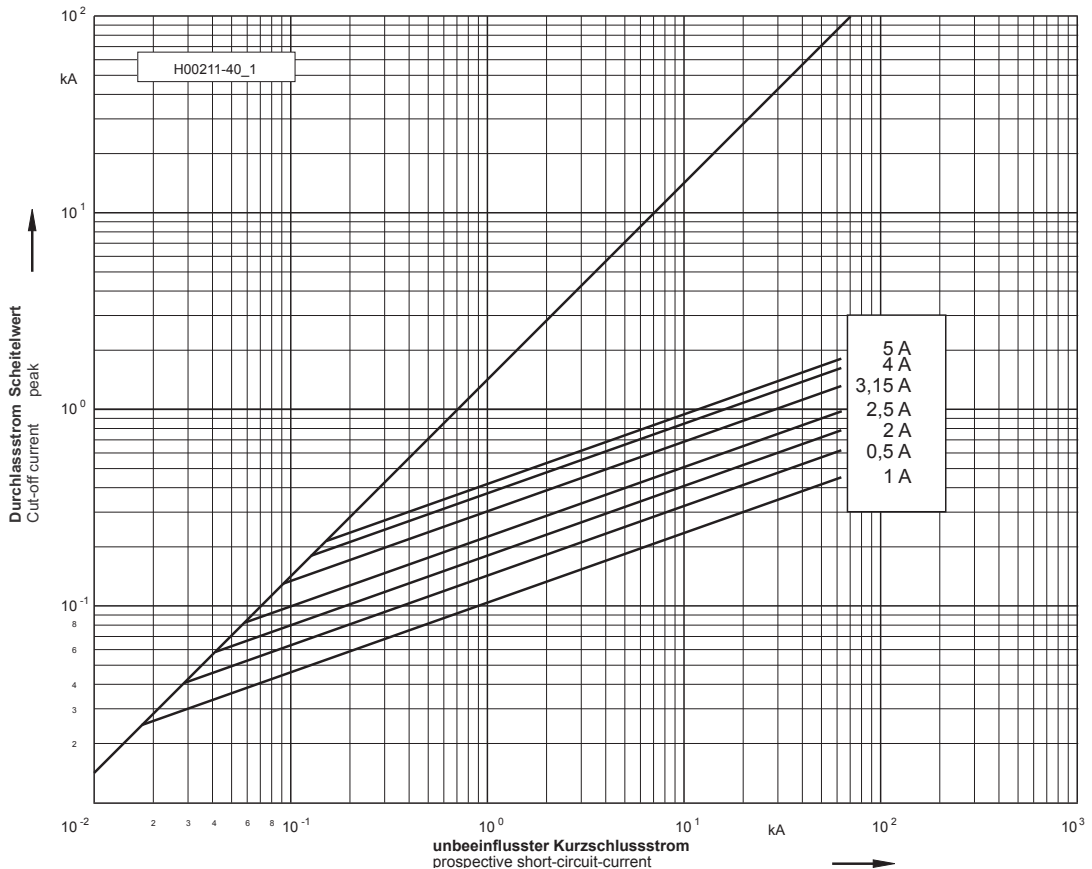

40,5 kV

"e" = 537 mm

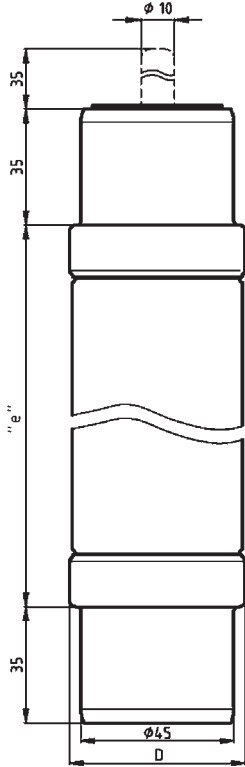

Mit und ohne Schlagstift 80N / With and without striker-pin 80N
Nach DIN 43 625 / Acc. DIN 43 625

Einsatz / Application

Für Innen- und Freiluftanwendungen / Indoor and outdoor application

Verpackung / Packing 1 Stück / 1 piece

Betriebsklasse / Class	IEC 60282-1	VDE 0670-4
Teilbereich / Back-up	DIN 43 625	

Bemessungs- spannung Rated Voltage	Artikel Article	Bemessungsstrom Rated Current	Länge "e" Length "e"	Durchmesser D Diameter D
kV		A	mm	mm
40,5	30 340 11	0,5 - 5	537	53
	30 340 13	2 - 5	537	

Bemessungs- strom Rated Current	Artikel Nr. Article No.		Gewicht Weight	Bemessungs- ausschaltstrom Rated Breaking Current - I ₁	Minimaler Ausschaltstrom Min. Breaking Current - I ₃	Schmelz- integral Pre- Arcing- I ² t-Value	Ausschaltintegral Total I ² t-Value		Leistungs- abgabe Power Loss	Kaltwider- stand Cold Resistance
	ohne Schlagst. w/o striker pin	mit Schlagstift with striker pin					U _n min	U _n max		
A			kg/1	kA	A	A ² s	A ² s	A ² s	W	mΩ
0,5	30 340 11.0,5	-	2,6	40	5	1,6	3,2	5,9	24	68.200
1	30 340 11.1	-	2,6	40	8	0,63	1,2	1,8	15	10.800
2	30 340 11.2	30 340 13.2	2,6	40	16	3,2	6,5	9,8	27	4.800
2,5	30 340 11.2,5	30 340 13.2,5	2,6	40	20	7,2	21	35	28	3.250
3,15	30 340 11.3,15	30 340 13.3,15	2,6	40	24	17	32	48	32	2.270
4	30 340 11.4	30 340 13.4	2,6	40	32	31	62	90	36	1.620
5	30 340 11.5	30 340 13.5	2,6	40	40	40	80	125	47	1.340



40,5 kV

"e" = 537 mm

Zeit/Strom-Kennlinie
Time-current characteristic

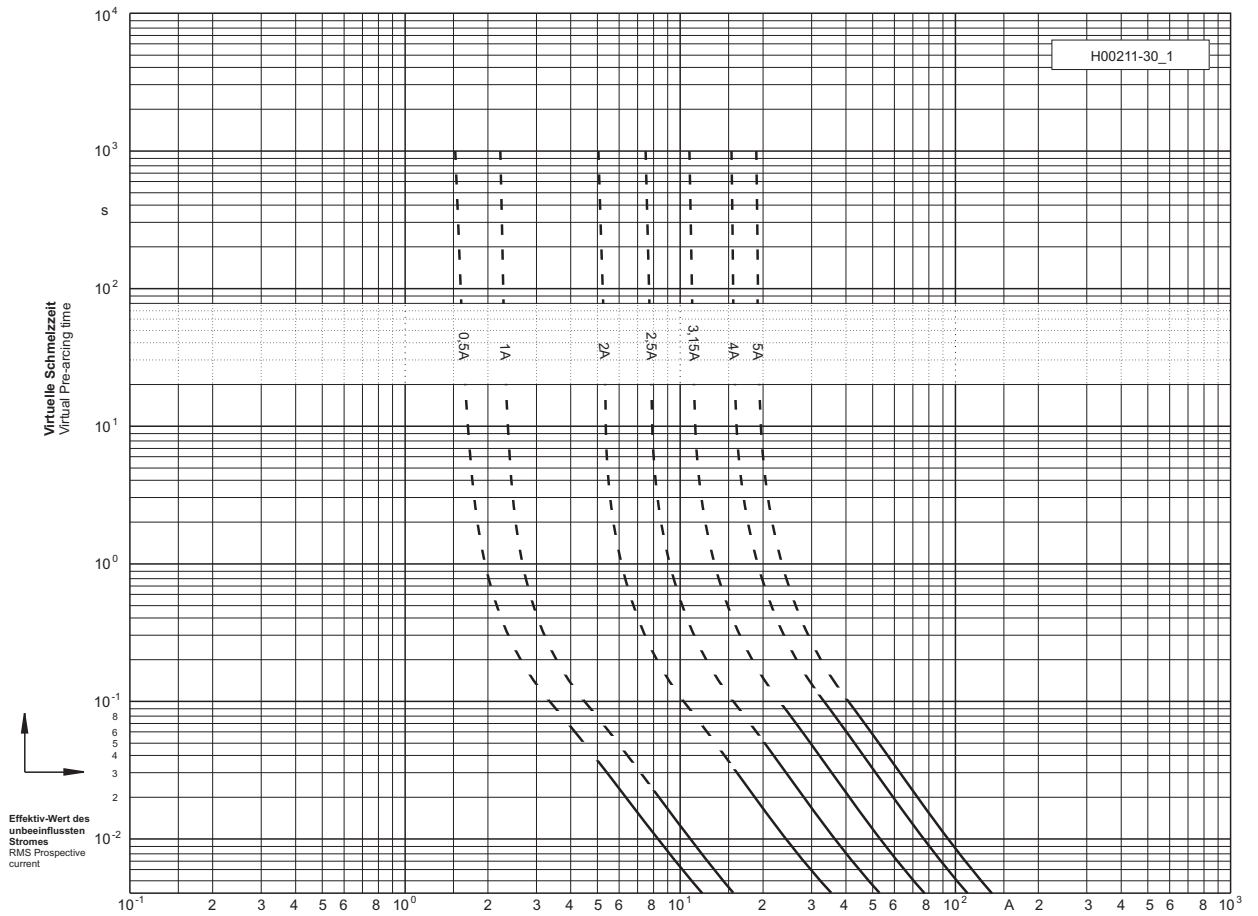

Durchlass-Strom
Cut-off current

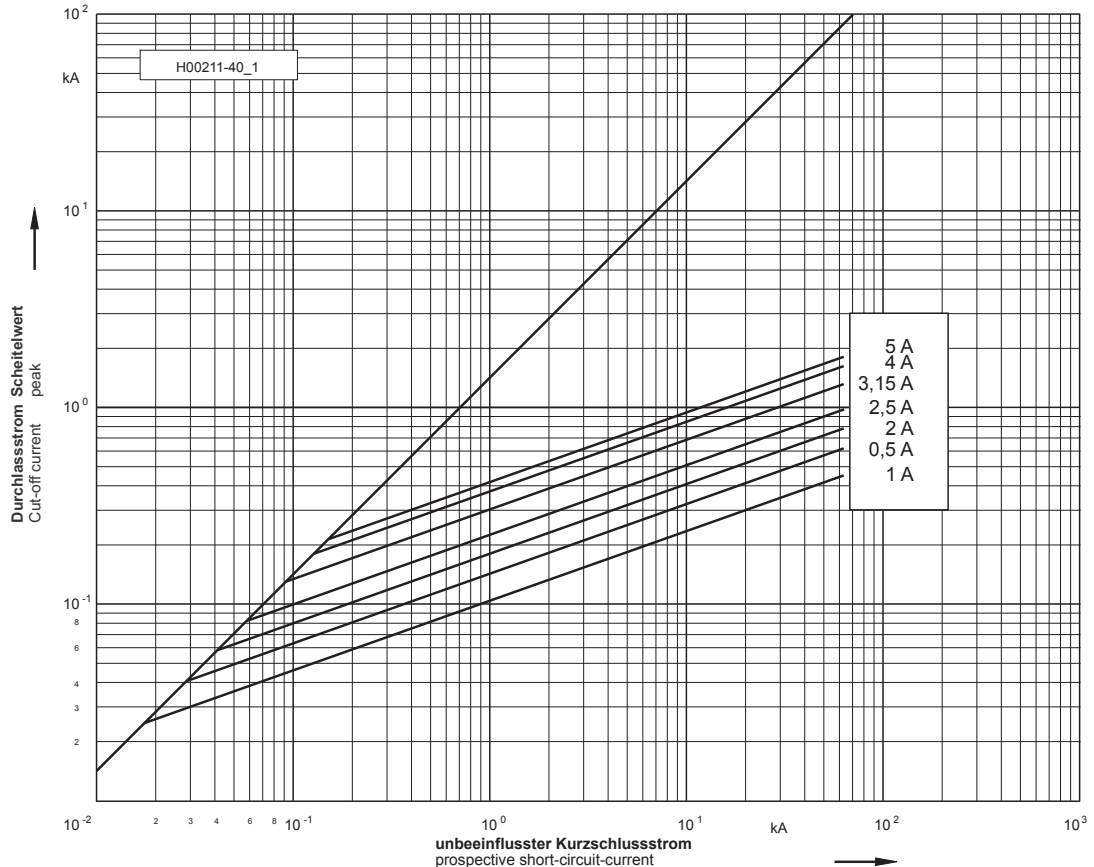

7,2-36kV

**HH-Sicherungsunterteile für Innenraumanlagen
HV Fuse-Bases for Indoor Application**

Standard : DIN 43624
Bemessungsstrom : 200 A

Grundplatte : Profilstahl,
dickschicht passiviert

Stützer : Gießharz

Kontakte : E-Cu-Legierung, vernickelt,
mit Edelstahl-Bügel

Standard : DIN 43624

Rated current : 200 A

Bases plate : structural steel,
thickfilm passivated

Insulators : casr resin

Contacts : E-Cu alloy, nickel-plated,
with clamping bow

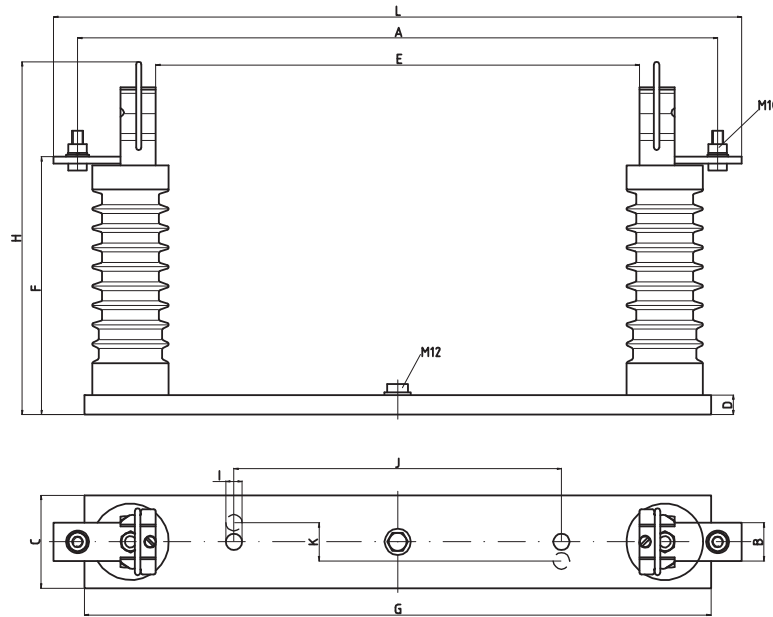

	Bezmessungsspannung Rated Voltage	Bemessungsspannung Rated Voltage	Bemessungsspannung Rated Voltage	Bemessungsspannung Rated Voltage	Bemessungsspannung Rated Voltage	Bemessungsspannung Rated Voltage
	7,2 kV	12 kV	12 kV	24 kV	17,5/24 kV	36 kV
	"e" = 192 mm	"e" = 292 mm	"e" = 442 mm	"e" = 442 mm	"e" = 292 mm	"e" = 537 mm
	Artikel Nr. / Article No. 31 001 02	Artikel Nr. / Article No. 31 003 02	Artikel Nr. / Article No. 31 101 02	Artikel Nr. / Article No. 31 005 02	Artikel Nr. / Article No. 31 221 01	Artikel Nr. / Article No. 31 007 02
A	350 mm	450 mm	600 mm	600 mm	450 mm	695 mm
B	35 mm	35 mm	35 mm	35 mm	35 mm	35 mm
C	85 mm	85 mm	85 mm	85 mm	85 mm	85 mm
D	18 mm	18 mm	18 mm	18 mm	18 mm	18 mm
E	193 mm	293 mm	443 mm	443 mm	293 mm	538 mm
F	157 mm	157 mm	157 mm	237 mm	237 mm	327 mm
G	310 mm	410 mm	574 mm	574 mm	410 mm	676 mm
H	243 mm	243 mm	243 mm	323 mm	323 mm	413 mm
I	15 mm	15 mm	15 mm	15 mm	15 mm	15 mm
J	55 mm	180 mm	300 mm	300 mm	180 mm	380 mm
K	35 mm	0 mm	0 mm	0 mm	0 mm	0 mm
L	380 mm	480 mm	630 mm	630 mm	480 mm	725 mm

Bei/at $I_{n\text{ sich}} \geq 200 \text{ A} = 31 \dots 06$ (verstärkte Kontakte/reinforced contacts)

7,2-40,5kV

**HH-Sicherungsunterteile für Freiluftanlagen
HV Fuse-Bases for Outdoor Application**

Standard : DIN 43624
 Bemessungsstrom : 200 A
 Grundplatte : Profilstahl, verzinkt
 Stützer : Gießharz
 Kontakte : E-Cu-Legierung, vernickelt,
 mit Edelstahl-Bügel

Standard : DIN 43624
 Rated current : 200 A
 Bases plate : structural steel, zinc-plated
 Insulators : casr resin
 Contacts : E-Cu alloy, nickel-plated,
 with clamping bow

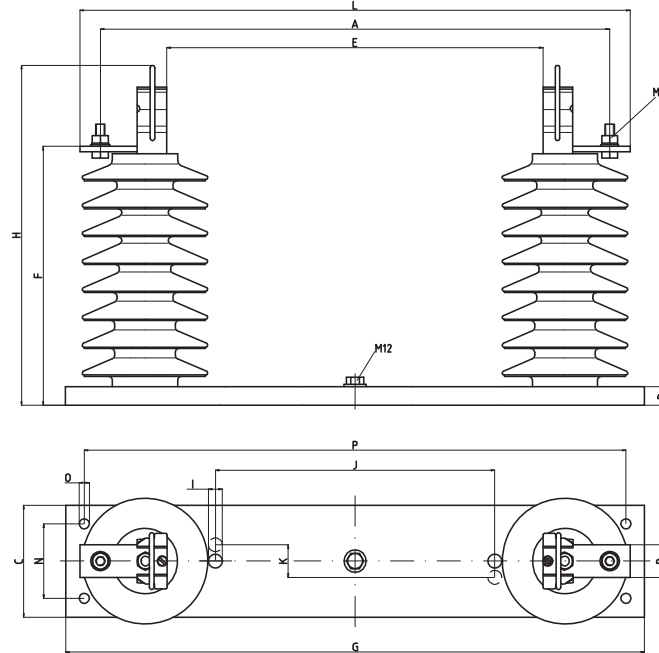

	Bemessungs- spannung Rated Voltage	Bemessungs- spannung Rated Voltage	Bemessungs- spannung Rated Voltage	Bemessungs- spannung Rated Voltage	Bemessungs- spannung Rated Voltage
	7,2 kV	12 kV	24 kV	36 kV	40,5 kV
	"e" = 192 mm	"e" = 292 mm	"e" = 442 mm	"e" = 537 mm	"e" = 537 mm
	Artikel Nr. / Article No. 31 002 01	Artikel Nr. / Article No. 31 004 01	Artikel Nr. / Article No. 31 006 01	Artikel Nr. / Article No. 31 008 01	Artikel Nr. / Article No. 31 340 01
A	350 mm	450 mm	600 mm	695 mm	695 mm
B	35 mm	35 mm	35 mm	35 mm	35 mm
C	120 mm	120 mm	120 mm	120 mm	120 mm
D	20 mm	20 mm	20 mm	20 mm	20 mm
E	193 mm	293 mm	444 mm	538 mm	538 mm
F	239 mm	239 mm	279 mm	389 mm	529 mm
G	410 mm	510 mm	660 mm	785 mm	785 mm
H	325 mm	325 mm	365 mm	475 mm	615 mm
I	15 mm	15 mm	15 mm	15 mm	15 mm
J	55 mm	180 mm	300 mm	380 mm	380 mm
K	35 mm	0 mm	0 mm	0 mm	0 mm
L	380 mm	480 mm	630 mm	725 mm	725 mm
N	80 mm	80 mm	80 mm	80 mm	80 mm
O	11 mm	11 mm	11 mm	11 mm	11 mm
P	370 mm	470 mm	620 mm	745 mm	745 mm

Bei/at $I_{n\text{ sich}} \geq 200\text{ A} = 31 \dots 06$ (verstärkte Kontakte/reinforced contacts)

Prüfsicherungseinsatz mit zeitverzögerter Auslösung / Test-Fuse with Time Delayed Release

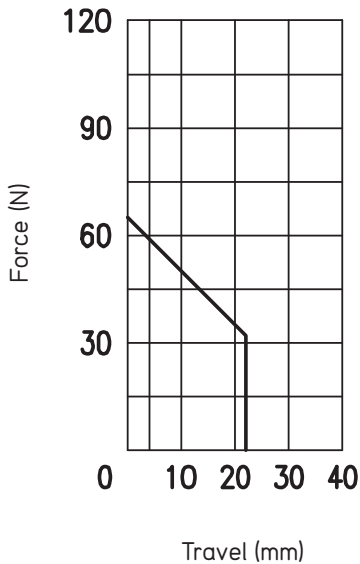

Zur Prüfung der Auslösemechanik in gekapselten Mittelspannungs-Schaltanlagen

For testing the release mechanism in enclosed medium voltage switchgear

**Zur Anpassung des Maßes "e" ist ein Adapter verfügbar
von 192 mm auf 292 mm = Artikel Nr. 34 004 02
von 192 mm auf 442 mm = Artikel Nr. 34 006 02**

To change "e" an adaptor is available
from 192 mm to 292 mm = Article no. 34 004 02
from 192 mm to 442 mm = Article no. 34 006 02

	Artikel Nr. / Article No.
	33 010 03
A	45 mm
D	70 mm
E	192 mm
F	34 mm
G	8 mm
H	27 mm
L	260 mm

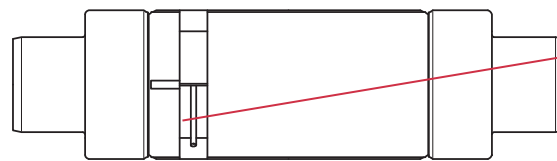

Spannhebel für Zeitschaltwerk / Clamp lever for timer

Auslösezeit ca. 100 s
Release time approx. 100 s

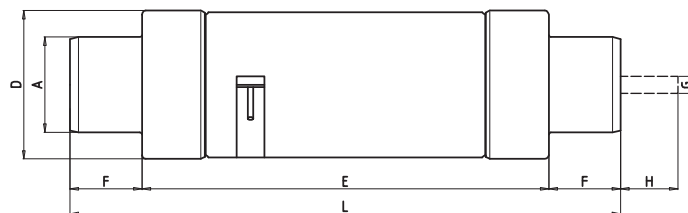

24 kV

24 kV Verlängerungsadapter für HH-Sicherungseinsätze 12 kV /
24 kV Extension Adapter for High-Voltage Fuses 12kV

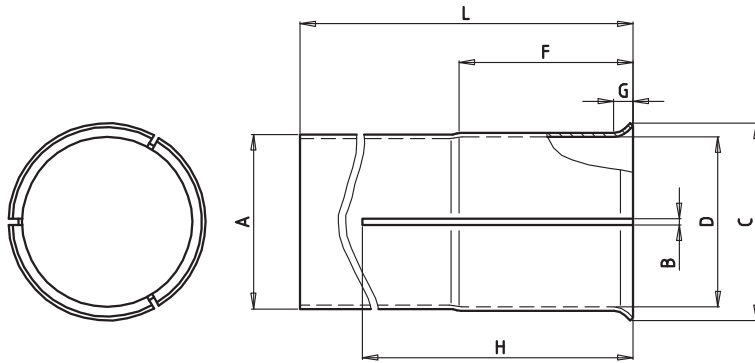

	Artikel Nr. / Article No. 34 006 01
A	45 mm
B	1,5 mm
C	51 mm
D	44 mm
F	45 mm
G	5 mm
H	70 mm
L	185 mm

24 kV

HH-Sicherungseinsätze mit 24 kV Verlängerungsadapter /
HV-Fuses with 24 kV Extension Adapter

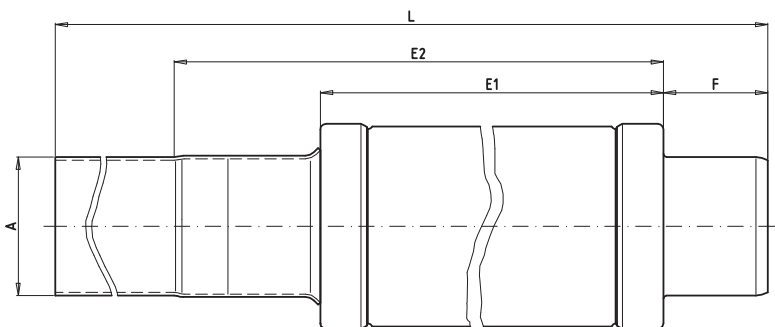

A	45 mm
E1	292 mm
E2	442 mm
F	33 mm
L	503 mm

Hilfsschalter-Anbau an Hochspannungs-Sicherungsunterteile Micro Switch Fitting to High-Voltage Fuse-Bases

Hilfsschalter / Micro Switch
Artikel Nr. / Article No.
28 001 04
250 V / 6 A
1 Wechselkontakt
1 Change over Contact
inklusive / included



Flexibler Bowdenzug
Flexible Bowden Cable

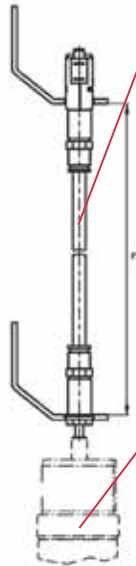

HH-Sicherungs-Kappe
HV Fuse-Cap

L	Artikel Nr. / Article No.
660 mm	31 001 10
400 mm	31 001 13
970 mm	31 001 14
250 mm	31 001 16
1200 mm	31 001 17
600 mm	31 002 10
970 mm	31 003 14

Zur Verwendung unter Öl / for use under oil

L	Artikel Nr. / Article No.
660 mm	31 002 10

Produkt besteht aus:
Flexiblen Bowdenzug und Hilfsschalter
Art.-Nr. 28 001 04

Product consists of:
Flexiblen Bowden Cable
and Micro Switch
Art.- No. 28 001 04

Der SIBA-Hilfsschalteranbau für HH-Sicherungsunterteile erlaubt die Überwachung des Schaltzustandes von HH-Sicherungseinsätzen. Dabei wird die Bewegung des Sicherungsschlagstiftes über einen isolierten Bowdenzug an einen Mikroschalter weitergeleitet. Der Mikroschalter selbst ist als Umschalter für Schaltungen bis 250 V AC, 6 A konzipiert.

Das Einbauzubehör dieses Anbaus ist auf die Schraublöcher der SIBA-HH-Sicherungssockel abgestimmt. Daher sind bei der Installation dieser Hilfsschaltersysteme oder auch bei einem nachträglichen Anbau keine weiteren Bohrungen notwendig. Eine Anpassung an die Sicherungsunterteile anderer Hersteller ist jedoch möglich. Außerdem kann das Set auch dann eingesetzt werden, wenn nur die SIBA Federkontakte mit der Artikel-Nr. 34 002 01 und kein kompletter Sicherungssockel eingesetzt werden.

Abhängig von der Betriebsspannung des HH-Sicherungseinsatzes kann der Mikroschalter in einem Höchstabstand „L“ von der Sicherung entfernt montiert werden. Dabei ist eine Mindestkrümmung des flexiblen Bowdenzugs von 250 mm einzuhalten.

Falls lediglich die Kontaktfeder (Artikel-Nr. 31 003 02.20, siehe Katalog Seite 113) eingesetzt wird, muss zusätzlich das Distanzstück (Artikel-Nr. 31 002 01.3, Seite 114) montiert werden.

The SIBA microswitch installation set for high-voltage fuse-bases, allows supervision of the switching status of high-voltage fuse-links. By means of a flexible bowden drive, the movement of the fuse-link striker will be transferred to a microswitch. The microswitch itself has a change over contact and is suitable for 250 V AC, 6 A.

The fitting accessories of this installation set match with the bolting holes of SIBA high-voltage fuse-bases. Therefore, when such microswitch systems are added to SIBA high-voltage fuse-bases later on, no additional drillings have to be done. Adaption to fuses-bases of other manufacturers is, however, possible. Furthermore, the set can also be fitted if only SIBA spring clip contacts article no. 34 002 01 are used, and not a complete fuse-base.

Depending on the service voltage of the high-voltage fuse-link, the microswitch can be fitted within a maximum distance of "L" from the fuse-link. A minimum radius of the flexible bowden drive of 250 mm has to be observed.

If the panel builder only uses the spring clip contact (article no. 31 003 02.20, see catalogue page 113), the spacer (article no. 31 002 01.3, page 114) must be used.

≤ 200 A*

HH-Kontaktarmatur für Innenraum- und Freiluftanlagen / HV-Contact Clip for Indoor and Outdoor Application

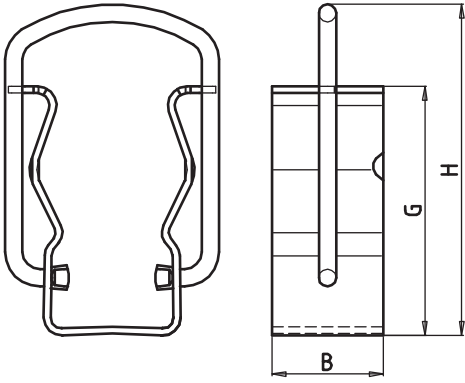

	Artikel Nr. / Article No. 31 003 02.20
B	32 mm
G	71,5 mm
H	95 mm

> 200 A*

HH-Kontaktarmatur für Innenraum- und Freiluftanlagen / HV-Contact Clip for Indoor and Outdoor Application

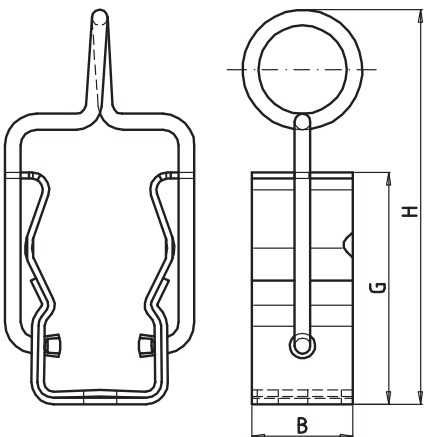

	Artikel-Nr. / Article No. 34 001 01.20
B	32 mm
G	73,5 mm
H	125 mm

* Bemessungsstrom des Sicherungseinsatzes; Grenztemperatur (105°C) bzw. Erwärmung (65K) des Kontaktes beachten.
rated current of the fuse-link. Please observe limit temperature (105 degrees Celsius) and warming-up of contact (65 K).

≤ 200 A*

HH-Federkontakt mit Anschlusslasche /
HV-Spring Clip Contact with Connection Bar

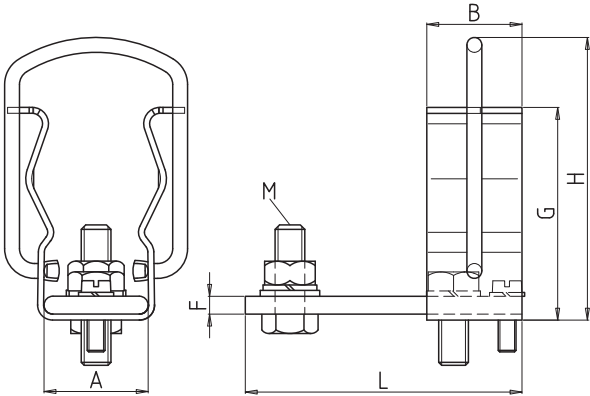

	Artikel Nr. / Article No. 34 002 01
A	35 mm
B	32 mm
F	6 mm
G	71,5 mm
H	95 mm
L	93 mm
M	M10

> 200 A*

HH-Federkontakt mit Anschlusslasche /
HV-Spring Clip Contact with Connection Bar

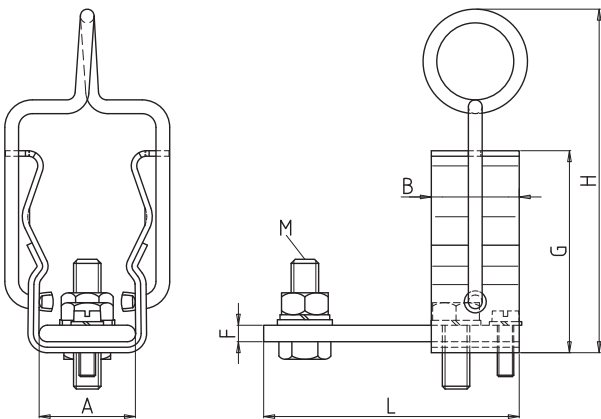

	Artikel Nr. / Article No. 34 001 02
A	35 mm
B	32 mm
F	6 mm
G	73,5 mm
H	125 mm
L	93 mm
M	M10

Distanzstück /
Spacer

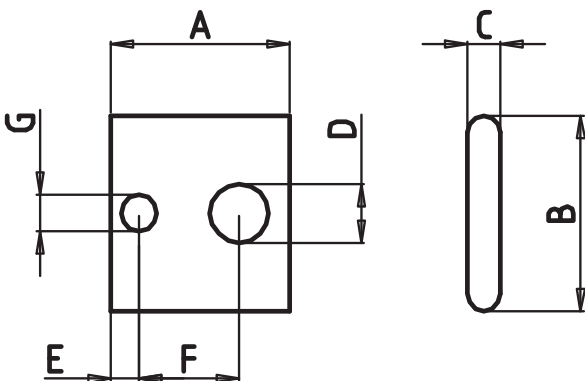

	Artikel Nr. / Article No. 31 002 01.3
A	32 mm
B	35 mm
C	6 mm
D	10,5 mm
E	5 mm
F	18 mm
G	6,5 mm

* Bemessungsstrom des Sicherungseinsatzes; Grenztemperatur (105°C) bzw. Erwärmung (65K) des Kontaktes beachten.
rated current of the fuse-link. Please observe limit temperature (105 degrees Celsius) and warming-up of contact (65 K).

12-36 kV

Vorratshalter für HHD- und NH-Sicherungseinsätze
Storage Holder for HV- and LV Fuse-Links

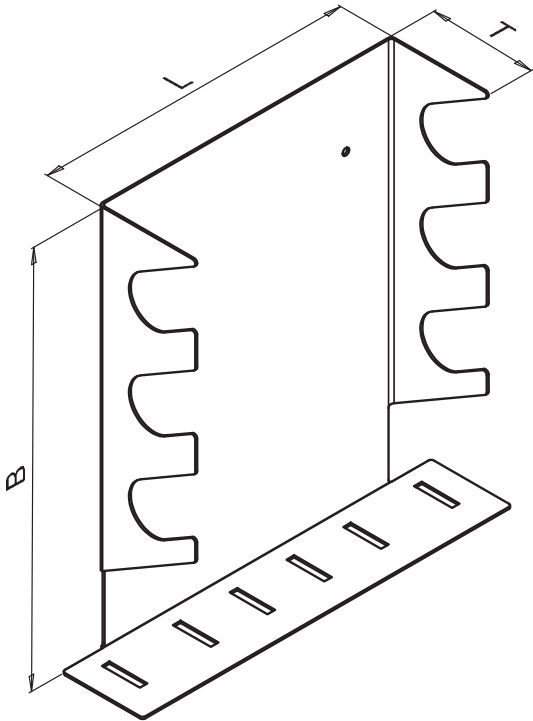

Bemessungsspannung Rated Voltage	Artikel Nr. Article No.	HH-Sicherungen HV-Fuses	NH-Sicherungen LV-Fuses	L	B	T	Gewicht Weight
kV		Stück / Pieces	Stück / Pieces	mm	mm	mm	kg/1
12 (e=292 mm)	33 004 01	3	6 x NH 2	304	408	105	1,0
24 (e=442 mm)	33 006 01	3	6 x NH 2	454	408	105	1,4
36 (e=537 mm)	33 008 01	3	6 x NH 2	550	408	105	1,9

30 kV

Einschenkklige Einsatzzange für HH-Sicherungseinsätze
Single-leg Insertion Tongs for HV Fuse-Links

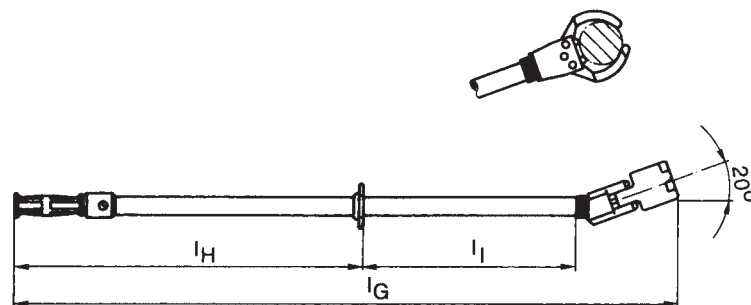

Artikel Nr. Article No.	Nennspannung Rated voltage	Abmessung / Dimensions			Gewicht Weight
		l _G	l _I	l _H	
DIN 57 681, VDE 0681		mm	mm	mm	kg
32 005 26	30 kV	1250	525	540	2,0

„Bei Niederschlägen nicht verwenden.“
„not to be used under wet conditions.“

