

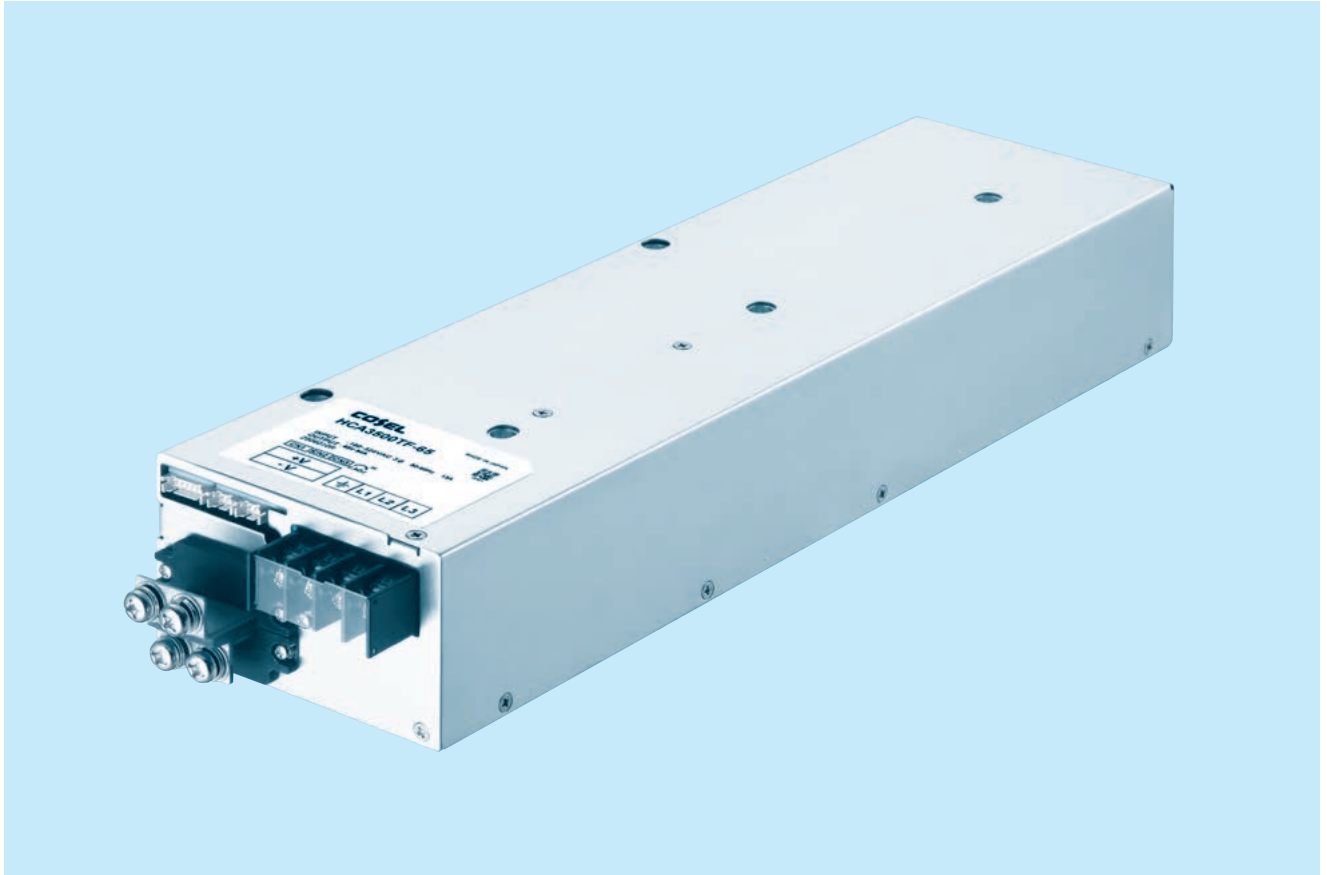

HCA-series



■ Feature

- Fanless (Conduction cooling)
- Low profile (Meets 1.5U height.)
- Wide input voltage range
- High efficiency
- Parallel Operation / N+1 Parallel Redundancy Operation
- Built-in AUX (12V1A)
- Built-in Alarms
- Remote ON / OFF function

■ Safety agency approvals

UL62368-1, C-UL (CSA62368-1), EN62368-1

■ 5-year warranty (Refer to Instruction Manual)

■ CE marking

Low voltage Directive
RoHS Directive

■ UKCA marking

Electrical Equipment Safety Regulations
RoHS Regulations

■ EMI

Complies with FCC Part 15-A, CISPR32-A, EN55011-A,
EN55032-A, VCCI-A

■ EMS Compliance : EN61204-3, EN61000-6-2

EN61000-4-2
EN61000-4-3
EN61000-4-4
EN61000-4-5
EN61000-4-6
EN61000-4-8
EN61000-4-11

HCA3500TF

HC A 3500 TF -□□ -□

① ② ③ ④ ⑤ ⑥

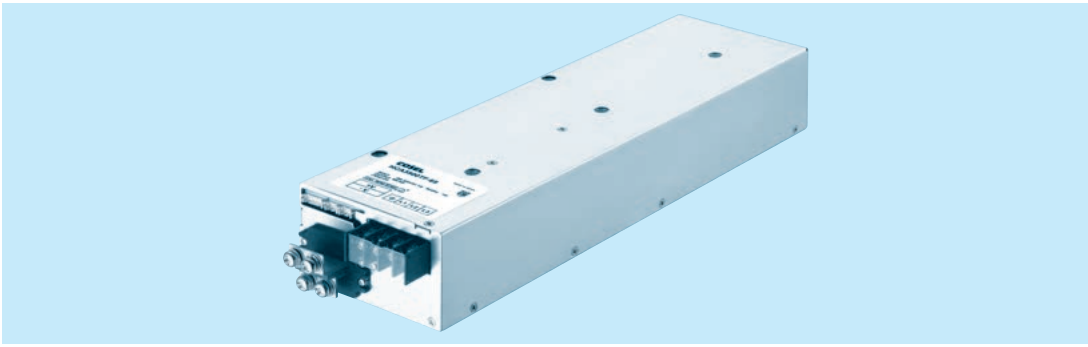

- ① Series name
- ② Single output
- ③ Output wattage
- ④ 3 phase full range input
- ⑤ Output voltage
- ⑥ Optional
- R : with Remote ON/OFF
Positive logic control
- G : Low leakage current
- T1: Different shaped output terminal

MODEL	HCA3500TF-48	HCA3500TF-65
MAX OUTPUT WATTAGE[W]	3504	3510
DC OUTPUT	48V 73A	65V 54A

SPECIFICATIONS

	MODEL	HCA3500TF-48	HCA3500TF-65	
INPUT	VOLTAGE[VAC]	*1 180 - 528 3 φ 3-wire (Available to 3 φ 4-wire as well (without N phase))		
	CURRENT[A]	ACIN 200V	11.5typ	
		ACIN 400V	5.7typ	
	FREQUENCY[Hz]	50 / 60 (45 - 66)		
	EFFICIENCY[%]	ACIN 200V (Io=100%)	91typ	92typ
		ACIN 400V (Io=100%)	93typ	94typ
	POWER FACTOR	ACIN 200V (Io=100%)	0.95typ	
		ACIN 400V (Io=100%)	0.94typ	
INRUSH CURRENT[A]	ACIN 200V *2	20 / 30 typ (Io=100%) (Primary / Secondary inrush current) (More than 3 sec. to re-start)		
	ACIN 400V *2	40 / 30 typ (Io=100%) (Primary / Secondary inrush current) (More than 3 sec. to re-start)		
LEAKAGE CURRENT[mA]	3 max (ACIN 480V 60Hz, Io=100%, Complies with IEC62368-1)			
OUTPUT	VOLTAGE[V]	48	65	
	CURRENT[A]	73	54	
	LINE REGULATION[mV]	192max	260max	
	LOAD REGULATION[mV]	300max	450max	
	RIPPLE[mVp-p]	*3 480max	650max	
	RIPPLE NOISE[mVp-p]	*3 720max	950max	
	TEMPERATURE REGULATION[mV]	480max	650max	
	START-UP TIME[ms]	400 typ (ACIN 200/400V, Io=100%)		
	HOLD-UP TIME[ms]	20 typ (ACIN 200V, Io=55%) / 10 typ (ACIN 200V, Io=100%)		
	OUTPUT VOLTAGE ADJUSTMENT RANGE[V] *4		33.60 to 55.20	45.50 to 74.75
OUTPUT VOLTAGE SETTING[V]		48.00 to 48.48	65.00 to 65.65	
PROTECTION CIRCUIT AND OTHERS	OVERCURRENT PROTECTION	Works over 105% of rating (Recovers automatically, Hiccup overcurrent)		
	OVERVOLTAGE PROTECTION[V]	59.04 to 67.20	79.95 to 91.00	
	Remote sensing	Provided		
	REMOTE ON/OFF	Provided		
	DC_OK LAMP	LED (Blue)		
ALARM LAMP	LED (Amber)			
ISOLATION	Input - Output, CN1, CN2, CN3	4,243VAC 1minute, Cutoff current = 15mA, 500VDC 50MΩ min (At room temperature)		
	Input - FG	2,829VAC 1minute, Cutoff current = 15mA, 500VDC 50MΩ min (At room temperature)		
	Output, CN1, CN2 - FG	2,000VAC 1minute, Cutoff current = 10mA, 500VDC 50MΩ min (At room temperature)		
	Output, CN1, CN2 - CN3	500VAC 1minute, Cutoff current = 10mA, 500VDC 50MΩ min (At room temperature)		
	CN3 - FG	500VAC 1minute, Cutoff current = 10mA, 500VDC 50MΩ min (At room temperature)		
ENVIRONMENT	OPERATING TEMP.,HUMID.AND ALTITUDE	0 to +55°C (Baseplate temperature), -10 to +70°C (Ambient temperature), 20 - 90%RH (Non condensing), 3,000m (10,000feet) max		
	STORAGE TEMP.,HUMID.AND ALTITUDE	-20 to +75°C, 20 - 90%RH (Non condensing), 9,000m (30,000 feet) max		
	VIBRATION	10 - 55Hz, 19.6m/s ² (2G), 3minutes period, 60minutes each along X, Y and Z axis		
	IMPACT	196.1m/s ² (20G), 11ms, once each along X, Y and Z axis		
SAFETY AND NOISE REGULATIONS	AGENCY APPROVALS	UL62368-1, EN62368-1, C-UL (equivalent to CAN/CSA-C22.2 No.62368-1)		
	CONDUCTED NOISE	Complies with FCC Part 15-A, FCC Part18-A, CISPR11-A, CISPR32-A, EN55011-A, EN55032-A, VCCI-A		
OTHERS	CASE SIZE/WEIGHT	110 X 65 X 420mm [4.33 X 2.65 X 16.54 inches] (without terminal block and screw) (W X H X D) / 5kg max		
	COOLING METHOD	Conduction cooling (Water-cooled)		

*1 Output derating is required at 180 - 200VAC. Refer to "Derating".
 *2 The value is primary surge. The current of input surge to a built-in EMI/EMS Filter (0.2ms or less) is excluded.
 *3 Measured by 20MHz oscilloscope or Ripple-Noise meter (equivalent to KEISOKUGIKEN : RM104). Please refer to the instruction manual 1.7.
 *4 Output derating is required more than 52.8V (HCA3500TF-48) / 71.5V (HCA3500TF-65). Refer to "Derating"

Features

- Fanless (Conduction cooling)
- Low profile (65mm, 2.65 inch = Meet 1.5U height)
- Wide input voltage range : 3 φ 180–528VAC
- Built-in AUX power 12V 1A

- Parallel Operation / N+1 Parallel Redundancy Operation
- High efficiency 94% (at 400VAC input and 65V output)
- Built-in Alarms
- Built-in Oring MOSFET

Block diagram

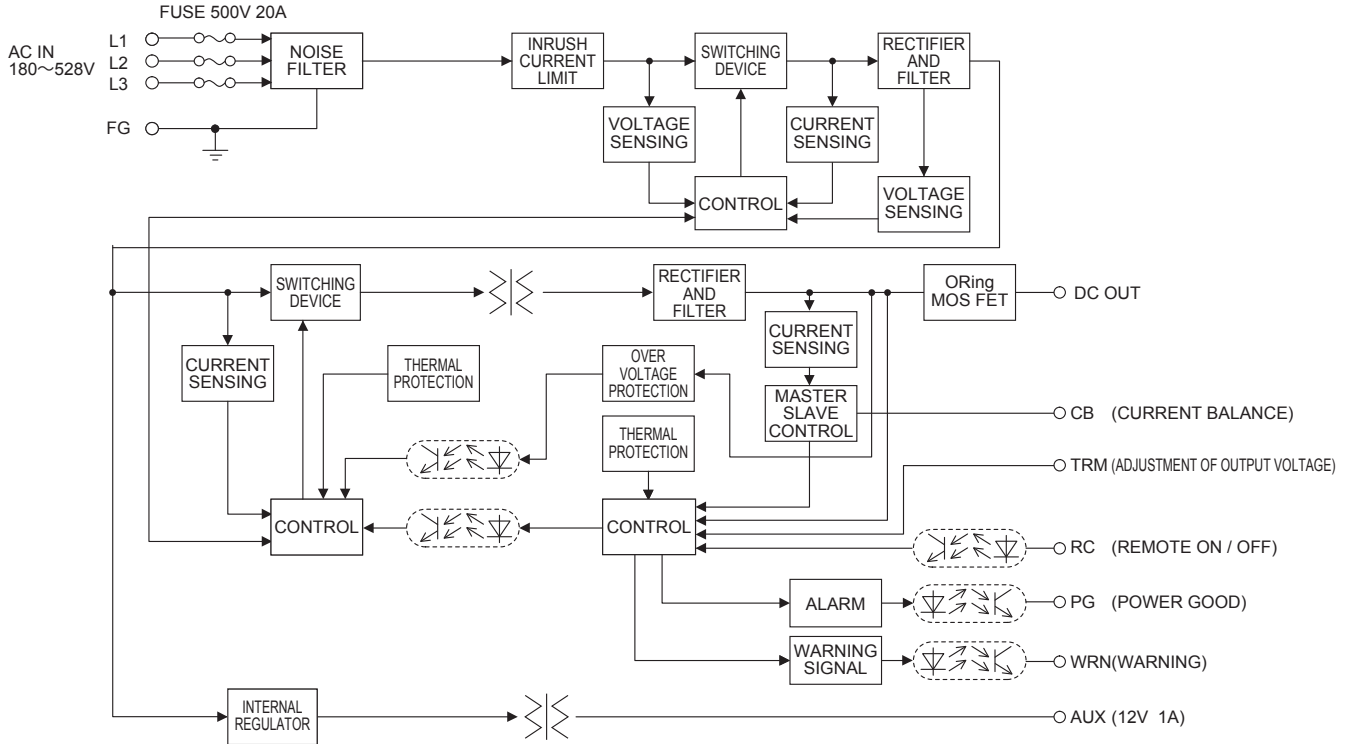

External view

1. Standard model

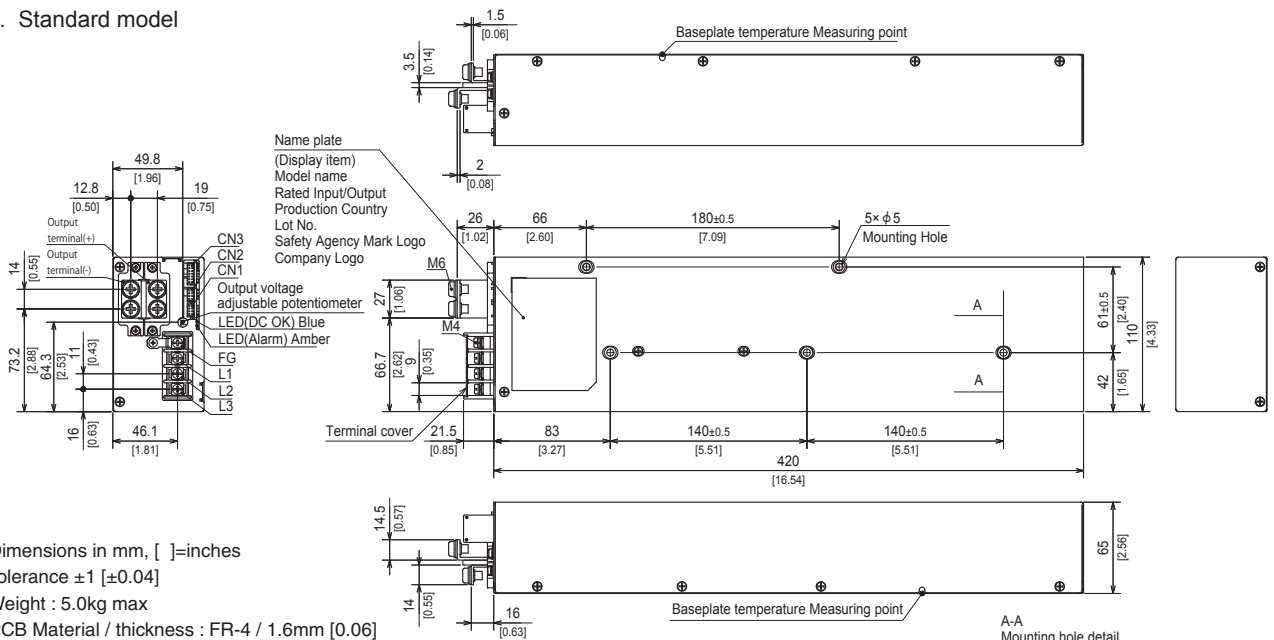

* Dimensions in mm, []=inches

* Tolerance ± 1 [± 0.04]

* Weight : 5.0kg max

* PCB Material / thickness : FR-4 / 1.6mm [0.06]

* Chassis Material : Stainless

* Baseplate Material : Alminum

* Input and output terminal screw tightening torue
: M4 1.6N · m max
M6 4.3N · m max

* Please connect safety ground to FG terminal on the unit.

External view

2. T1 model

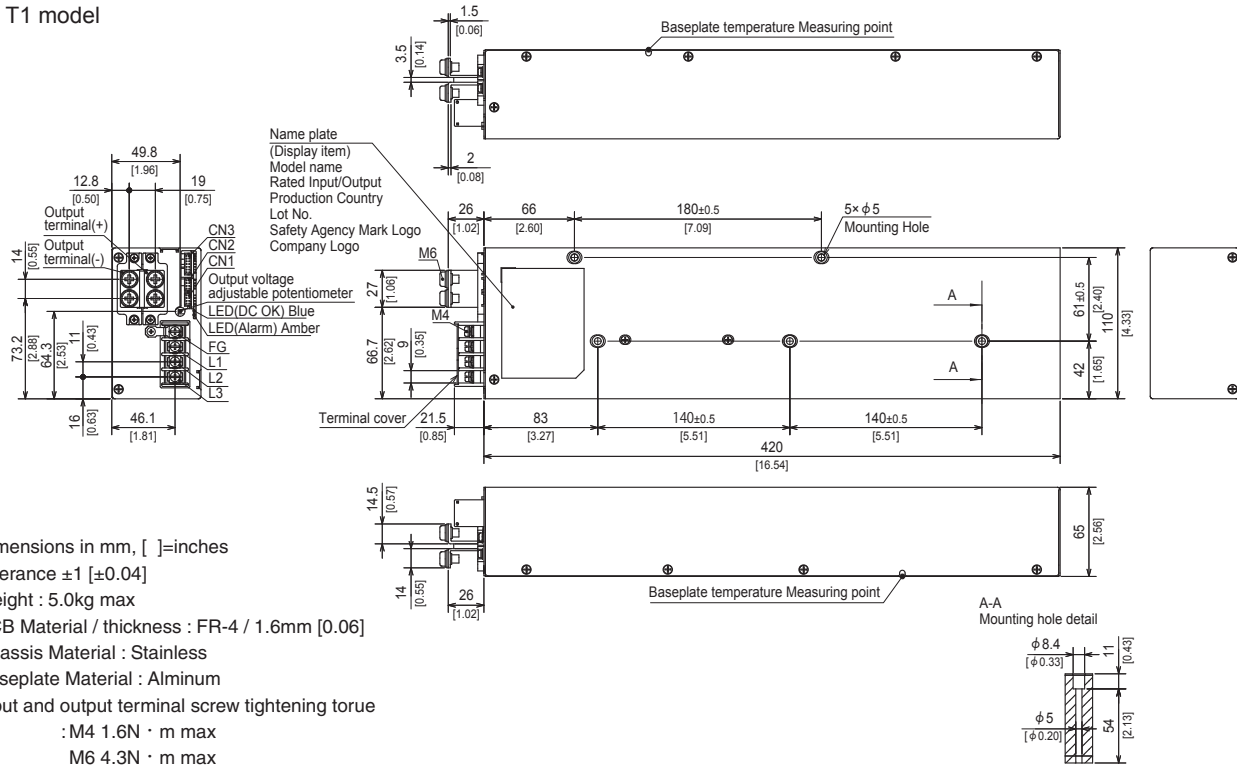

- * Dimensions in mm, []=inches
- * Tolerance ± 1 [± 0.04]
- * Weight : 5.0kg max
- * PCB Material / thickness : FR-4 / 1.6mm [0.06]
- * Chassis Material : Stainless
- * Baseplate Material : Alminum
- * Input and output terminal screw tightening torue
: M4 1.6N · m max
M6 4.3N · m max
- * Please connect safty ground to FG terminal on the unit.

Terminal Blocks

● HCA3500TF

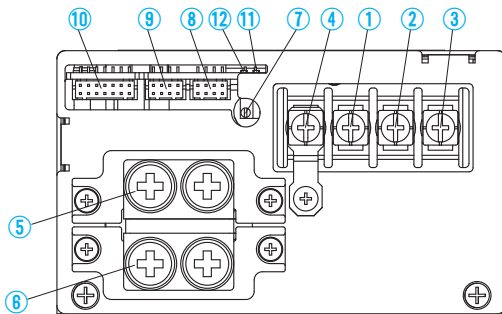

- ① AC (L1)
 - ② AC (L2)
 - ③ AC (L3)
 - ④ Frame ground (M4)
 - ⑤ + Output (M6)
 - ⑥ - Output (M6)
 - ⑦ Output voltage adjustable potentiometer
 - ⑧ CN1
 - ⑨ CN2
 - ⑩ CN3
 - ⑪ LED for output voltage confirmation (DC_OK) Color : Bule
 - ⑫ LED for fault condition detection (ALARM) Color : Orange
- Input Terminals 180–528VAC 3 φ 45–66Hz (M4)

Terminal Blocks

Pin Configuration and Functions

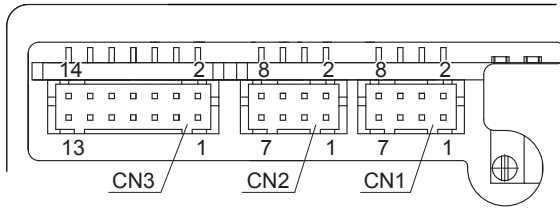

Pin Configuration and Functions of CN1, CN2

Pin No.	Function	Ground level
1	+S : +Remote sensing	COM
2,3	N.C. : No connection	-
4	-S : -Remote sensing	COM
5	CB : Current Balance	COM
6	N.C. : No connection	-
7	VTRM : Adjustment of output voltage	COM
8	COM : Common ground (for signal)	COM

* Each terminal of CN1 and CN2 are connected inside the power supply

Pin Configuration and Functions of CN3

Pin No.	Function	Ground level
1	AUXG : Auxiliary output ground	AUXG
2	SLV_ENG : Enable Slave mode ground	SLV_ENG
3	AUX : Auxiliary output	AUXG
4,5,6,8	N.C. : No connection	-
7	SLV_EN : Enable Slave mode	SLV_ENG
9	RC : Remote ON/OFF	RCG
10	RCG : Remote ON/OFF ground	RCG
11	WRN : Warning signal	WRNG
12	WRNG : Warning signal ground	WRNG
13	PG : Alarm signal	PGG
14	PGG : Alarm signal ground	PGG

Mating connector and terminal

Connector	Housing	Terminal	Mfr.
CN1	S8B-PHDSS	PHDR-8VS	Reel : SPHD-002T-P0.5
CN2	S8B-PHDSS	PHDR-8VS	Loose : BPHD-001T-P0.5 *
CN3	S14B-PHDSS	PHDR-14VS	BPHD-002T-P0.5 *

* The manufacturer prepares only the ratchet hand.

Assembling and Installation Method

- Use with the conduction cooling (e.g. heat dissipation from the aluminum base plate to the attached water-cooled plate).
- Recommended screw is M4. Select a screw length that allows the effective thread to be fastened to the water-cooled plate at least 4 mm.
- The recommended torque for the mounting screws is 0.94–1.25Nm (when the male screw is iron and the water-cooled plate is aluminum or copper).
- The aluminum base plate should be cooled uniformly.
- Use TIM (Thermal interface material) between the aluminum base plate and the water-cooled plate. It is recommended to use TIM with a thermal conductivity of 1 W/mK or more.
- The unit can be mounted in any direction. When two or more power supplies are used side by side, position them with proper intervals to allow enough air ventilation. Aluminum base plate temperature of each power supply should not exceed the temperature range shown in “derating”.

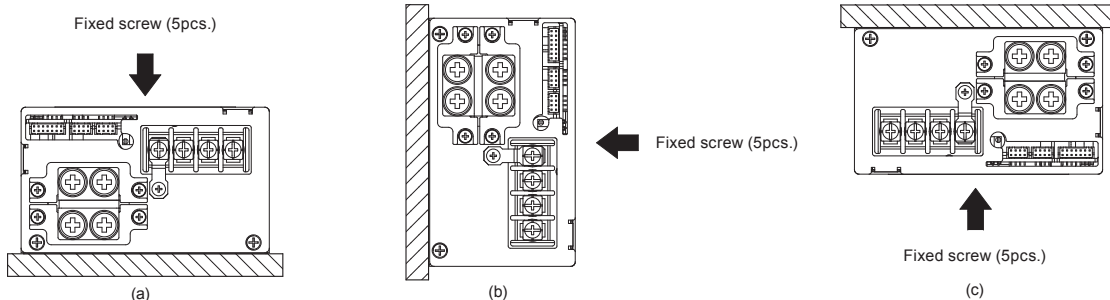

Derating

● Derating curve depends on Input voltage

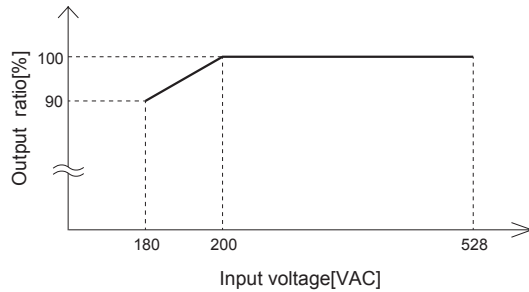

● Derating curve depends on Output voltage

- The unit should be used by the conduction cooling such as the water-cooled plate.
- The temperature of both points A and B has to be within the derating curve.
- Ambient temperature must keep between -10°C and 70°C.

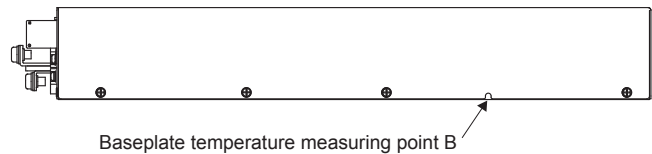
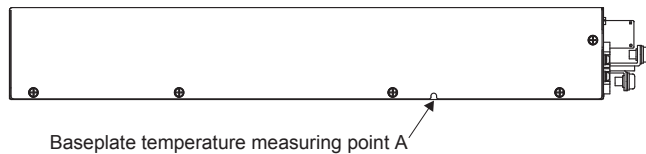
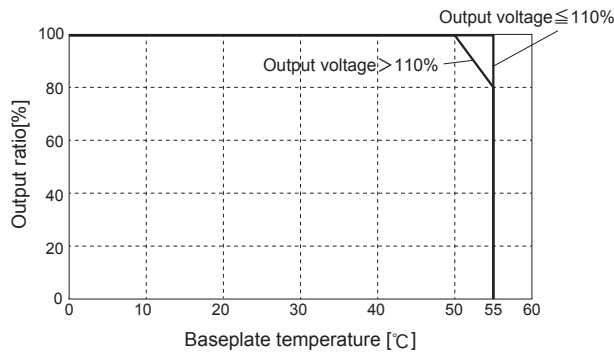

Instruction Manual

- ◆ It is necessary to read the "Instruction Manual" and "Before using our product" before you use our product.

Instruction Manual <https://www.cosel.co.jp/redirect/catalog/en/HCA/>
 Before using our product <https://en.cosel.co.jp/technical/caution/index.html>

HCA



NOTICE



Basic Characteristics Data

Model	Circuit method	Switching frequency [kHz]	Input current [A] *	Inrush current protection	PCB/Pattern			Series/Parallel operation availability	
					Material	Single sided	Double sided	Series operation	Parallel operation
HCA3500TF	Active filter	130	11.5	IGBT	FR-4		Yes	Yes	Yes
	Phase-shift Full-bridge converter	(Primary) 95 (Secondary) 190							

* The value of input current is at 200VAC input and rated load.