

COOLAUTOMATION
THE INTERNET OF CLIMATE

Quick Installation Guide

CoolPlug / CooLinkHub

HVAC Bridge

Contents

CoolPlugs and CoolLinkHub..... 5

System Overview

Wired connection - PBUS (Plug Bus) Topology

Wireless Connection Topology

CoolPlug Models

What's in the box

Connecting CoolPlug DK (Daikin)..... 10

DK (Daikin) - P1 P2

DK (Daikin) - S21 (Old Rev.)

DK (Daikin) - S21 (New Rev.)

DK (Daikin) - S403

DK (Daikin) - Siesta Series

Connecting CoolPlug PN/SA/TO 15

Panasonic|Sanyo|Toshiba

Panasonic CAPRA

Connecting CoolPlug FJ (Fujitsu/General) 17

FJ (Fujitsu/General) - Option 1 - 3 wires

FJ (Fujitsu/General) - Option 2 - 3 wires

FJ (Fujitsu/General) - Option 3 - 2 wires

FJ (Fujitsu/General) - Option 4 - 3 wires to adapter

Connecting CoolPlug ME (Mitsubishi Electric). . 21

ME (Mitsubishi Electric) Option 1 – [1] [2]

ME (Mitsubishi Electric) Option 2 – CN-105

Connecting CoolPlug MH (Mitsubishi Heavy)....23

Connecting CoolPlug HT (Hitachi).....24

Connecting CoolPlug LG (LG)..... 25

Connecting CoolPlug MD (Midea) 26

CoolPlug GRTS (Gree).....28

Gree - Option 1 - When WRC connect to indoor units board

Gree - Option 2 - When WRC connect to indoor units cable

Gree - Option 3 - 2 wires

Connecting CoolPlug Gree GMV5 (GR).....31

Connecting CoolPlug Samsung (SM)32

Samsung - Option 1 - 2 wires

Samsung - Option 2 - 4 wires

Connecting Home Automation,

BMS & ControlApp34

Control App35

CoolPlug Operation.....36

Wireless CoolPlug & CoolLinkHub - Installation

Guidelines 38

How to pair and connect CoolPlug to CoolLinkHub

Rebuilding the wireless mesh network

Mounting the CoolPlug41

Safety Guidelines, Warnings and Cautions

Read and understand the following guidelines to ensure safe installation.



Failure to follow these **WARNINGS** may result in injury or death

This equipment is to be installed by an accredited electrician or equivalent technical person, as per these installation instructions.

Read the installation instructions before connecting the system to the power source.

All electrical work must be performed by a licensed technician, according to local regulations.

Ultimate disposal of this product should be handled according to all national laws and regulations.

Installation of the equipment must comply with local and national electrical legislation for the installation of electric equipment.

Do not install the devices outdoors or exposed to direct solar radiation, water, high relative humidity, or dust.

Install the equipment only in a restricted access location.

When wall mounting, be sure to fix firmly on a stable surface and in accordance with the instructions below.

When DIN rail mounting, fix the devices properly to the DIN rail following the instructions below.

When mounting on DIN rail inside a metallic cabinet be sure to properly connect to the ground.

Unplug from power when connecting the wires.

Pay attention to the polarity of power and communication cables during connection.

Disconnect power of any bus or communication cable before connecting the system.

Cautions

Failure to follow these CAUTIONs may result in serious injury.

Do not allow children to play with the CoolPlug or CoolLinkHub.

Do not disassemble, modify, or repair the CoolPlug or CoolLinkHub. Unauthorized modifications or repairs may result in electric shock or fire. For support, contact CoolAutomation.

Do not expose the CoolPlug or CoolLinkHub, to moisture.

Water can damage the CoolPlug or CoolLinkHub resulting in an electrical components failure, electric shock or fire.

Do not use flammable materials (e.g. hairspray or insecticide) near the CoolPlug or CoolLinkHub. Do not clean with organic solvents such as paint thinner.

Use only a dry cloth to wipe if necessary. The maximum voltage that can be directly applied to the CoolLinkHub is 24V DC.

Do not plug into AC110V or AC220V.

DO NOT INSTALL the COOLINKHUB or COOLPLUG IN THE FOLLOWING LOCATIONS:

- a)** Where mineral oil mist or oil spray or vapor is produced, such as in a kitchen. Plastic parts may deteriorate and fall off.
- b)** Where corrosive gas, such as sulfurous acid gas, is produced.
- c)** Near machinery emitting electromagnetic waves.
Electromagnetic waves may disturb or damage the operation of the CoolLinkHub.
- d)** Where flammable gas may leak, where there is carbon fiber or ignitable dust suspensions in the air, or where volatile flammables such as thinner or gasoline are handled. Operating the CoolLinkHub or CoolPlug in such conditions may cause a fire.
- e)** In high temperature areas or near any flame.
- f)** In moist areas, or where there is exposure to water.

CoolPlugs and CoolLinkHub

System Overview

The CoolPlugs & CoolLinkHub solution allows seamless integration of Split, Multi-Split and Mini-Split HVAC units with Home Automation, BMS and Smart IOT products and services; or full control and monitoring, using a standalone CoolAutomation cloud-based App (ControlApp).

Once connected, it allows full control of the indoor unit including the following functions: on/off, operation mode (cool/heat/fan/dry/auto), set points, adjust fan speed and activate swivel.

The solution allows bidirectional communication with the indoor unit for receiving error codes from the unit as well as feedback about actual status of the HVAC unit. CoolPlug connects directly to the HVAC indoor unit on one end, and to the CoolLinkHub on the other.

CoolLinkHub - aggregates multiple CoolPlug devices and provides wide interface options for controlling and monitoring each of the CoolPlugs, either over the wired network (PBUS) or a proprietary wireless mesh network.

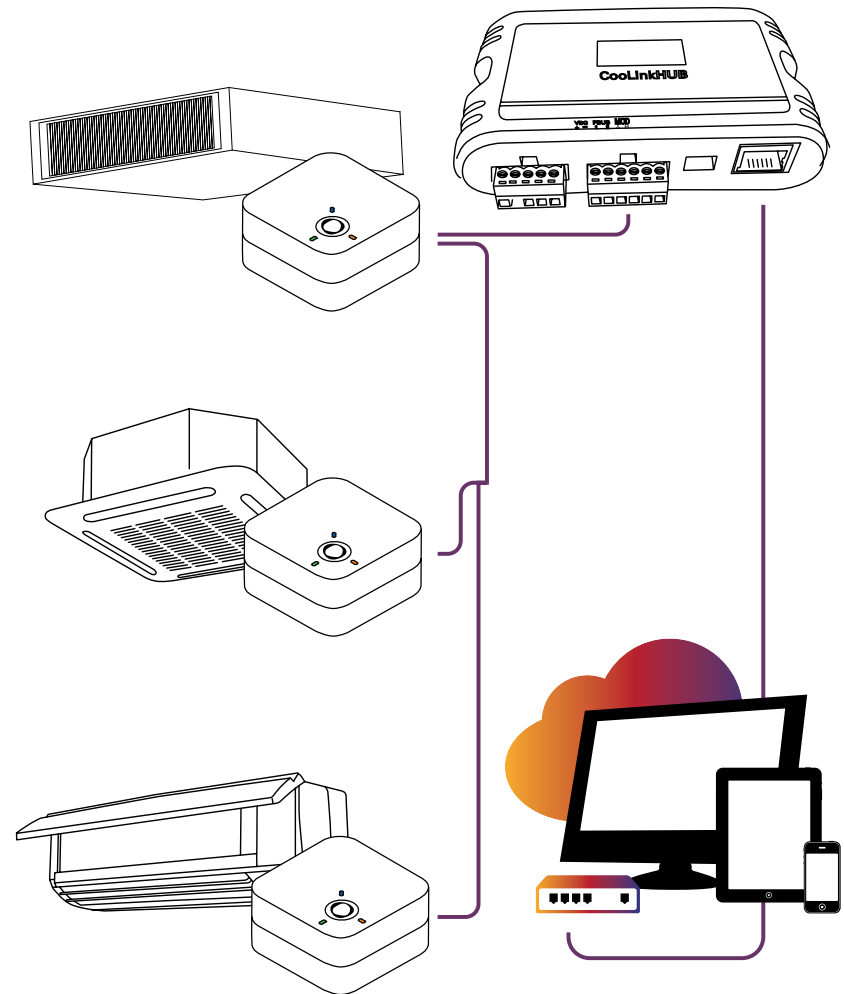

Wired connection - PBUS (PlugBus) Topology

The PBUS is CoolAutomation's proprietary Bus, running on a shielded twisted pair cable (20-24AWG).

The PBUS utilizes daisy chain network topology. No loops are allowed.

Up to 10 CoolPlugs can be connected to a single CoolLinkHub.

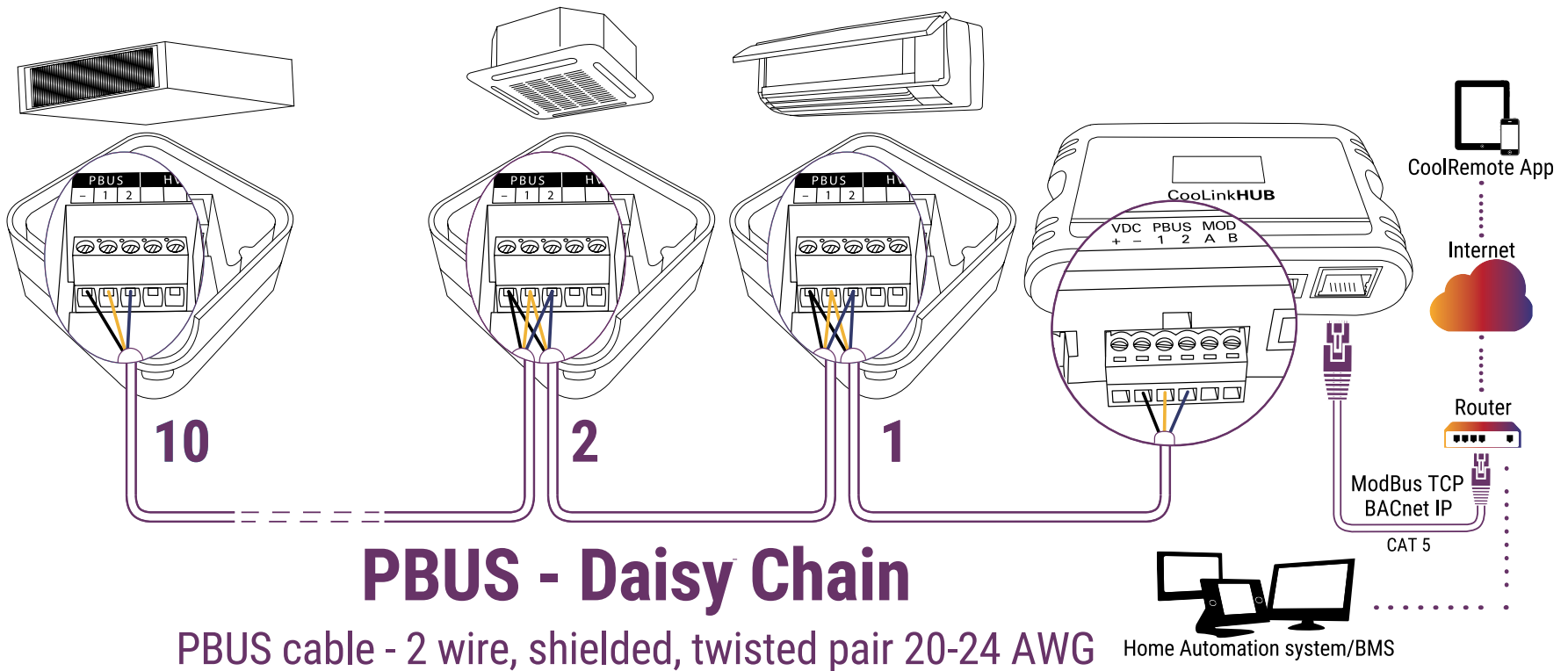

Wireless connection - PBUS (PlugBus) Topology

WRLS Cool Plugs and WRLS CoolLinkHub communicate with each other using CoolAutomation's 2.4 GHz proprietary and secured **mesh** network.

Each WRLS CoolLinkHub creates a network and automatically connects to all paired devices within this network (WRLS CoolPlugs). Pairing of the WRLS CoolPlugs with the specific WRLS CoolLinkHub can be factory pre-set (prior to shipment) or configured locally (please refer to pairing instructions at [page 35](#)).

Up to 10 CoolPlug devices can be connected to a single CoolLinkHub.

The recommended distance between each of the two devices (CoolPlug/ CoolLinkHub) is up to 20m (50 ft) line of sight. Please note, that concrete walls, ceilings and other types of obstacles or noise caused from electro-magnetic fields (generated by power cables or other sources), can significantly impact signal strength and will result in reduced distance.

The network topology is a mesh type network, meaning that each device acts as a receiver and a transmitter, and repeats the signal. For planning purposes, make sure you have connectivity between each of the two devices (CoolPlug with its neighbor CoolPlug, or CoolPlug with the CoolLinHub).

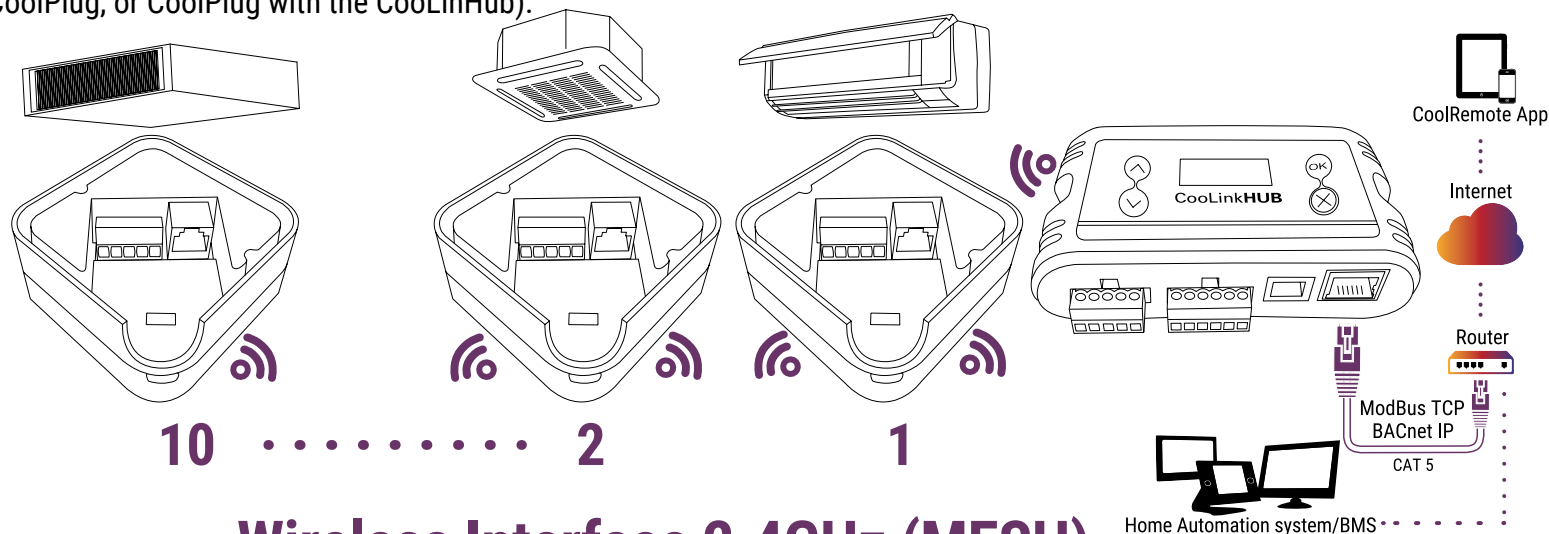

Wireless Interface 2.4GHz (MESH)

CoolPlug Models

CoolPlug models are HVAC manufacturer specific. Each CoolPlug has a small round sticker with letters on its back (DK, DKS, etc.) indicating the HVAC manufacturer that the CoolPlug is compatible with.

CoolPlug Model	HVAC Vendor	Cable included	Terminals/comments
HVAC DK	Daikin	S21, S21 narrow	S21, P1 P2, S403
HVAC DKS	Daikin Siesta Series	Siesta	
HVAC SA TO PN	Sanyo Toshiba Panasonic		A B, R1 R2
HVAC PN CAPRA	Panasonic Capra	CAPRA	CN-CNT
HVAC FJ	Fujitsu/General	FJ003	2 wires, 3 wires
HVAC ME	Mitsubishi Electric	CN105	CN105, 1 2
HVAC MH	Mitsubishi Heavy		2 wires only
HVAC HT	Hitachi		VRF only
HVAC MD	Midea		X Y E
HVAC LG	LG	LG split cable	
HVAC GR	Gree		GMV5 VRF only
HVAC GRTS	Gree	4 wire x 4	4 wires, 2 wires
HVAC SM	Samsung		4 wires, 2 wires

What is in the box?

CoolPlug

- CoolPlug device
- Flat plastic back plate
- DIN rail plastic back plate
- 2 sticky bands
- 2 magnets

CooLinkHub

- CooLinkHub device
- USB cable
- RS-232 cable (optional)
- RJ45 Ethernet cable

* Cables - only for specific brands. See table on P.8 above.

** For Midea wireless model - Power Adapter may be included if ordered seperately.

Connecting CoolPlug DK (Daikin)

DK (Daikin) – When connecting to P1 P2

- 1** Connecting the CoolPlug to the Daikin unit
Connect the CoolPlug's [P1], [P2] terminals to the [P1], [P2] terminals on the indoor unit. Use the HVAC manufacturer's Installation Manual for instructions on the location of P1 P2 terminals on the Daikin unit.
- 2** Connecting the CoolPlug to the CoolLinkHub
Wireless Mode: Check the devices were paired successfully. See how to pair on [page 35](#).
Wired Mode: Connect the signal wires of the PBUS cable coming from the [VDC-], [1] and [2] terminals on the CoolLinkHub to the corresponding [-], [1] and [2] terminals on the CoolPlug, respectively.
Please refer to the PBUS connection diagram on [page 6](#).
- 3** Optional: Connect the Wired Remote Controller (WRC) in parallel with CoolPlug.

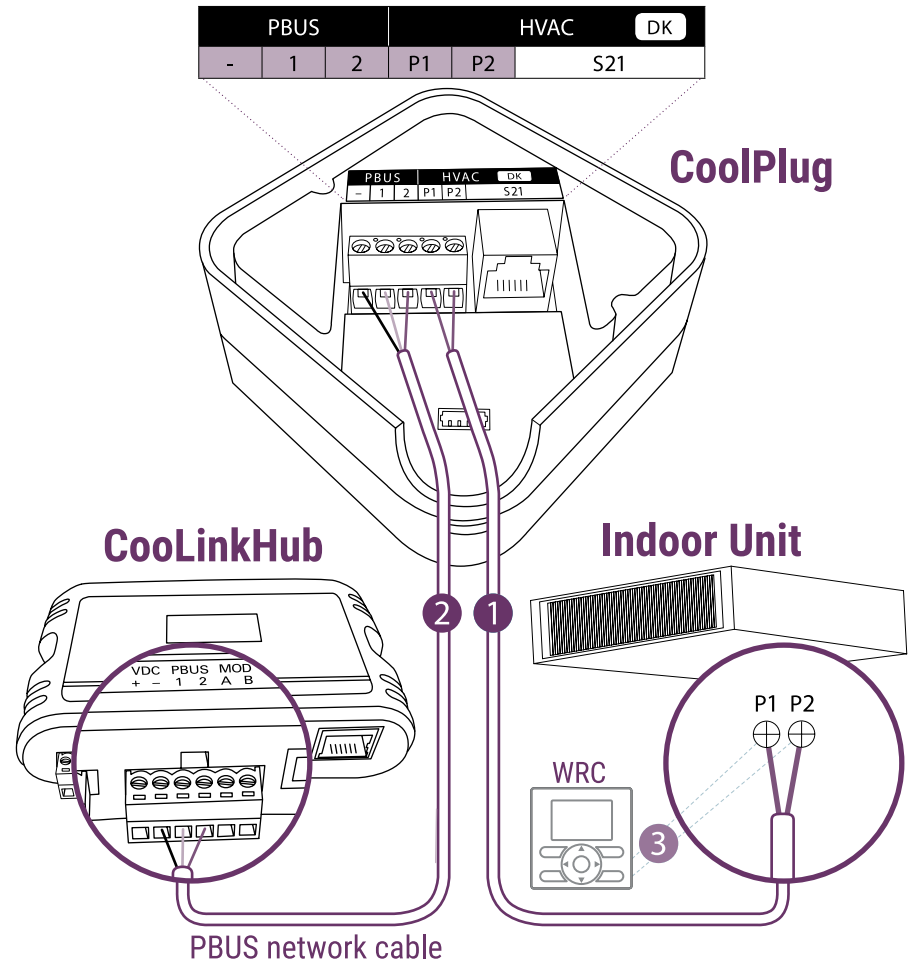

* The connection is nonpolar.

** Master/Slave configuration will be done by the CoolPlug automatically.

Connecting CoolPlug DK (Daikin)

DK (Daikin) – When connecting to s21 (Old Rev.)

- 1** Connecting the CoolPlug to the Daikin unit
Connect the S21 cable supplied with the CoolPlug, between the CoolPlug RJ-11 connector and the S21 port on the indoor unit's PCB. Use Daikin's installation manual for the location of the S21 socket on the Daikin indoor PCB.
- 2** Connecting the CoolPlug to the CoolLinkHub
Wireless Mode: Check the devices were paired successfully. See how to pair on [page 35](#).
Wired Mode: Connect the signal wires of the PBUS cable between CoolPlug terminals [-], [1] and [2], and CoolLinkHub terminals [VDC-], [1] and [2], respectively. Please refer to the PBUS connection diagram on [page 6](#).
- 3** **Optional:** For connecting the Daikin Wired Remote controller (WRC) in parallel with CoolPlug, the S21 Splitter **4** is required. (This part can be purchased from CoolAutomation).

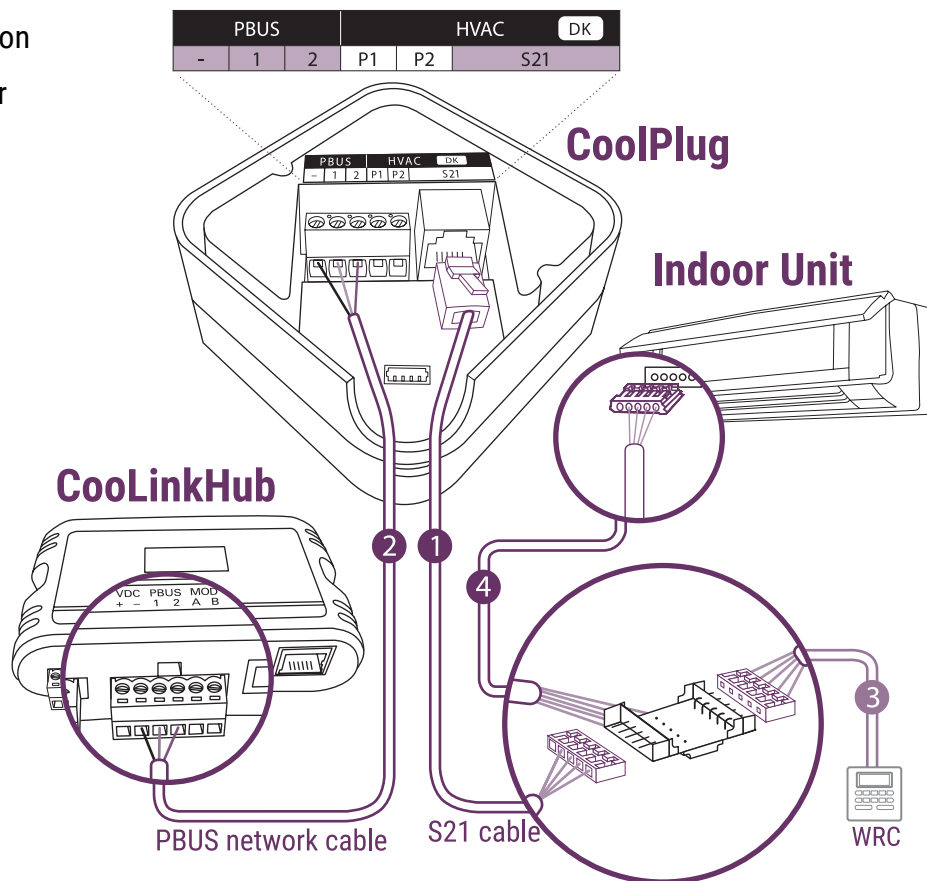

* Master/Slave configuration will be done by the CoolPlug automatically.

** A different Daikin version might have a smaller 5 pin connector, in that case use **EKRS 21 adapter**.

Connecting CoolPlug DK (Daikin)

DK (Daikin) – When connecting to S21 (New Rev. started from Q4 2021)

1 Connecting the CoolPlug to the Daikin unit.

Connect the S21 cable supplied with the CoolPlug, between the CoolPlug **Indoor** connector (bottom S21 socket on CoolPlug) and the S21 port on the indoor unit's PCB. Use Daikin's installation manual for the location of the S21 socket on the Daikin indoor PCB.

2 Connecting the CoolPlug to the CoolLinkHub.

Wireless Mode: Check the devices were paired successfully. See how to pair on [page 35](#).

Wired Mode: Connect the signal wires of the PBUS cable between CoolPlug terminals [-], [1] and [2], and CoolLinkHub terminals [VDC-], [1] and [2], respectively. Please refer to the PBUS connection diagram on [page 6](#).

3 Optional: For connecting the Daikin Wired Remote Controller connect the cable from controller to CoolPlug **WRC** (Wired Remote Controller) **socket** (top S21 socket).

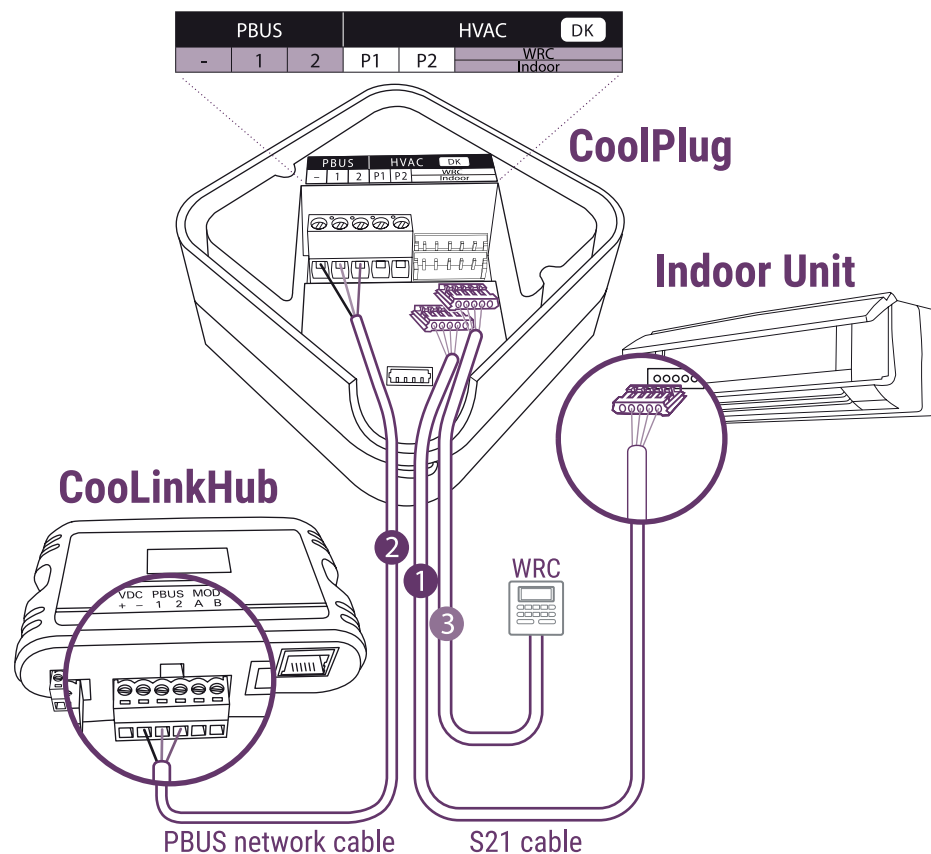

* On Some Daikin indoor models, you will need the cable with the smaller 5 pin S21 connector. This cable is also provided with the CoolPlug as an option were needed.

Connecting CoolPlug DK (Daikin)

DK (Daikin) – When connecting to S403 using KRP980B1

1 Connecting the CoolPlug to the Daikin unit.

Connect the S21 cable supplied with the CoolPlug, between the CoolPlug **Indoor** connector (bottom S21 socket on CoolPlug) and the S21 port on **KRP980B1 adapter's** PCB.

Use Daikin's installation manual to install **KRP980B1 adapter** into the Daikin indoor unit. Connect adapter to the S403 socket inside.

2 Connecting the CoolPlug to the CoolLinkHub.

Wireless Mode: Check the devices were paired successfully. See how to pair on [page 35](#).

Wired Mode: Connect the signal wires of the PBUS cable between CoolPlug terminals [-], [1] and [2], and CoolLinkHub terminals [VDC-], [1] and [2], respectively. Please refer to the PBUS connection diagram on [page 6](#).

3 Optional: To connect the Daikin Wired Remote Controller connect the cable from controller to CoolPlug **WRC** (Wired Remote Controller) **socket** (top S21 socket).

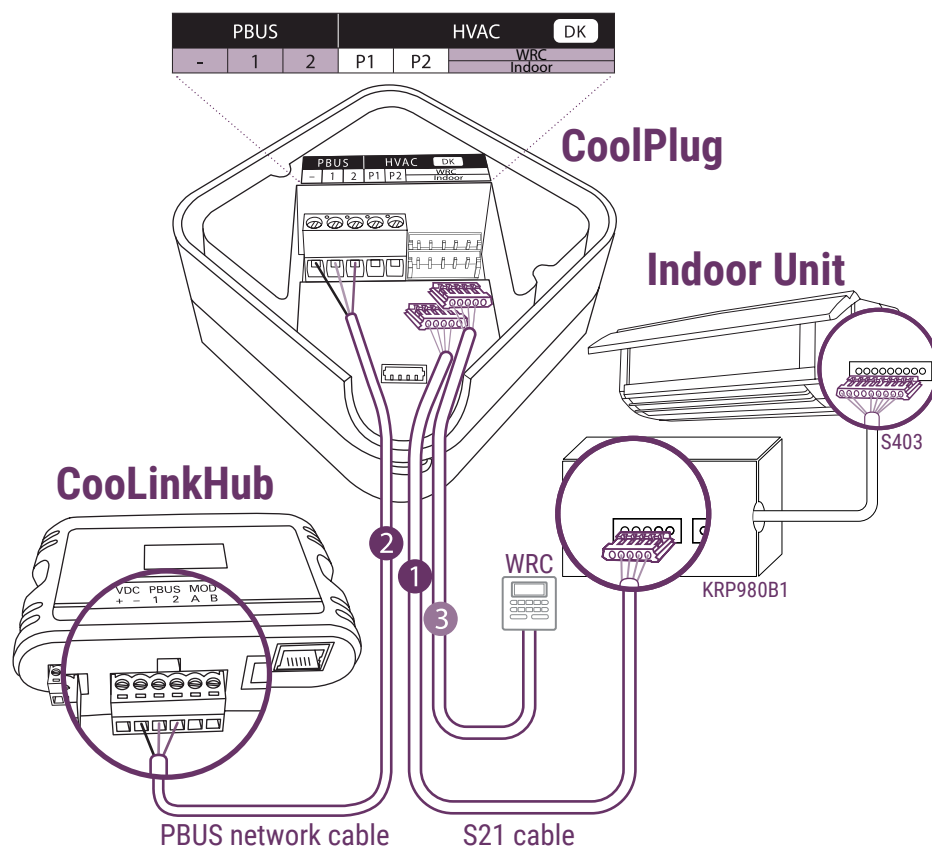

* KRP980B1 adapter should be purchased separately from your Daikin rep.

Connecting CoolPlug DK (Daikin)

DKS (Daikin) – Siesta Series

- 1** Connecting the CoolPlug to the Daikin Indoor Unit
Connect the cable (supplied with the CoolPlug) to the port labeled “Indoor” on the CoolPlug and the corresponding connector on the indoor unit.
Use Daikin's Installation Manual for instructions on where to connect to on the Daikin indoor PCB.
- 2** Connecting the CoolPlug to the CoolLinkHub
Wireless Mode: Check the devices were paired successfully. See how to pair on [page 35](#).
Wired Mode: Connect the signal wires of the PBUS cable, using [VDC-], [1] and [2] terminals on the CoolLinkHub, to the corresponding [-], [1] and [2] terminals on the CoolPlug.
Please refer to the PBUS connection diagram on [page 6](#).
- 3** **Optional:** Connect the wired remote to the WRC socket on the CoolPlug. The cable is supplied with the WRC.

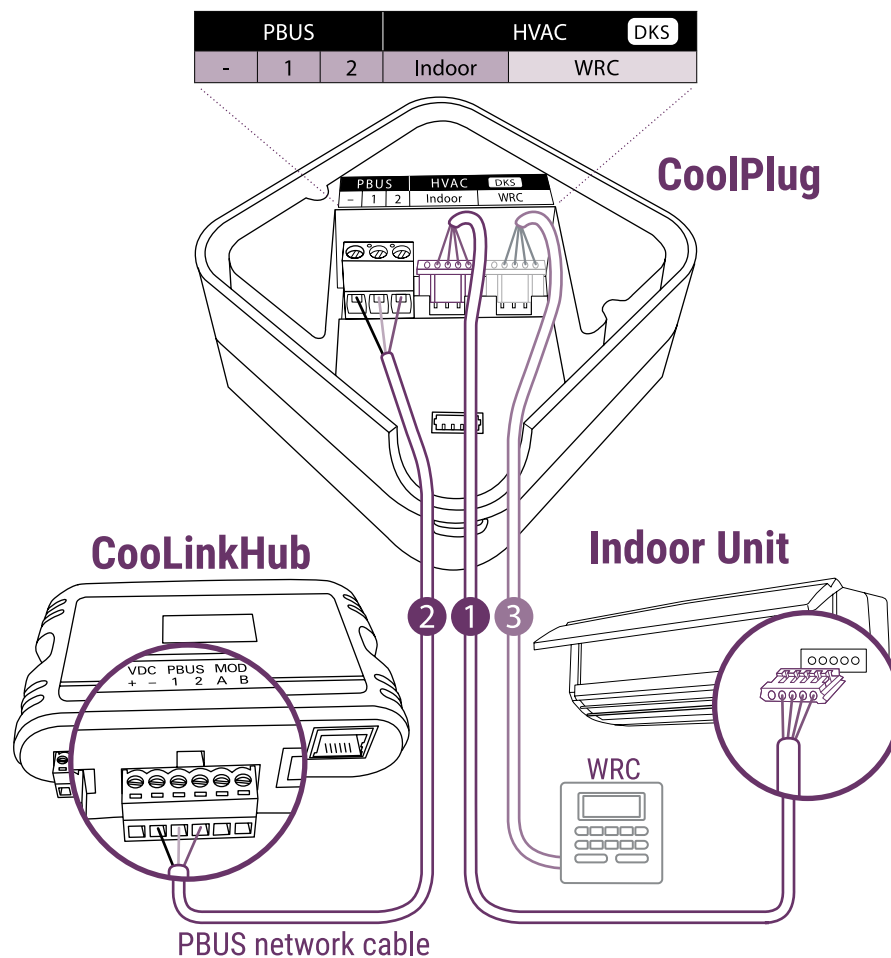

Connecting CoolPlug PN|SA|TO

CoolPlug Panasonic/Sanyo/Toshiba

- 1** Connecting the CoolPlug to the PN/SA/TO Indoor Unit
Connect the CoolPlug's [A], [B] terminals to [A], [B] terminals to the indoor unit (Sanyo/Toshiba) or to [R1], [R2] (Panasonic). Use HVAC manufacturer's Installation Manual for instructions on finding those terminals on the indoor unit PCB.
- 2** Connecting the CoolPlug to the CoolLinkHub
Wireless Mode: Check the devices were paired successfully. See how to pair on [page 35](#).
Wired Mode: Connect the signal wires of the PBUS cable coming from the [VDC-], [1] and [2] terminals on the CoolLinkHub to the corresponding [-], [1] and [2] terminals on the CoolPlug.
Please refer to the PBUS connection diagram on [page 6](#).
- 3** **Optional:** Connect the wired remote to the WRC socket on the CoolPlug. The cable is supplied with the WRC.

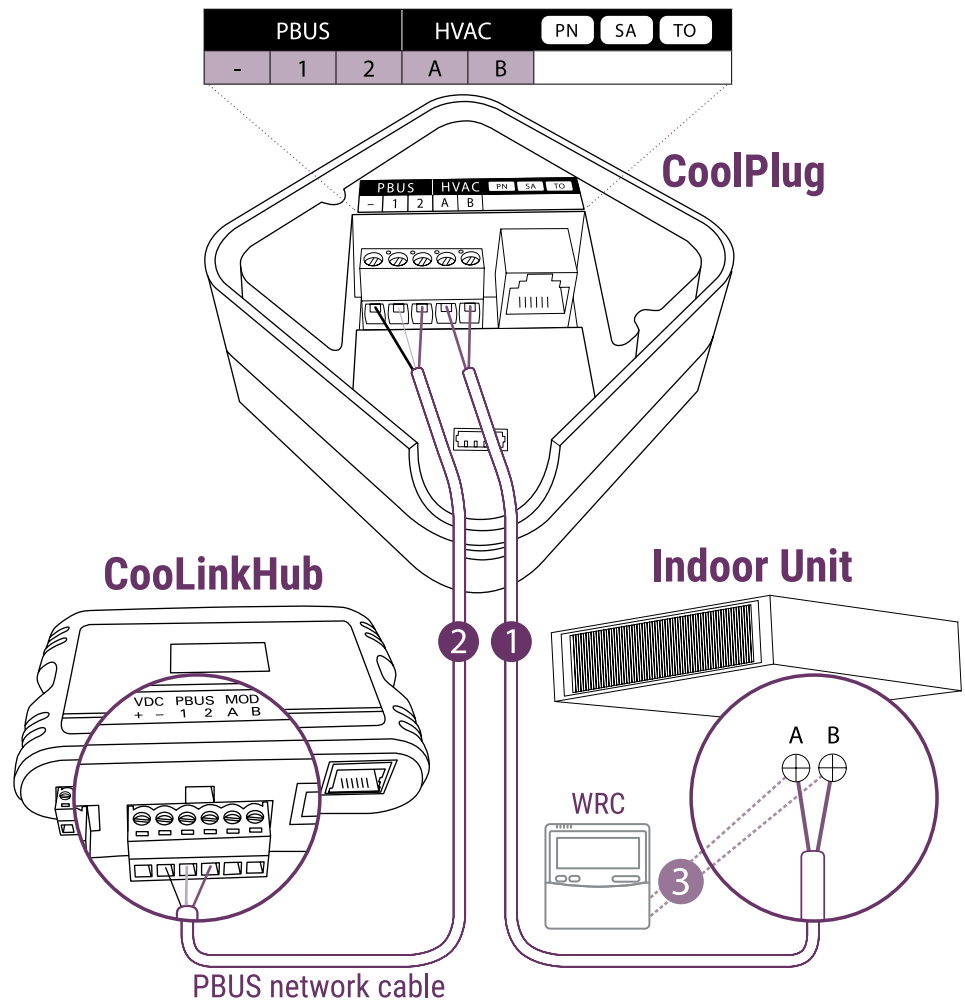

* The connection is nonpolar.

** Master/Slave configuration will be done by the CoolPlug automatically.

Connecting CoolPlug PN|SA|TO

CoolPlug Panasonic CAPRA

- 1 Connecting the CoolPlug to the Panasonic units with CAPRA connectors

Connect the CAPRA cable (supplied with the CoolPlug) between the CoolPlug RJ-11 connector (CN - CNT) and the CN - CNT port on the indoor unit's PCB. Use HVAC manufacturer's installation manual for location of CN - CNT connector on the indoor unit's PCB.

- 2 Connecting the CoolPlug to the CoolLinkHub

Wireless Mode: Check the devices were paired successfully. See how to pair on [page 35](#).

Wired Mode: Connect the signal wires of the PBUS cable coming from the [VDC-], [1] and [2] terminals on the CoolLinkHub to the corresponding [-], [1] and [2] terminals on the CoolPlug.

Please refer to the PBUS connection diagram on [page 6](#).

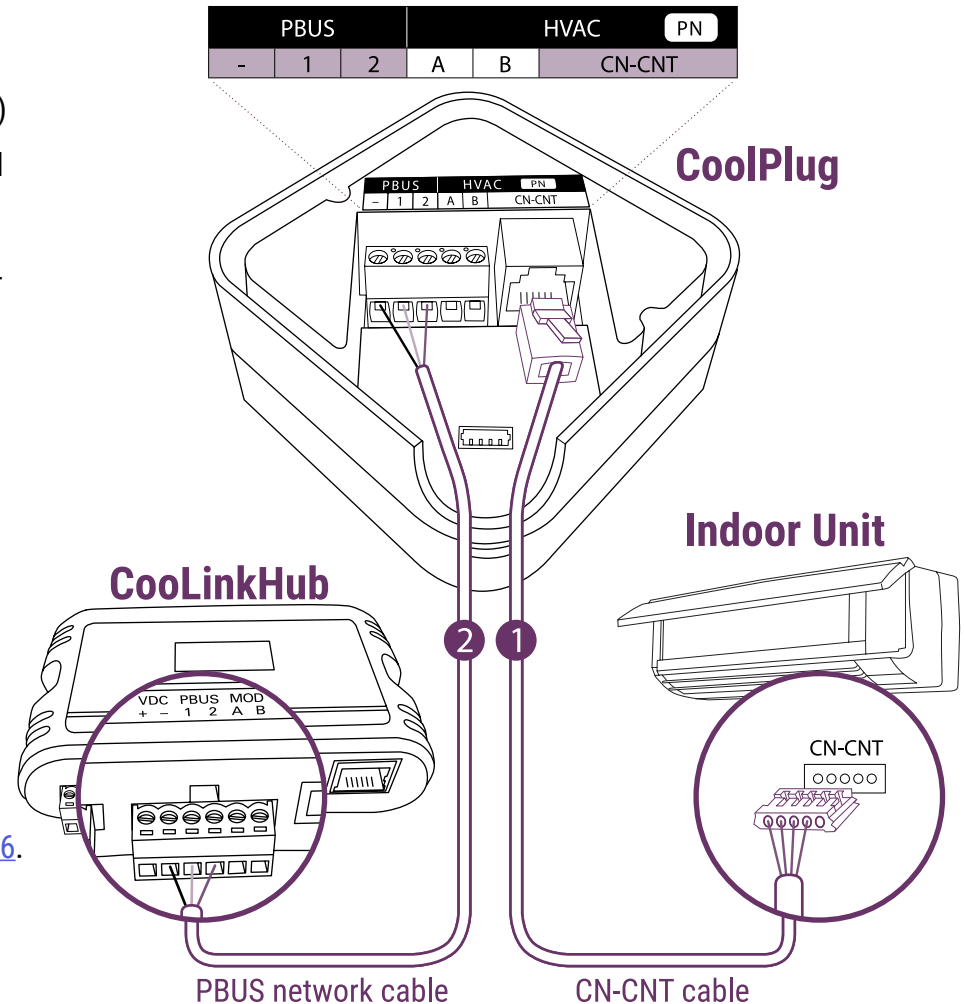

Connecting CoolPlug FJ

FJ (Fujitsu/General) - Option 1: 3 wires

1 Connecting the CoolPlug to the Fujitsu Indoor Unit

Connect the CoolPlug's [W1], [BIY], [RIY] terminals to corresponding terminals on the indoor unit, keeping the wiring consistent by colors.

2 Connecting the CoolPlug to the CoolLinkHub

Wireless Mode: Check the devices were paired successfully. See how to pair on [page 35](#).

Wired Mode: Connect the signal wires of the PBUS cable, using the [VDC-], [1] and [2] terminals on the CoolLinkHub, to the corresponding [-], [1] and [2] terminals on the CoolPlug.

Please refer to the PBUS connection diagram on [page 6](#).

3 Optional: Connect the Wired Remote Controller (WRC) in parallel with CoolPlug.

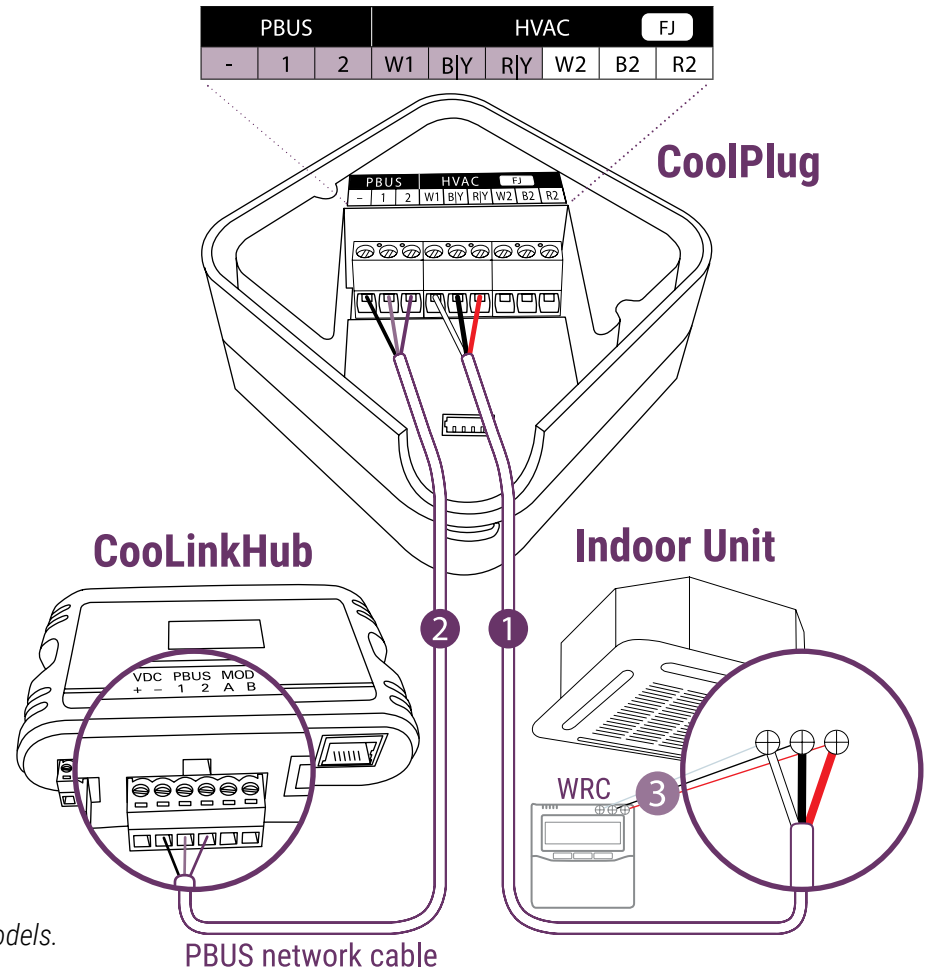

* For indoor units that work with **APG000** or compatible WRC models.

** Room temperature will not be shown if original WRC is not connected.

*** Reset power of the Fujitsu Indoor unit, once the CoolPlug is installed.

**** Master/Slave configuration will be done by the CoolPlug automatically.

Connecting CoolPlug FJ

FJ (Fujitsu/General) - Option 2: 3 wires

- 1** Connecting the CoolPlug to the Fujitsu Indoor Unit
Connect the CoolPlug's [W1], [BIY], [RIY] terminals to the corresponding terminals (for WRC) on the indoor unit. Use Fujitsu's Installation manual for instructions on how to locate those terminals for WRC.
- 2** Connecting the CoolPlug to the CoolLinkHub
Wireless Mode: Check the devices were paired successfully. See how to pair on [page 35](#).
Wired Mode: Connect the signal wires of the PBUS cable from the [VDC-], [1] and [2] terminals on the CoolLinkHub to the corresponding [-], [1] and [2] terminals on the CoolPlug.
Please refer to the PBUS connection diagram on [page 6](#).
- 3** **Optional:** Connect CoolPlug's [W2], [B2], [R2] terminals to the Fujitsu Wired Remote Controller (WRC).

* For indoor units that work with **EZ-099** or compatible type wired remote controllers.

** Reset power of AC indoor unit, once the CoolPlug is installed.

*** Room temperature will not be presented if original WRC is not connected.

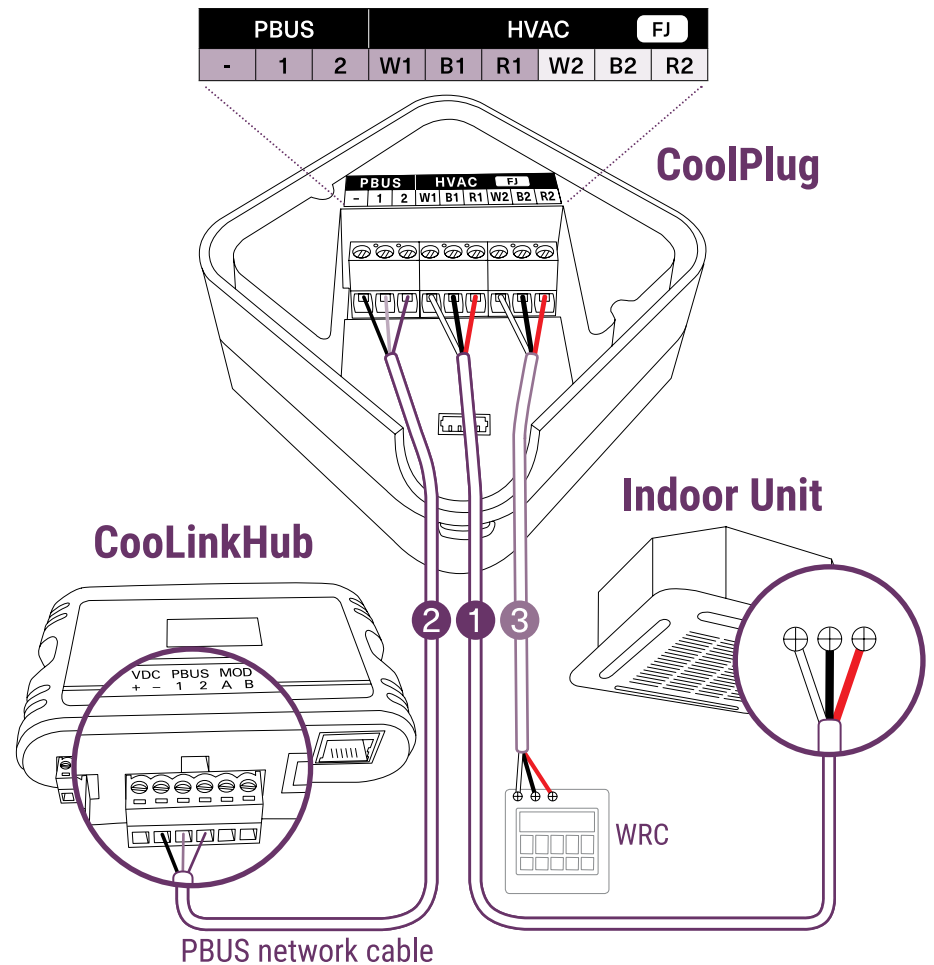

Connecting CoolPlug FJ

FJ (Fujitsu/General) - Option 3: 2 wires

- 1** Connecting the CoolPlug to the Fujitsu Indoor Unit
Connect the CoolPlug's [B1/Y], [R1/Y] terminals to the Y1 Y2 terminals on the indoor unit accordingly.
- 2** Connecting the CoolPlug to the CoolLinkHub
Wireless Mode: Check the devices were paired successfully. See how to pair on [page 35](#).
Wired Mode: Connect the signal wires of the PBUS cable, using the [VDC-], [1] and [2] terminals on the CoolLinkHub, to the corresponding [-], [1] and [2] terminals on the CoolPlug. Please refer to the PBUS connection diagram on [page 6](#).
- 3** **Optional:** Connect the Wired Remote Controller (WRC) in parallel with CoolPlug.

* Reset power of AC indoor unit, once the CoolPlug is installed.

** If indoor unit has V1, V2, V3 terminals, connect the CoolPlug and WRC to terminals V1, V2.

*** The connection is nonpolar.

**** Master/Slave configuration will be done by the CoolPlug automatically.

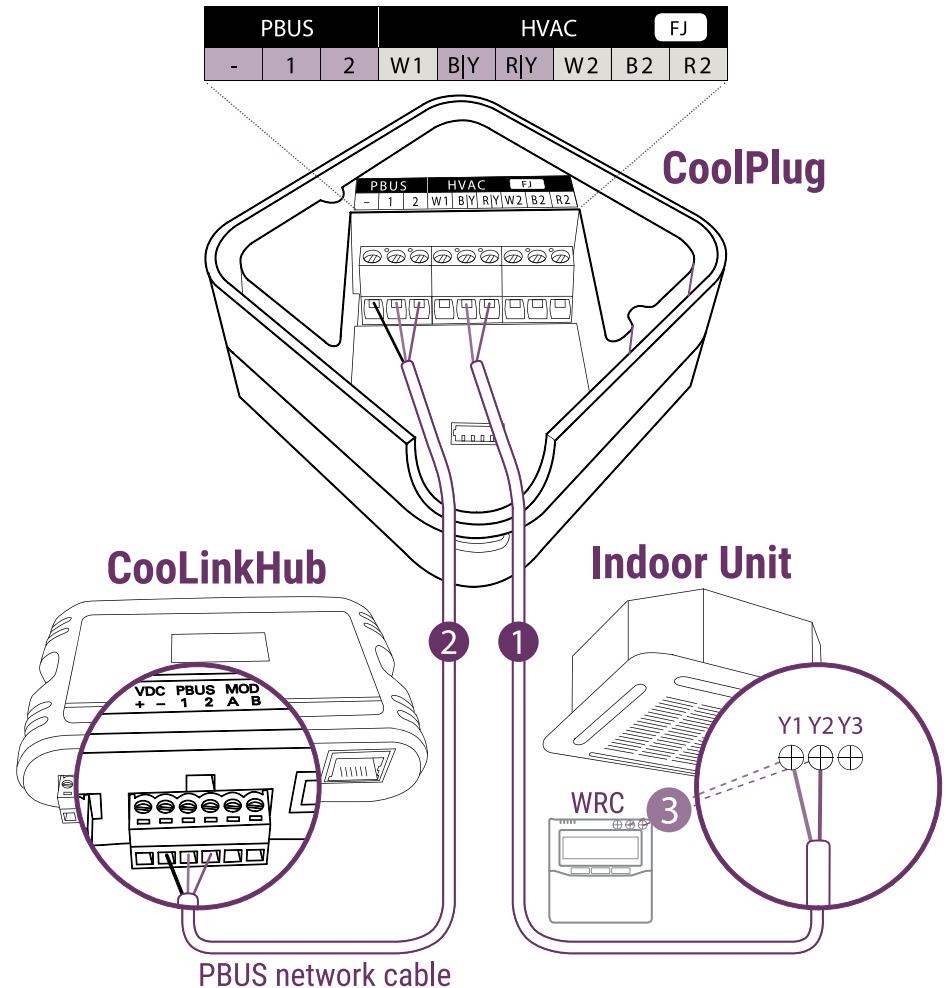

Connecting CoolPlug FJ

FJ (Fujitsu/General) - Option 4: 3 wires to adapter

1 Connecting the CoolPlug to the Fujitsu **UTY-XCBXZ1/UTY-XCBXZ2/UTY- TWBXF adapter**

Connect the FJ-003 cable supplied with the CoolPlug to [W1], [BY], [RY] ports on the the CoolPlug side, and the 5 pin cable connector to the UTY-XCBXZ1/UTY-XCBXZ2/ UTY- TWBXF adapter.

2 Connecting the CoolPlug to the CoolLinkHub

Wireless Mode: Check the devices were paired successfully. See how to pair on [page 35](#).

Wired Mode: Connect the signal wires of the PBUS cable, using the [VDC-], [1] and [2] terminals on the CoolLinkHub, to the corresponding [-], [1] and [2] terminals on the CoolPlug.

Please refer to the PBUS connection diagram on [page 6](#).

3 Optional: Connect the Wired Remote Controller (WRC) in parallel with CoolPlug.

** To get the room temperature use external Thermo sensor. The sensor is purchased separately from CoolAutomation.*

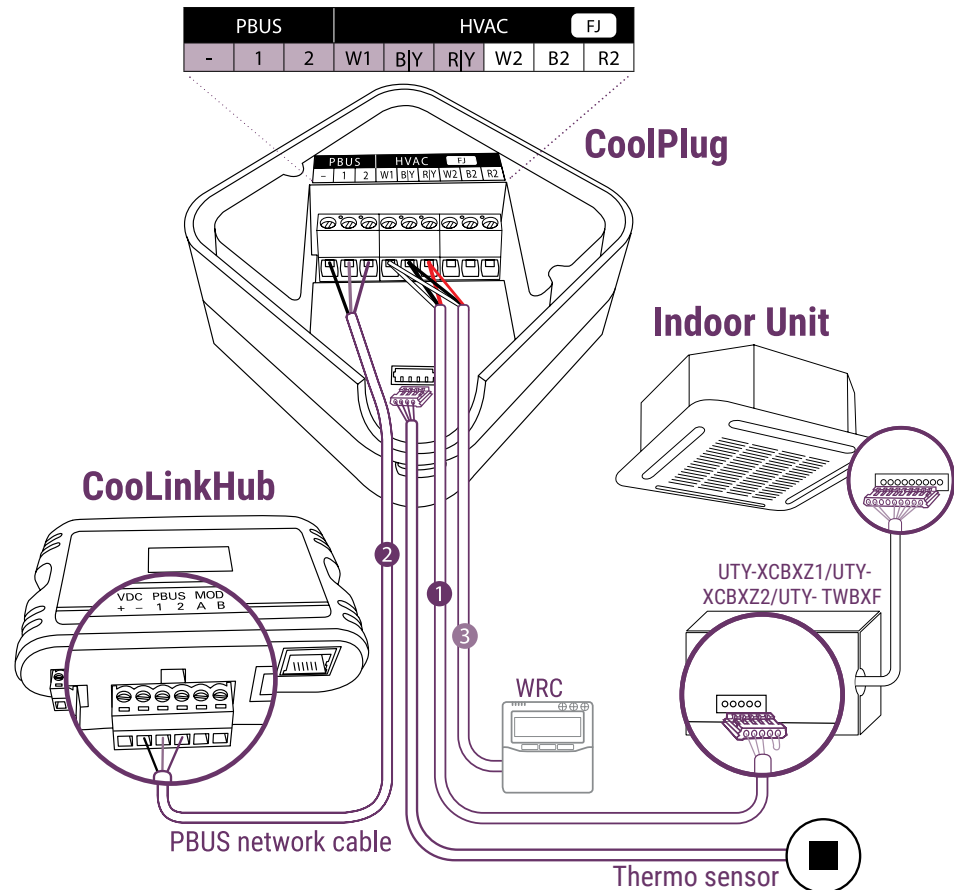

Connecting CoolPlug ME (Mitsubishi Electric)

ME (Mitsubishi Electric) – When connecting to [1] [2]

1 Connecting the CoolPlug to the Mitsubishi Indoor Unit

Connect terminals HVAC [1] [2] to [1], [2] terminals on indoor unit accordingly. Use HVAC manufacturer's installation manual for location of [1] [2] terminals on the Mitsubishi indoor unit.

2 Connecting the CoolPlug to the CoolLinkHub

Wireless Mode: Check the devices were paired successfully. See how to pair on [page 35](#).

Wired Mode: Connect the signal wires of the PBUS cable, using [VDC-], [1] and [2] terminals on the CoolLinkHub to the corresponding [-], [1] and [2] terminals on the CoolPlug.

Please refer to the PBUS connection diagram on [page 6](#).

3 Optional: Connect the Wired Remote Controller (WRC) in parallel with the CoolPlug.

* The connection is nonpolar.

** Master/Slave configuration will be done by the CoolPlug automatically.

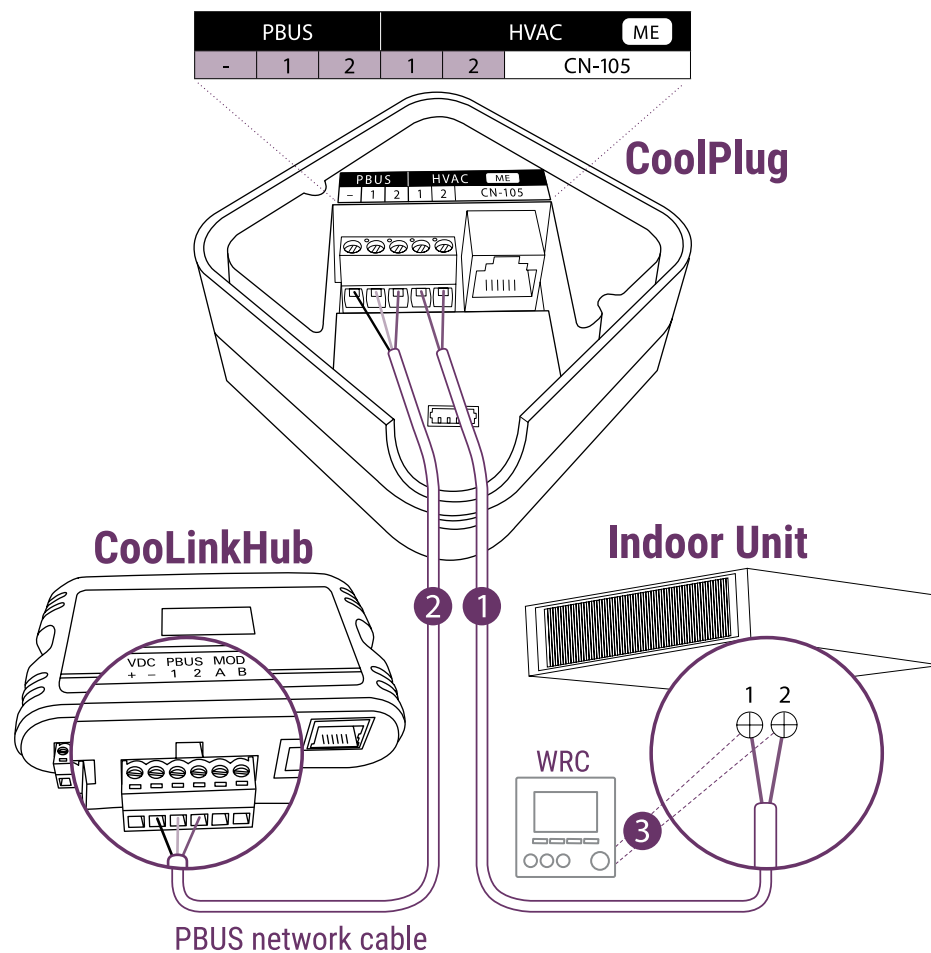

Both PBUS and HVAC line have the same terminal labels [1] and [2], but they belong to different networks. They should not be interchanged.

Connecting CoolPlug ME (Mitsubishi Electric)

ME (Mitsubishi Electric) – When connecting to CN-105

1 Connecting the CoolPlug to the Mitsubishi Electric Indoor Unit

Connect the CN-105 cable (supplied with the CoolPlug) between the CoolPlug RJ-11 connector and the CN-105 port on the indoor unit's PCB. Use the manufacturer's installation manual for the location of the CN105 connector on the PCB of the indoor unit.

2 Connecting the CoolPlug to the CoolLinkHub

Wireless Mode: Check the devices were paired successfully. See how to pair on [page 35](#).

Wired Mode: Connect the signal wires of the PBUS cable, using the [VDC-], [1] and [2] terminals on the CoolLinkHub, to the corresponding [-], [1] and [2] terminals on the CoolPlug.

Please refer to the PBUS connection diagram on [page 6](#).

3 Optional: For connecting the Wired Remote Controller (WRC) in parallel mode with CoolPlug, the CN105 Splitter 4 is required. (This part can be purchased from CoolAutomation).

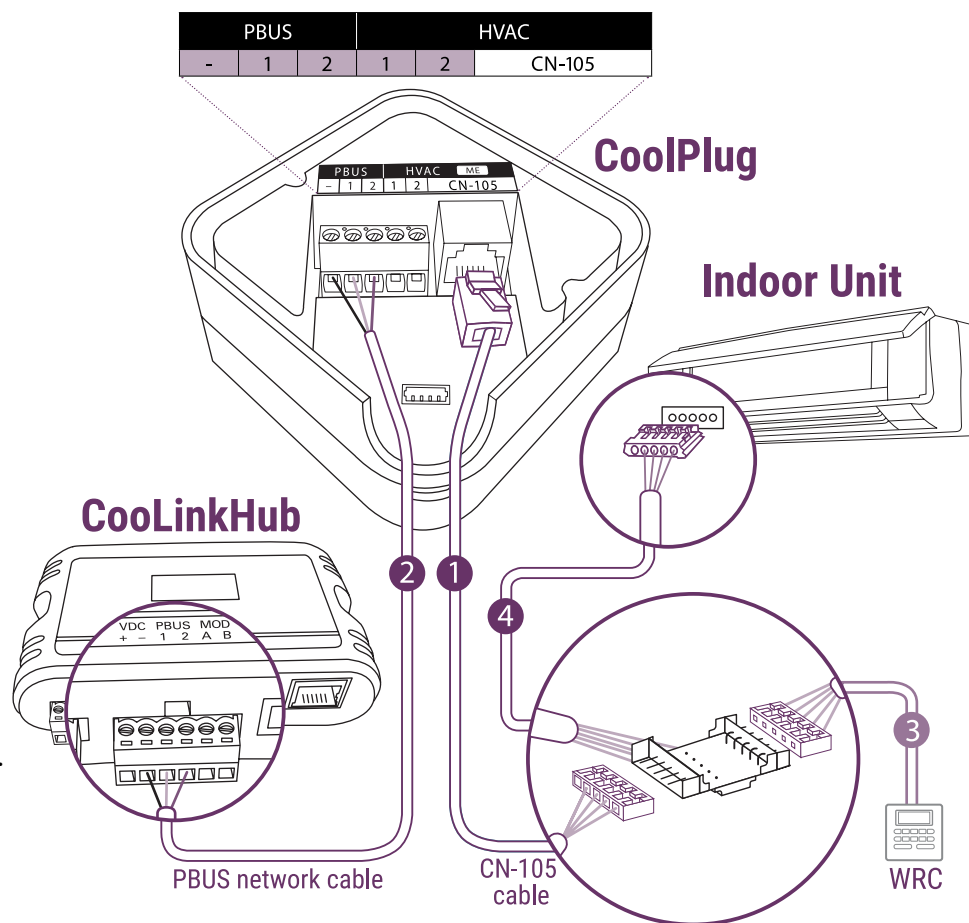

** Master/Slave configuration will be done by the CoolPlug automatically.

Connecting CoolPlug MH (Mitsubishi Heavy)

1 Connecting the CoolPlug to the Mitsubishi Heavy Indoor Unit

Connect the CoolPlug's [X] [Y] terminals to the [X], [Y] terminals on the indoor unit accordingly. Use the manufacturer's installation manual for the location of the [X] [Y] terminals on the indoor unit.

2 Connecting the CoolPlug to the CoolLinkHub

Wireless Mode: Check the devices were paired successfully. See how to pair on [page 35](#).

Wired Mode: Connect the signal wires of the PBUS cable, using the [VDC-], [1] and [2] terminals on the CoolLinkHub to the corresponding [-], [1] and [2] terminals on the CoolPlug.

Please refer to the PBUS connection diagram on [page 6](#).

3 Optional: WRC can be connected in parallel to the CoolPlug.

* The connection is nonpolar.

** Master/Slave configuration will be done by the CoolPlug automatically.

*** Some of the wall mounted series do not have terminals for WRC. To have CoolPlug connected to this unit, an additional (SC-BIK-E) adapter might be required. This adapter can be purchased locally from any Mitsubishi Heavy distributor.

**** When using E-BIK-S adapter, it will only work when WRC is also connected.

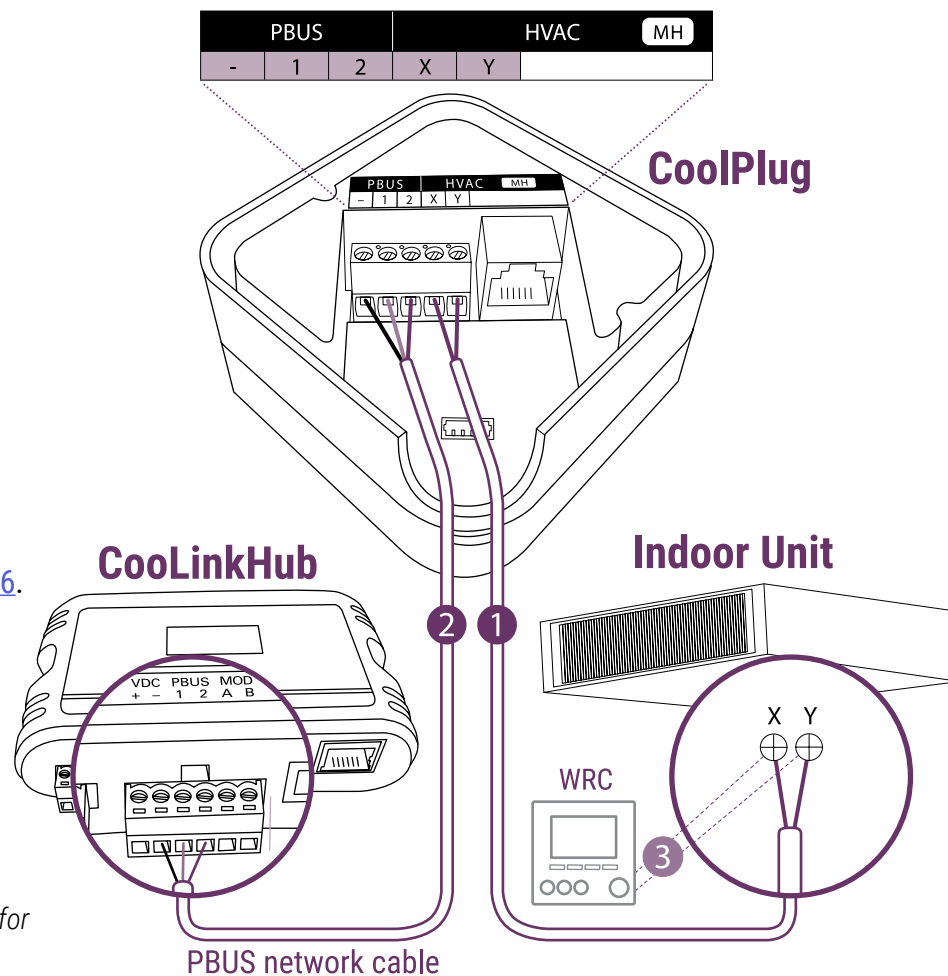

Connecting CoolPlug HT (Hitachi)

- 1 Connecting the CoolPlug to the Hitachi indoor unit (for VRF indoor units only)

Connect the CoolPlug's [A] [B] terminals to the [A], [B] terminals on the indoor unit accordingly.

- 2 Connecting the CoolPlug to the CoolLinkHub

Wireless Mode: Check the devices were paired successfully. See how to pair on [page 35](#).

Wired Mode: Connect the signal wires of the PBUS cable coming from the [VDC-], [1] and [2] terminals on the CoolLinkHub to the corresponding [-], [1] and [2] terminals on the CoolPlug.

Please refer to the PBUS connection diagram on [page 6](#).

- 3 Optional: WRC can be connected in parallel to the CoolPlug.

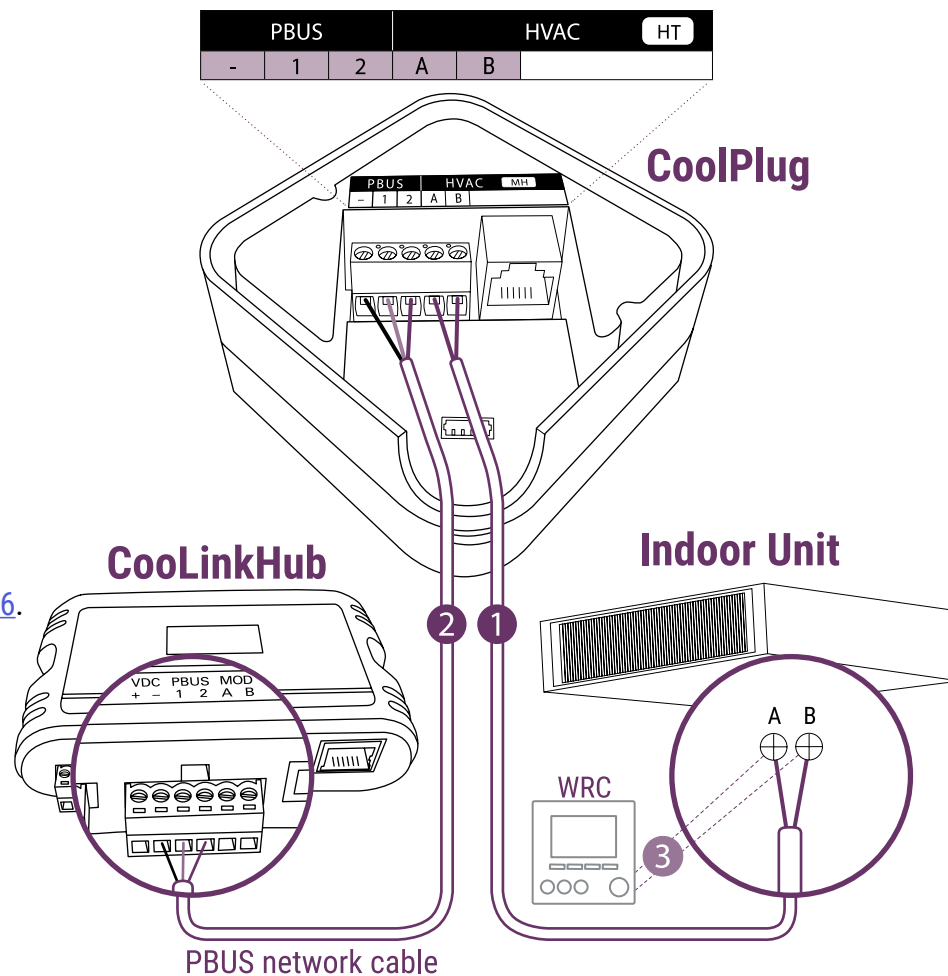

* The connection is nonpolar.

** Master/Slave configuration will be done by the CoolPlug automatically.

Connecting CoolPlug LG (LG)

- 1** Connecting the CoolPlug to the Indoor unit
Connect the cable (supplied with the CoolPlug) between the CoolPlug [Y] [B] [R] and CN-REMO on the indoor unit's PCB or on the cable. Use the HVAC manufacturer's installation manual to locate the required terminals on the indoor.
- 2** Connecting the CoolPlug to the CoolLinkHub
Wireless Mode: Check the devices were paired successfully. See how to pair on [page 35](#).
Wired Mode: Connect the signal wires of the PBUS cable between CoolPlug terminals [-], [1] and [2], and CoolLinkHub terminals [VDC-], [1] and [2], respectively. Please refer to the PBUS connection diagram on [page 6](#).
- 3** **Optional:** Connect the Wired Remote Controller (WRC) to the connector on the cable supplied with CoolPlug.

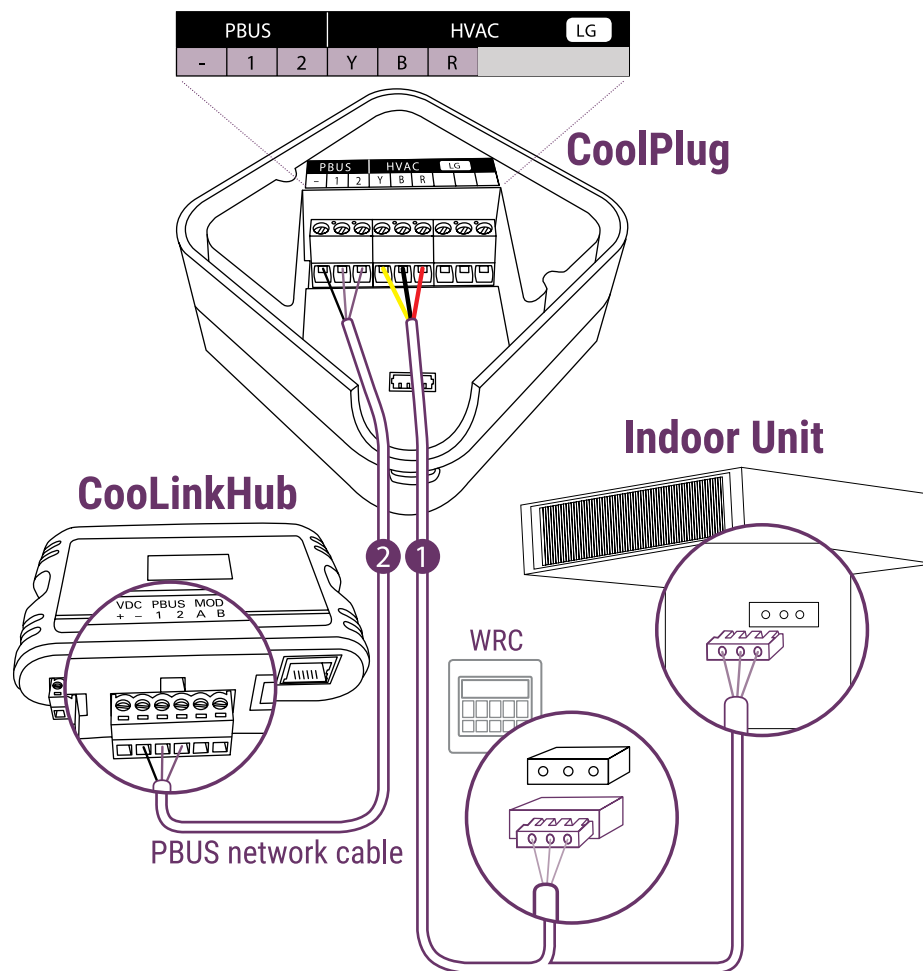

Connecting CoolPlug MD (Midea)

(Midea VRF or CAC only, except of Midea MV6 series)

1 Connecting the CoolPlug to the Indoor unit

Connect the CoolPlug's [X] [Y] [E] terminals to the [X] [Y] [E] terminals on the indoor unit accordingly. Note, that [E] terminal in CoolPlug stands for electrical COMMON and is located on the right side of CoolPlug's terminal. Use the HVAC manufacturer's installation manual to find the corresponding terminals on the indoor unit.

2 Connecting the CoolPlug to the CoolLinkHub

Wireless Mode: Check the devices were paired successfully. See how to pair on [page 35](#).

Wired Mode: Connect the signal wires of the PBUS cable between CoolPlug terminals [-], [1] and [2], and CoolLinkHub terminals [VDC-], [1] and [2], respectively. Please refer to the PBUS connection diagram on [page 6](#).

* CoolPlug MD is not powered directly from the HVAC indoor unit, so external 12Vdc power supply is required.

** Wired version - CoolPlug is powered by power supply from CoolLinkHub (Figure 1 below).

*** Wireless version - with external power supply (figure 2 below).

Figure 1 – CoolPlug powered by CoolLinkHub

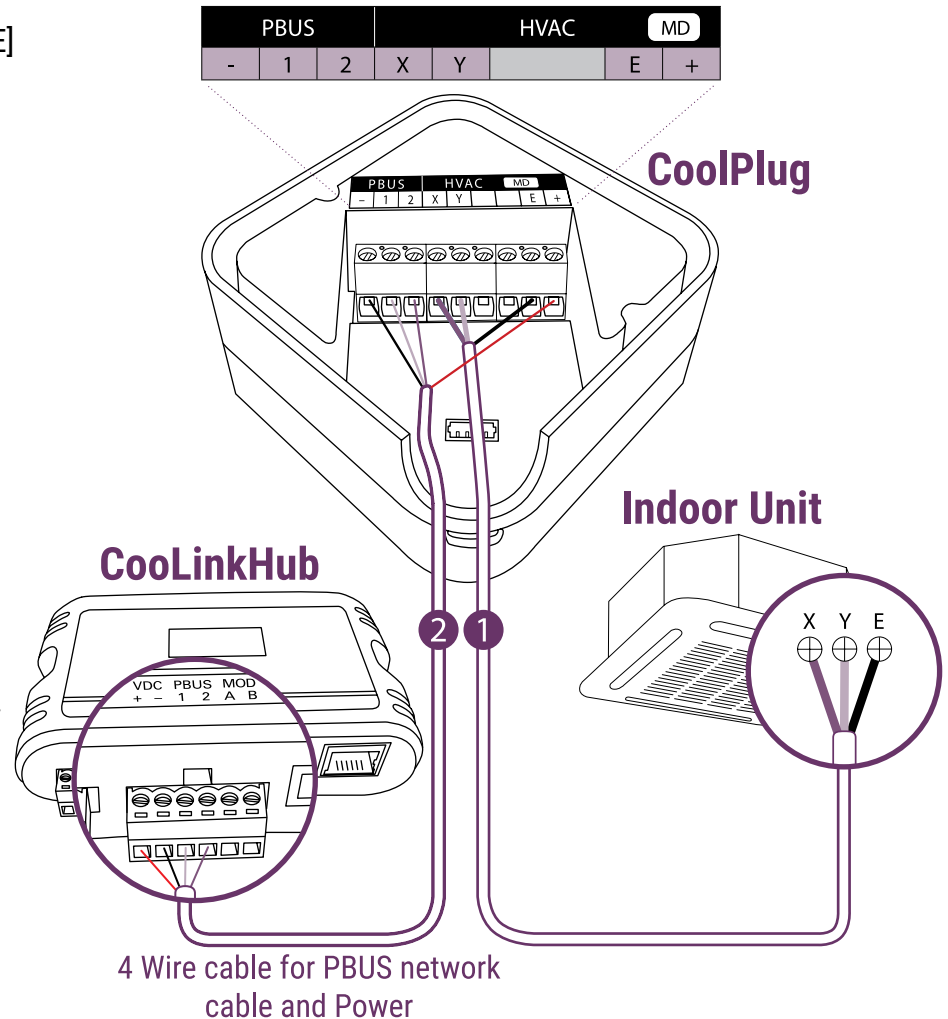
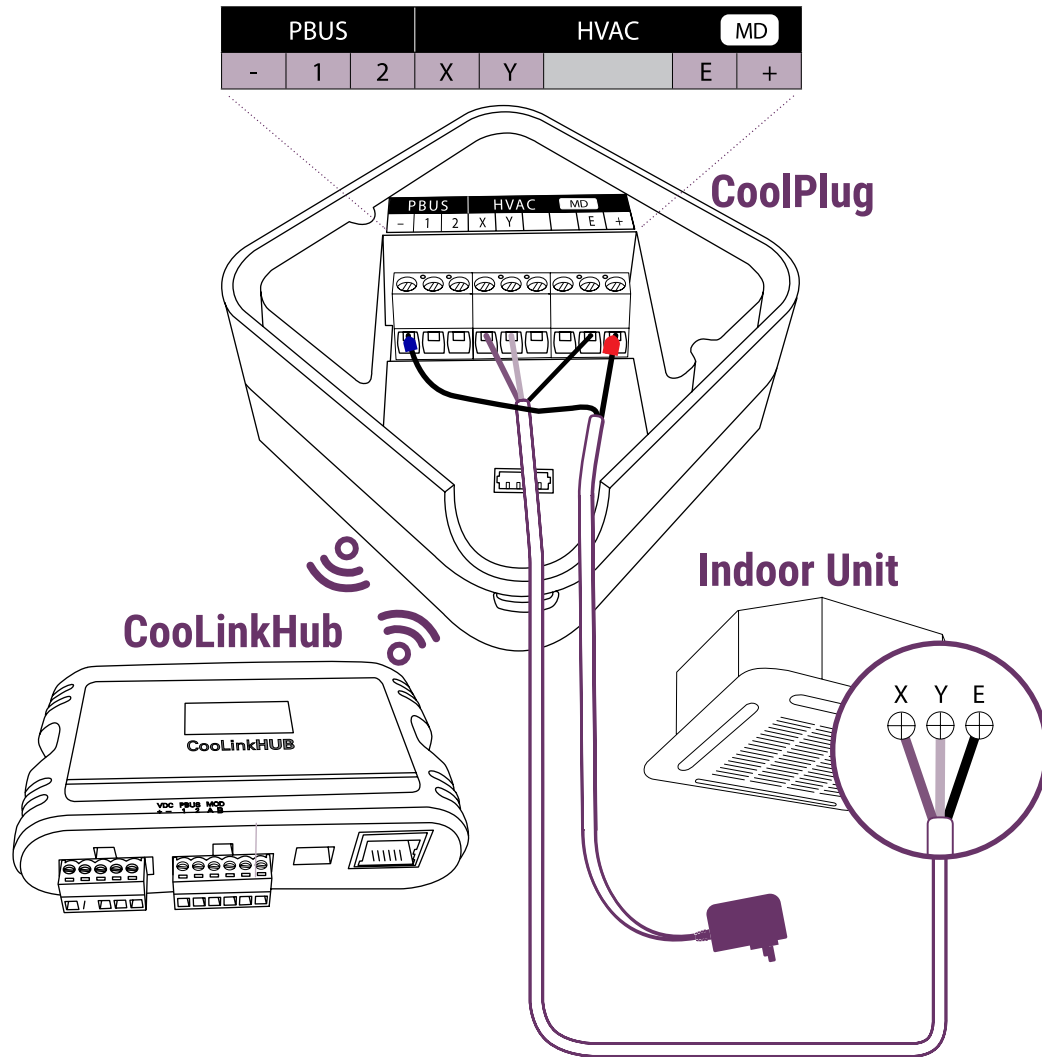

Figure 2 – CoolPlug WRLS - with individual external power supply



Connecting CoolPlug GRTS (Gree)

Gree GRTS - Option 1: When WRC connect to Indoor Units Board

1 Connecting the CoolPlug HVAC Line to the Gree Indoor Unit

Connect the cable (supplied with the CoolPlug) between the CoolPlug Indoor connector and the connector on the indoor unit's PCB. Use the HVAC manufacturer's Installation manual for the location of the connector on the indoor unit's PCB.

2 Connecting the CoolPlug to the CoolLinkHub

Wireless Mode: Check the devices were paired successfully. See how to pair on [page 35](#).

Wired Mode: Connect the signal wires of PBUS cable between the CoolPlug terminals [-], [1] and [2], and the CoolLinkHub terminals [VDC-], [1] and [2], respectively. Please refer to the PBUS connection diagram on [page 6](#).

3 Connecting the CoolPlug to the WRC

Connect the short cable (supplied with the CoolPlug) to 2 connectors on the WRC ports. Connect the long WRC cable (supplied with the WRC) to the other end of the short cable on one side, and to the CoolPlug on the other.

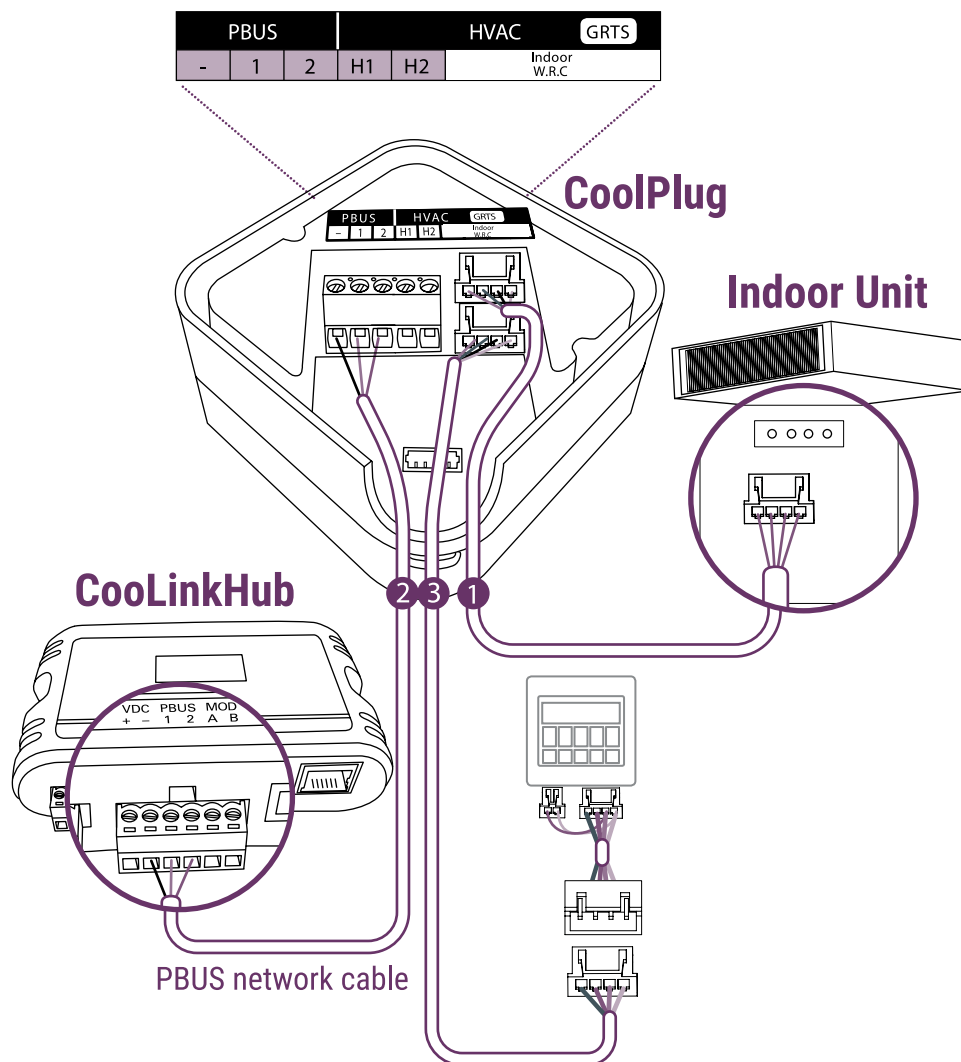

Connecting CoolPlug GRTS (Gree)

Gree GRTS - Option 2: When WRC Connect to Indoor Unit Cable

- 1 Connecting the CoolPlug HVAC line to the Gree Indoor Unit

Connect the cable (supplied with the CoolPlug) between the CoolPlug Indoor connector and the connector on the indoor unit's cable. Use the HVAC manufacturer's Installation Manual for the location of the required socket on the indoor unit.

- 2 Connecting the CoolPlug to the CoolLinkHub

Wireless Mode: Check the devices were paired successfully. See how to pair on [page 35](#).

Wired Mode: Connect the signal wires of the PBUS network cable between CoolPlug terminals [-], [1] and [2], and CoolLinkHub terminals [VDC-], [1] and [2], respectively.

Please refer to the PBUS connection diagram on [page 6](#).

- 3 Connecting the CoolPlug to the WRC

Connect the short cable (supplied with the WRC) between the 2 WRC ports. Connect the long WRC cable to the connector of the adapter cable supplied with the CoolPlug. Then connect the CoolPlug adapter to the CoolPlug WRC port.

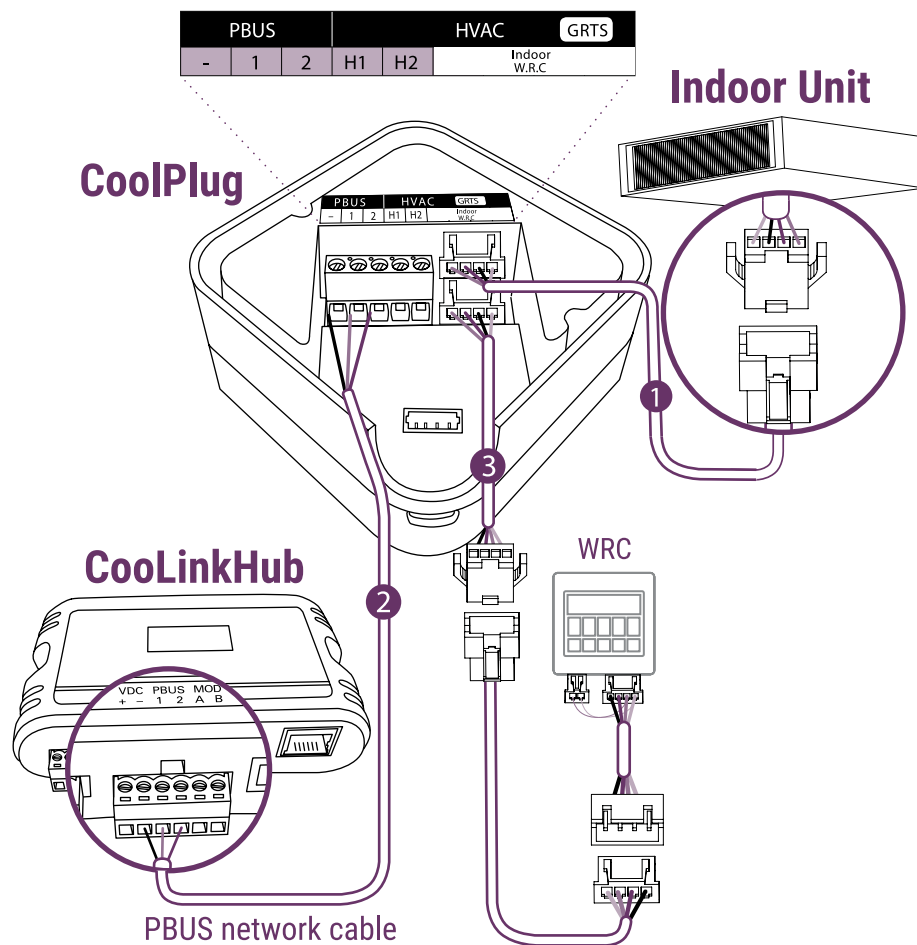

Connecting CoolPlug GRTS (Gree)

Gree GRTS - Option 3: 2 wires

- 1 Connecting the CoolPlug HVAC line to the Gree Indoor Unit

Connect the CoolPlug's [H1] [H2] terminals to terminals [H1] and [H2] on the indoor unit PCB accordingly. Use the HVAC manufacturer's Installation Manual for the location of the connection terminals on the indoor PCB.

- 2 Connecting the CoolPlug to the CoolLinkHub

Wireless Mode: Check the devices were paired successfully. See how to pair on [page 35](#).

Wired Mode: Connect the signal wires of the PBUS network cable, using [VDC-], [1] and [2] terminals on the CoolLinkHub to the corresponding [-], [1] and [2] terminals on the CoolPlug.

Please refer to the PBUS connection diagram on [page 6](#).

- 3 Optional: Connect the WRC by [H1] [H2] terminals in parallel to the CoolPlug.

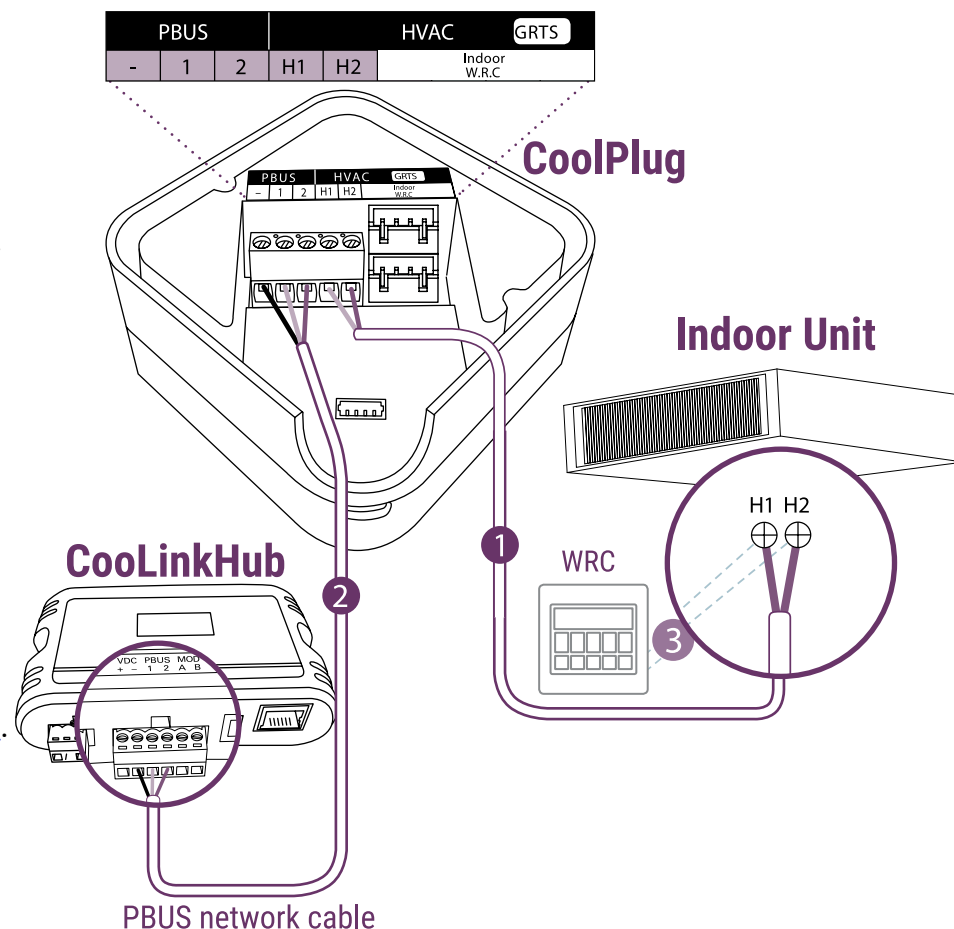

* The connection is nonpolar.

** Master/Slave configuration will be done by the CoolPlug automatically.

Connecting CoolPlug GR (Gree VRF GMV5)

Gree VRF GMV5 only

1 Connecting the CoolPlug HVAC line to the Gree Indoor Unit

Connect the CoolPlug's [H1] [H2] terminals to terminals [H1] and [H2] on the indoor unit PCB accordingly. Use the HVAC manufacturer's Installation Manual for the location of the connection terminals on the indoors PCB.

2 Connecting the CoolPlug to the CoolLinkHub

Wireless Mode: Check the devices were paired successfully. See how to pair on [page 35](#).

Wired Mode: Connect the signal wires of the PBUS network cable, using [VDC-], [1] and [2] terminals on the CoolLinkHub to the corresponding [-], [1] and [2] terminals on the CoolPlug.

Please refer to the PBUS connection diagram on [page 6](#).

3 Optional: Connect the WRC by [H1] [H2] terminals in parallel to the CoolPlug.

* The connection is nonpolar.

** Master/Slave configuration will be done by the CoolPlug automatically.

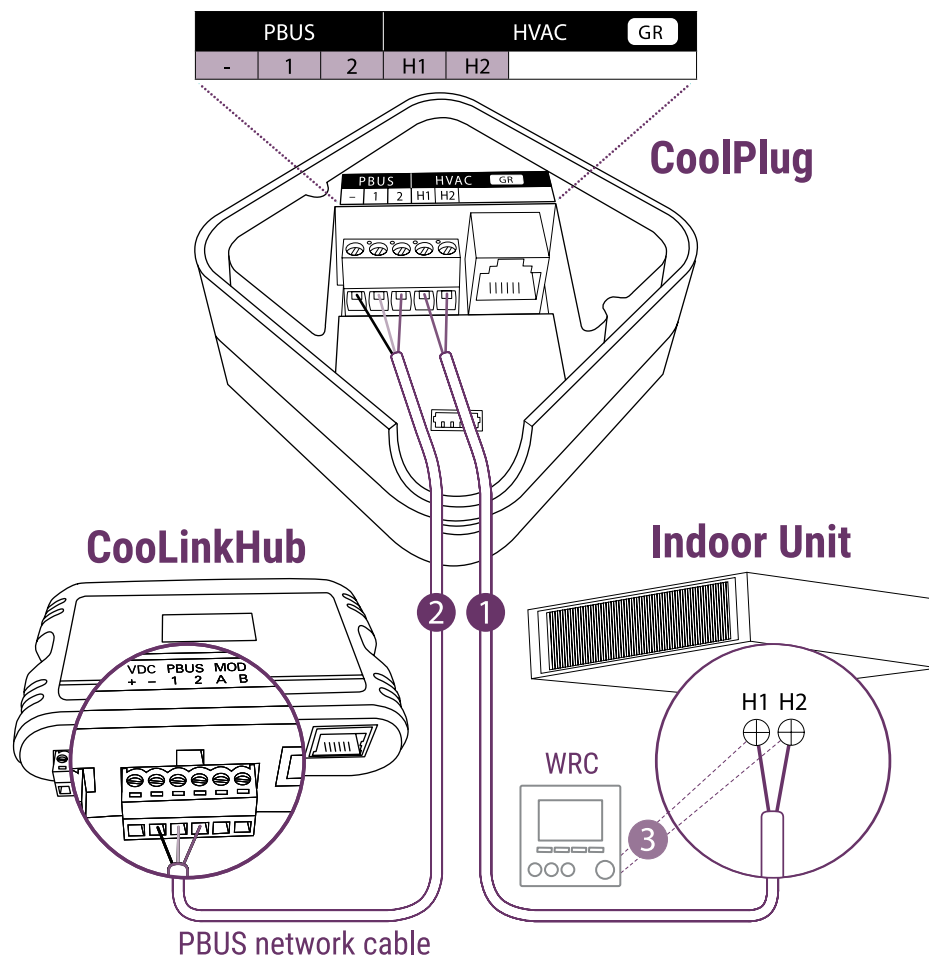

Connecting CoolPlug SM (Samsung)

Samsung - Option 1: 2 wires

- 1** Connecting the CoolPlug to the Samsung unit
Connect the CoolPlug's VRF [F3], [F4] terminals to the [F3], [F4] terminals on the indoor unit. Use HVAC manufacturer's Installation Manual for instructions on the location of [F3], [F4] terminals on the Samsung unit.
- 2** Connecting the CoolPlug to the CoolLinkHUB
Wireless Mode: Check the devices were paired successfully. See how to pair on [page 35](#).
Wired Mode: Connect the signal wires of the PBUS cable coming from the [VDC-], [1] and [2] terminals on the CoolLinkHUB to the corresponding [-], [1] and [2] terminals on the CoolPlug, respectively.
Please refer to the PBUS connection diagram on [page 6](#).
- 3** Optional: Connect WRC in parallel with CoolPlug.

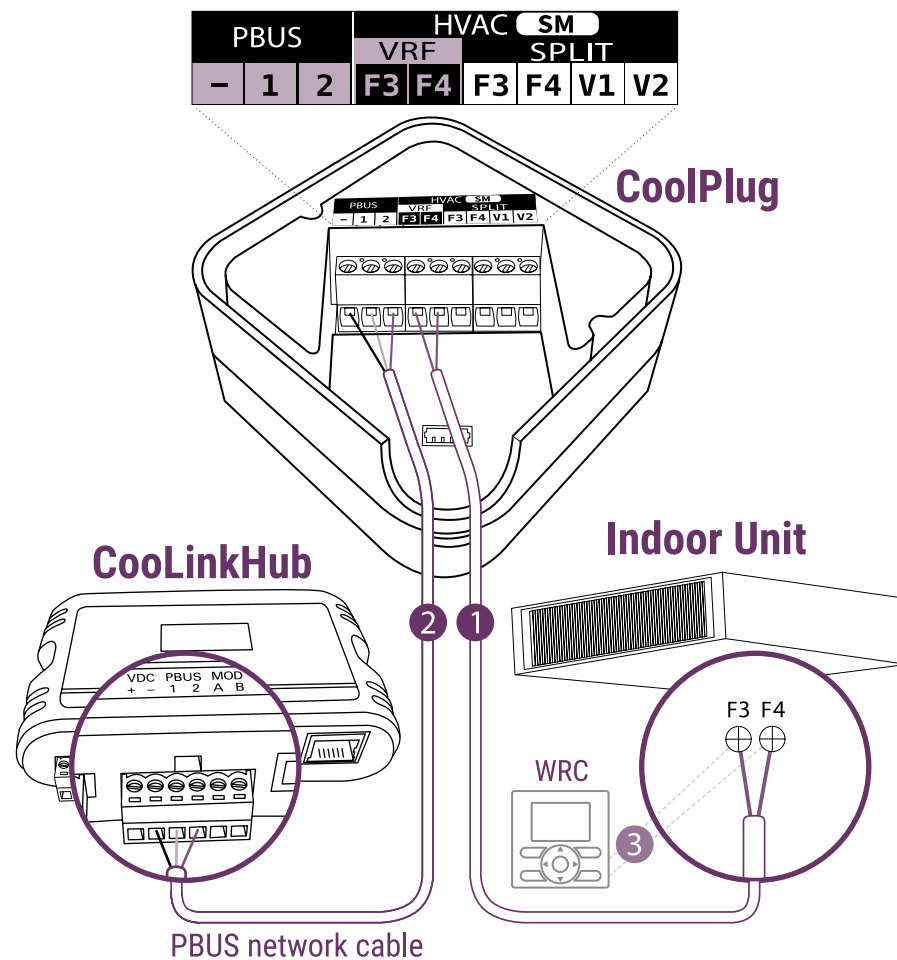

* The connection is nonpolar.

** Master/Slave configuration will be done by the CoolPlug automatically.

Connecting CoolPlug SM (Samsung)

Samsung - Option 2: 4 wires

- 1** Connecting the CoolPlug to the Samsung indoor unit
Connect the CoolPlug's SPLIT [F3] [F4] terminals to the [F3] [F4] terminals on the indoor unit accordingly, and CoolPlug's [V1] [V2] terminals to the [V1] [V2] terminals on the indoor unit. Use HVAC manufacturer's Installation Manual for instructions on the location of [F3][F4] and [V1] [V2] terminals on the Samsung unit.
- 2** Connecting the CoolPlug to the CoolLinkHUB
Wireless Mode: Check the devices were paired successfully. See how to pair on [page 35](#).
Wired Mode: Connect the signal wires of the PBUS cable coming from the [VDC-], [1] and [2] terminals on the CoolLinkHUB to the corresponding [-], [1] and [2] terminals on the CoolPlug, respectively.
Please refer to the PBUS connection diagram on [page 6](#).
- 3** **Optional:** Connect WRC in parallel with the CoolPlug.

* The paired connections(F3/F4 and V1/V2) are nonpolar.

** Master/Slave configuration will be done by the CoolPlug automatically.

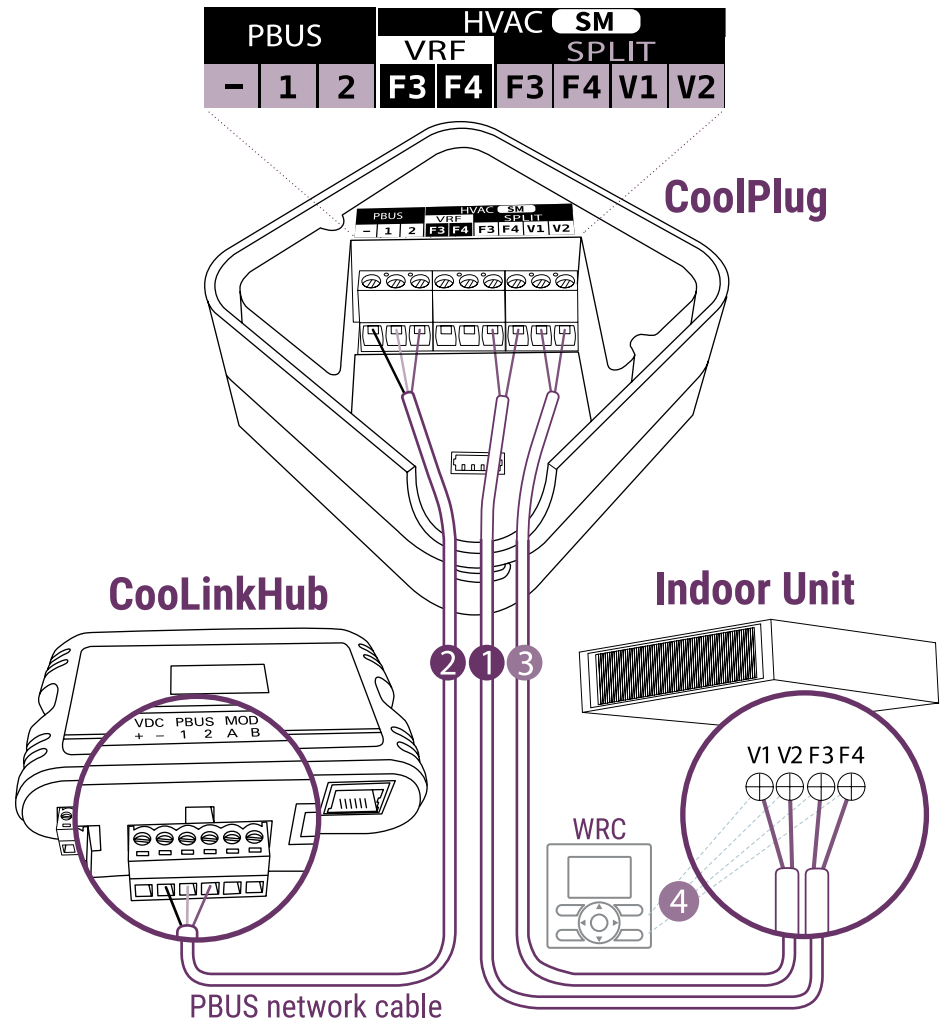

Connecting Home Automation, BMS & Control App

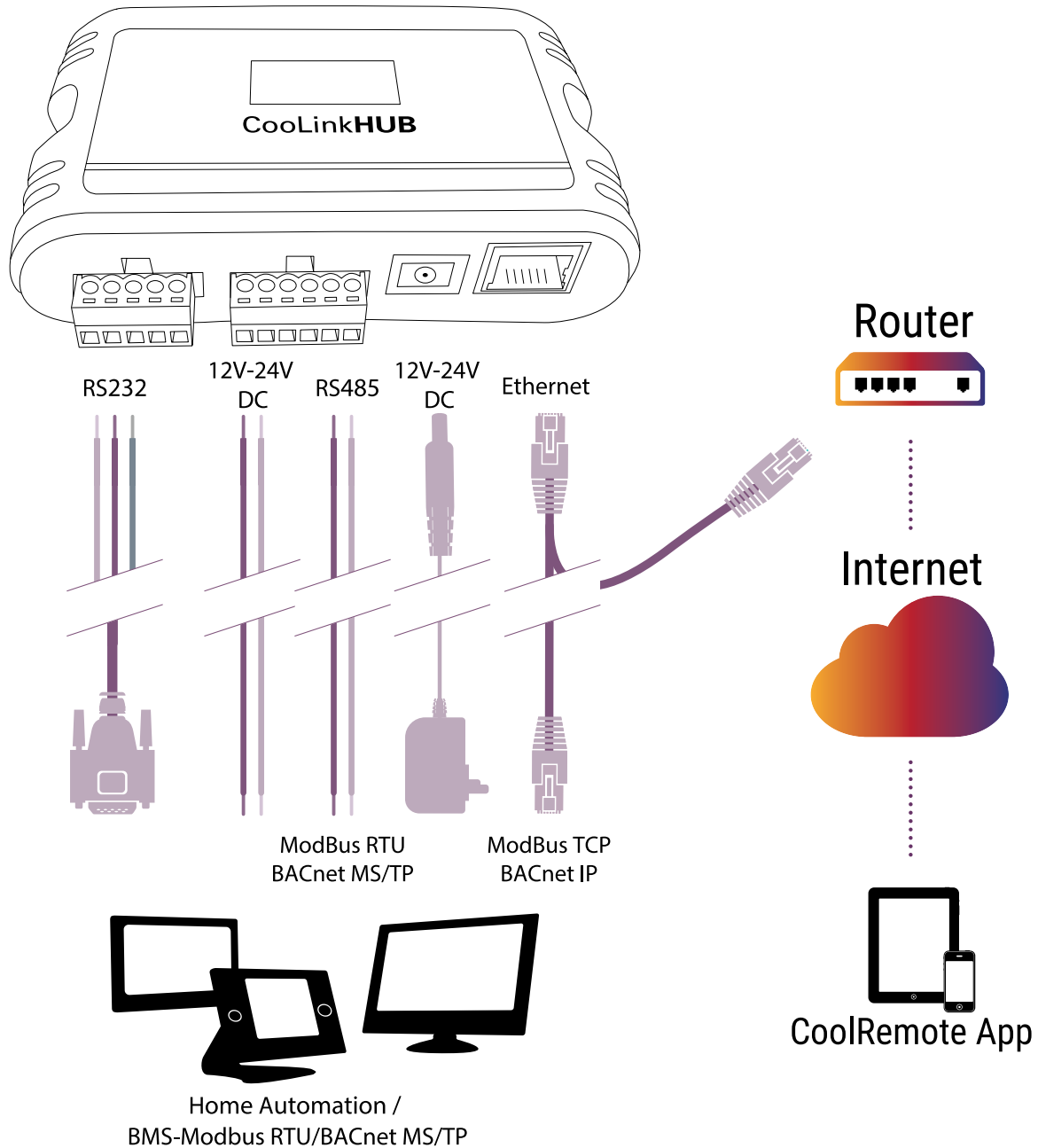

Control App

Connect the device to the Internet for registration and setup.

Option A – Automatic process

- 1 Scan the QR code from the type label to auto fill-in all the CoolLinkHub details for the Control App.

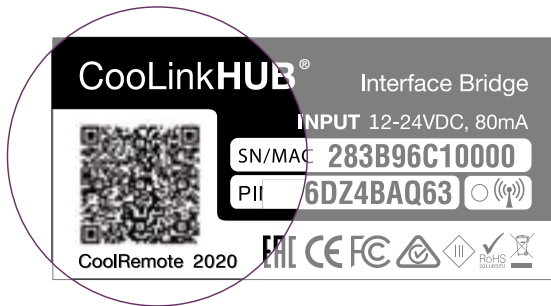

- 2 Register your username (email) and password to remotely control and monitor all of your connected HVAC units.

Option B – Manual process

- 1 Open: <https://control.coolremote.net/device-registration>. Enter the CoolLinkHub SN number and PIN code, printed on the sticker.

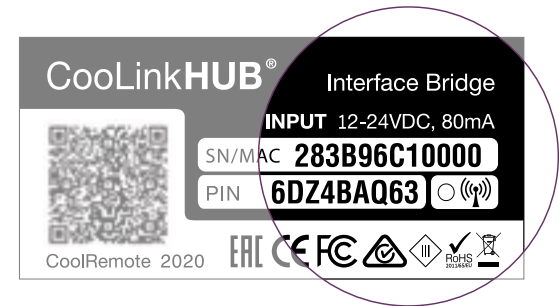

- 2 Register your username (email) and password to remotely control and monitor all of your connected HVAC units.

CoolPlug Operation

CoolPlug Indicators

The three LEDs that surround the CoolPlug's push-button provide information about the CoolPlug configuration and status. The CoolPlug is powered on, the Firmware version is displayed by flashing LEDs followed by the operational state of the system.

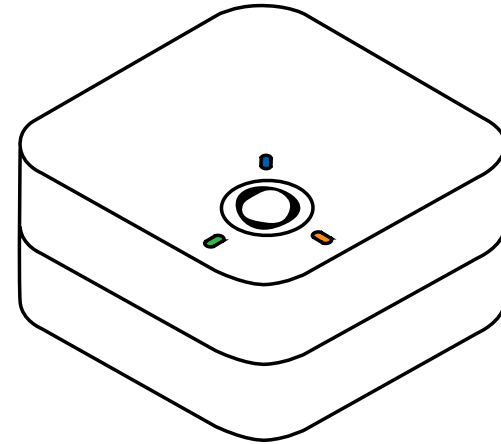

CoolPlug Normal Operation

In normal operation the blue LED blinks periodically. The green and amber/red LEDs are not lit.

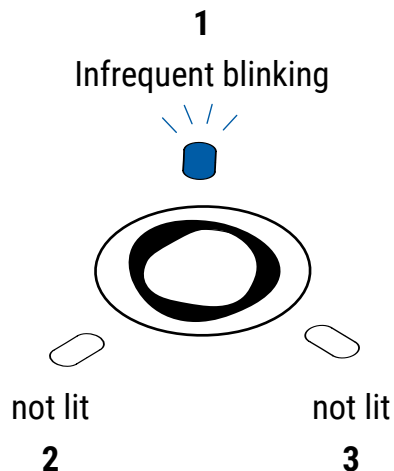

Pic.	LED's Color	Normal operation	Problems	
		LED OFF	LED ON	LED blinking
2	Green	HVAC Line OK	HVAC Line not connected	HVAC Line errors
3	Amber	PBUS OK	PBUS not connected	PBUS errors
(for wired connection only)				
3	Red	Wireless OK	Wireless no connected	Look on page 35
(for wireless connection only)				
1	Blue	Blinks infrequently twice HVAC is ON		
		Blinks infrequently HVAC is ON		

Determining the CoolPlug UID

The CoolPlug UID is flashed after one 'Short' press on the CoolPlug push-button.

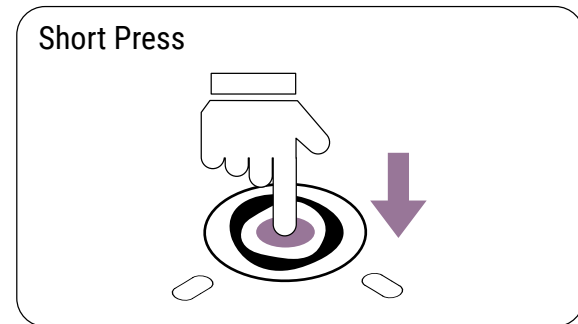

Toggling the HVAC ON/OFF

Toggle the HVAC state ON/OFF with one 'Long' press for 2-3 seconds on the CoolPlug push-button.

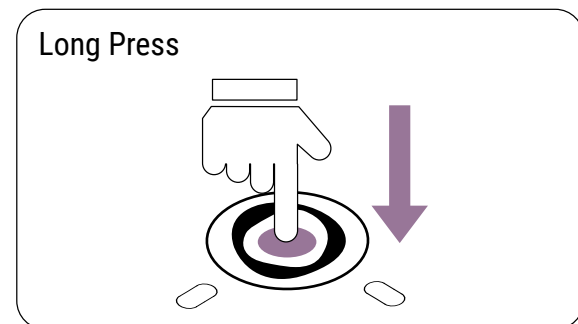

Resetting the CoolPlug

Reset the CoolPlug with one 'Short' press followed by one 'Long' press on the CoolPlug push-button.

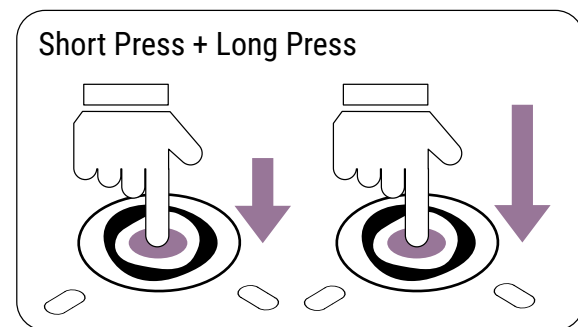

Wireless CoolPlug & CoolLinkHub – Installation Guidelines

Important Notes:

- 1 To successfully pair the CoolLinkHub Wireless (WRLS) to the CoolPlug Wireless (WRLS) they must be in line of sight proximity one to the other (no more than three meters).
- 2 The CoolPlug WRLS is powered from the HVAC terminal. It can also be powered via USB during the setup process (either from a PC or the CoolLinkHub WRLS).
- 3 The CoolLinkHub WRLS can connect simultaneously to both wired and wireless CoolPlug units.

How to pair and connect a CoolPlug WRLS with the CoolLinkHub WRLS

- 1 On the CoolLinkHub WRLS, press the OK button.
- 2 The CoolPlug WRLS is powered from the HVAC terminal. It can also be powered via USB during the setup process (either from a PC or the CoolLinkHub WRLS).
- 3 With the up/down arrow buttons, select the Wireless option.
- 4 Press the **OK** button. A new options menu is displayed on the screen.
- 5 With the arrow buttons select the **Pair** option.

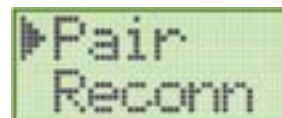
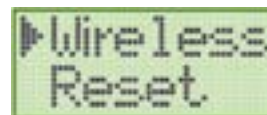
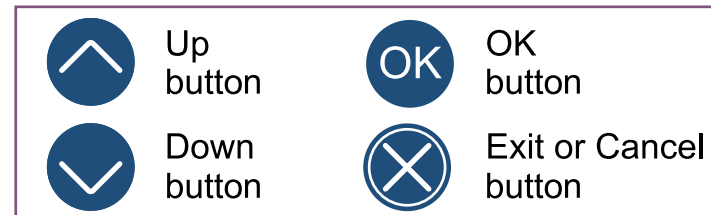

- 6 On the CoolPlug WRLS, press the button **five times** (take 1 second between consecutive presses). A fast blinking red light is displayed while pairing to the CoolLinkHub WRLS.

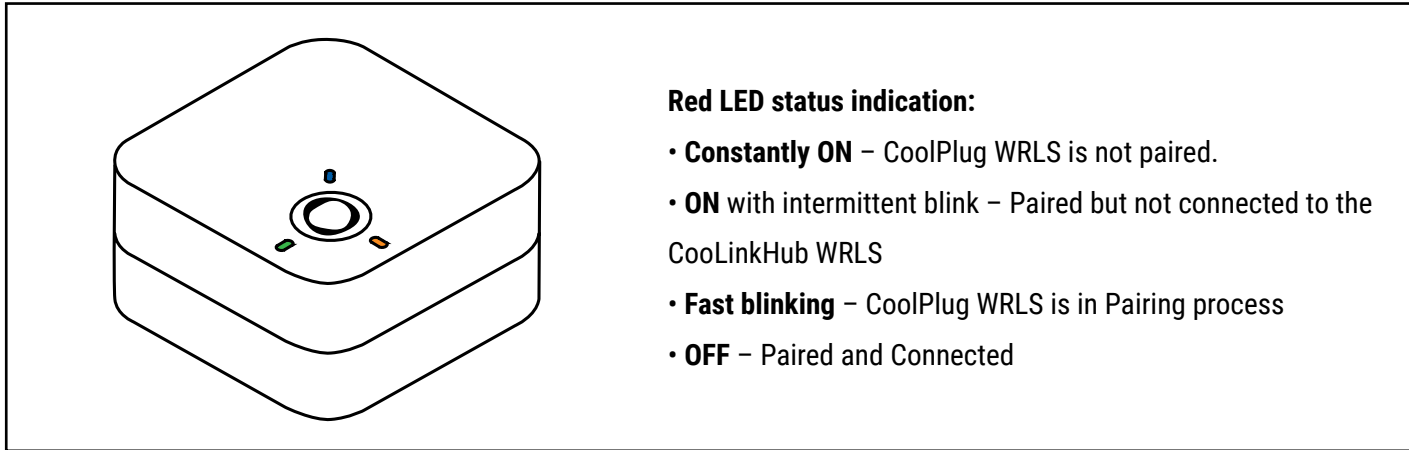

- 7 On the CoolLinkHub WRLS, press the OK button.
- 8 When pairing is complete, the red LED turns off.
- 9 When pairing is complete, the CoolPlug WRLS immediately tries to connect to the CoolLinkHub WRLS.
- 10 Once the connection is successful, the number of connected CoolPlugs WRLS is displayed on the screen in L5 GXXX, where XXX denotes a number (in the image below XXX=5).
- 11 The devices are now paired and connected.

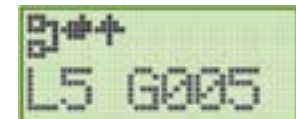

Rebuilding the wireless mesh network

In some cases, rebuilding the mesh network topology may be required. For example, when changing the position of the number of CoolPlugs WRLS.

To ensure the network is built in the most optimal way, follow the reconnection procedure:

To reconnect all paired devices to the wireless network mesh:

- 1 On the CoolLinkHub WRLS, press the **OK** button. An options menu is displayed on the screen.

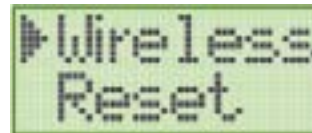

- 2 With the arrow buttons select the **Wireless** option.

- 3 Press the **OK** button. A new options menu is displayed on the screen.

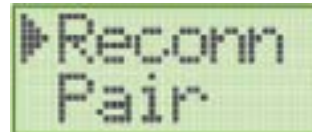

- 4 With the arrow buttons select the **Reconn** option.

- 5 Press the **OK** button.

- 6 Upon successful reconnection, the expected number of CPs is displayed on the screen in L5 GXXX (as in the image below).

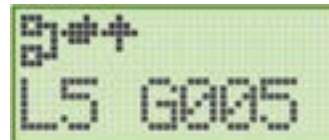

* To reconnect devices, no actions need to be performed on the CoolPlug WRLS devices.

Mounting the CoolPlug

On a Metal Surface

The CoolPlug flat back plate has place for two sticky bands that allow you to mount it on the plastic or stick two magnets for mounting it on any metal surface.

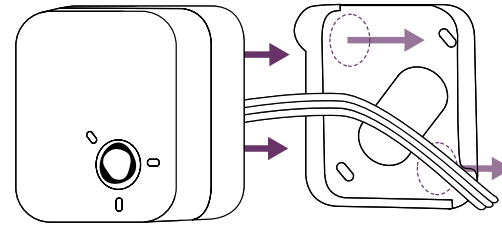

On the Wall

Attach the CoolPlug back plate to the wall, using screws as shown. The wires can be inserted through the hole in the center of the cover or from the side as shown.

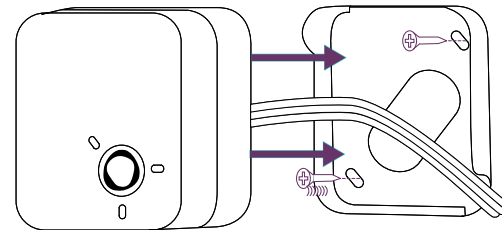
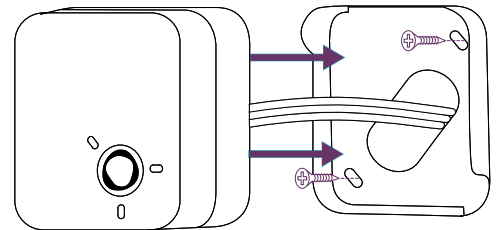

On a DIN Rail

Use the DIN rail back plate of the CoolPlug to attach it to the DIN rail utilizing magnets.

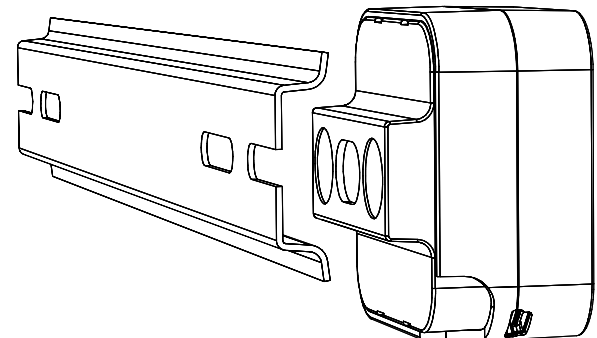
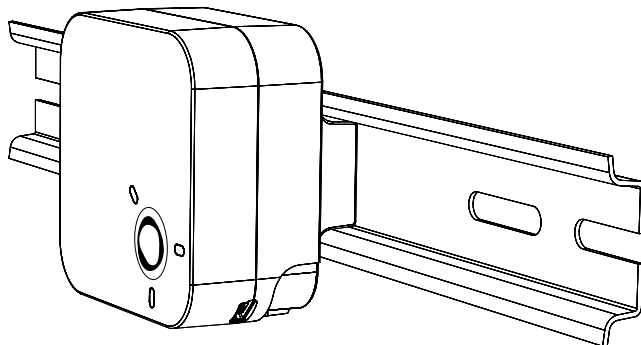

Need more help?

Visit us at: <https://coolautomation.com/support>



COOLAUTOMATION
THE INTERNET OF CLIMATE