

SHENZHEN ATTEN TECHNOLOGY CO., LTD.

- Soldering Iron ●Soldering Station ●Hot Air Rework Station ●Multi-function Rework System
- BGA Rework Station
- Regulated DC Power Supply ●Switching DC Power Supply ●Programmable Power Supply

ATTEN

PR35-3A-3C / PR35-5A-3C

Three-Channels Regulated DC Power Supply

User's Manual

SHENZHEN ATTEN TECHNOLOGY CO., LTD.

Address: 8F, Building 2, Senyang High-tech Park,
No.7 Road, Guangming New District, Shenzhen,
Guangdong Province, China.

Tel: +86 755-2697 6387

Fax: +86 755-8602 1337 Zip Code: 518132

Website: www.atten.com.cn (Chinese)

www.atten.com (English)

Email address: sales@atten.com.cn

THE NO.1

[INSTRUMENTS BRAND

IN CHINA]

All Copyright Reserved

MADE IN CHINA

CBN027860 (D)

Shenzhen ATTEN Technology Co., Ltd.

Fault Description	Assumption of Fault Causes	Solutions
There is no response after pressing the serial and parallel connection conversion key SEL.	Check whether the SET key, OVP/OCP key and OUTPUT key are on and whether the LOCK lamp is on.	Press the light-on key again to unlock the state

Solution to the alarm fault when the power output is ON

Fault Description	Assumption of Fault Causes	Solutions
ALARM lamp is lighting on when the power output is ON.	Check whether the value of OVP is less than the output voltage value.	Increase the value of OVP.
	Check whether the value of OCP is less than the output current value.	Increase the value of OCP.
	Check whether the internal temperature of the machine rises abnormally.	Check whether the machine is in thermal protection state, confirm the operating temperature and whether the air suction port is blocked or the fan has stopped working.
Alarm is given only after the load is replaced.	Check whether high voltage is applied from the outside such as the battery load.	Check whether the machine has been in OVP / OCP state or whether the machine is overloaded.
	Check whether the set voltage displayed on the panel is higher than the actual output voltage.	

After-sales Contact

Telephone of After-sales Service Department: 0755-26977372-817

Product Warranty Card

This product is guaranteed for twenty-four months from the date of purchase. If any quality problem is found within the warranty period, we will be responsible for the maintenance free of charge on presentation of this card and the receipt. We will repair and return the repaired equipment to the customer within 2 working days following the receipt date.

Note: This warranty card must be attached when this product is returned to the factory for maintenance; otherwise, free maintenance will not be accepted. Thanks for your cooperation!

Appendix

Appendix A – Common Faults and Solutions

The following lists some common faults of the machine and simple solutions; if the user still fails to solve the faults after having tried these simple solutions, please contact ATTEN or our dealer.

Poor contact of power supply

Fault Description	Trouble Shooting	Solutions
The machine makes no response after the power switch is switched.	Check whether the connection of power line is open-circuited.	Please connect the power line correctly or replace it.

No power output

Fault Description	Assumption of Fault Causes	Solutions
There is no output even after the power output is switched to the open state.	The output voltage or output current has been set to 0.	Turn the rotary knob, and set the output voltage and output current to the required value.
After the power output is switched to the open state, and the output is displayed for a short time, the power output is switched to the closed state immediately.	Check whether the machine enters over-voltage protection mode.	Set OVP to be higher than the set voltage.
	Check whether the machine enters over-heating protection mode.	Confirm the operating temperature or check whether the air suction port is blocked.

Unstable output

Fault Description	Assumption of Fault Causes	Solutions
When the power output is ON, if turning the VOLTAGE or CURRENT rotary knob, unstable output occurs.	Check whether the machine is in the process of switching from CV to CC or from CC to CV.	Change the setting of CC or CV to make it greater than the current set value. If the set value has been the maximum value, use the power supply with higher output voltage or current.
The output voltage or output current is changing.	Check whether the load current has peak value, and whether the load current is in pulse state.	The peak value of load current might be greater than the set value of constant current. Please increase the set value of constant current, or increase the current capacity.
The output voltage has deviation from the output value when the power supply is just turned on.	Check whether it is more than 30min after power supply is turned on.	Please warm up (electrify) the machine for at least 30min.

High output ripple

Fault Description	Assumption of Fault Causes	Solutions
The ripple voltage increases sometimes.	Check whether the input voltage exceeds the range.	Please input the input voltage within the range.
The pulse becomes big due to the change of installation site.	Check whether there is generation source of strong magnetic field or electric field nearby.	Keep the product far away from the generation source, or solve the problem by twisting the load wire.

Failure to operate the switch on the panel

Fault Description	Assumption of Fault Causes	Solutions
The switch on the panel cannot be operated.	Check whether LOCK LED is on.	Please unlock the panel. (Press and hold the FINE key and then press the LOCK key)

Fail to switch independent, serial and parallel connection states

Contents

After-sales Contact.....	2
Appendix.....	3
Copyright Information.....	4
Symbol Description.....	4
Safety Precautions.....	4
Technical Specification of PR Series:.....	5
Disclaimer.....	5
Packing List.....	5
Appearance and Panel.....	6
Preparatory Work before Use:.....	8
Routine Maintenance.....	8
Precautions for Connection of Loads:.....	9
Use in Serial Connection and Parallel Connection of the Product.....	10
Basic Functional Operation:.....	11

Copyright Information

The design of this product (including internal software) and its accessories is under the protection of relevant state laws. Any one infringing upon the relevant rights of our company will be subject to legal sanctions. So users shall use this product in compliance with relevant state laws.

Symbol Description

Thanks for using our products. Before using the product, please read this manual carefully and pay attention to the warnings and cautions in it.

	Danger of electric shock!
	Risk of personal injury!

Safety Precautions

Precautions for use

[Warning:] Use of the product not following the instructions in this manual might affect the function of the product and even cause personal injury;

- Before use of the product, users should equip themselves with basic electric knowledge, fully understand the contents of the manual, as well as ensure personal safety. If the operator is not equipped with relevant electrical knowledge, personal injury might be caused, so please use the product under the supervision and guidance of the person who has a good command of electric knowledge.
- Please use the product for specified purposes. The product can only be used in industrial production environment.
- When the product is connected to the power supply, please use the attached power line. This product belongs to IEC over-voltage class-II standard instrument (the equipment that obtains energy from fixed equipment).
- Please be sure to use the power supply within the rated input power voltage range.
- When replacing the fuse, please replace it with the fuse that matches this product's specification and performance. For details, please refer to corresponding pages of the manual.
- The internal parts of instrument might threaten personal safety. So please don't dismantle the shell without permission.
- This product belongs to IEC standard Safety Class-I instrument (the instrument which is grounded and equipped with the protective conductor port). To prevent electric shock, please be sure to connect the protection port of the product to the grounding wire which meets the requirements of technical standard D of electrical equipment.
- In the event of product fault or exception, please stop using it immediately, and disconnect the external input circuit of power supply. Don't use the product being repaired.
- Please reserve enough space in the wiring process of the power supply.
- Please don't dismantle and modify the product without permission. If you need to modify it, please contact our dealer or our company.

Precautions for Routine Maintenance

- To guarantee continuous and high-performance operation of the product, it is advised to maintain and inspect the product regularly.
- To prevent electric shock, please be sure to unplug the plug or disconnect the power input circuit before maintenance and inspection.
- Please check regularly whether the outer layer of power line is damaged.
- When cleaning the display screen surface, wipe it gently with soft cloth soaked with clean water.
- The product has been strictly calibrated before delivery. To guarantee the performance of product, it is advised to calibrate it regularly. The product should be calibrated by the dealer or relevant personnel of our company.
- If the product needs to be modified or adjusted, it shall be performed by our company's technicians.
- Please don't tear up the warning labels attached on the outside of the product.

Precautions for Product Installation

- Don't use the product in flammable environment.
- Don't expose the product to high temperature or direct sunlight; please don't install the product near the heat generating equipment and heating equipment, and the places where the temperature change is drastic.
- Please don't install the product near the high-humidity places such as the water heater, humidifier, etc.

Overall Dimension Drawing

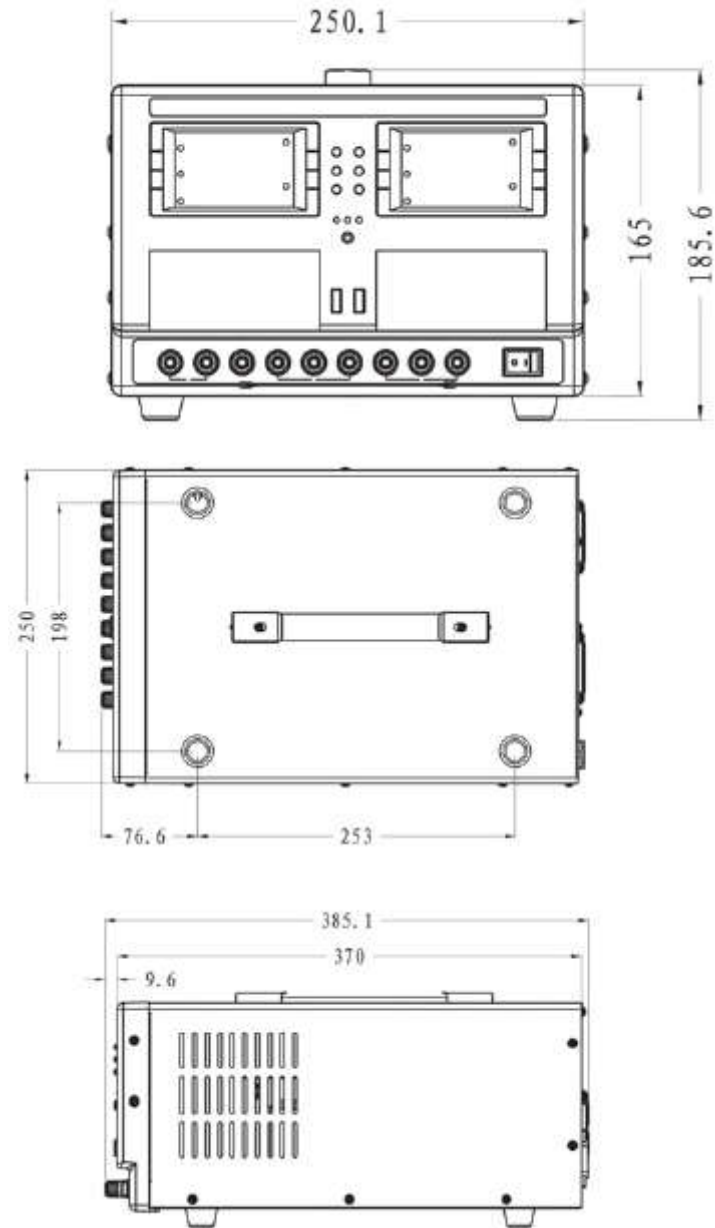

Technical Specification of PR Series:

Model	PR35-3A-3C			PR35-5A-3C		
Output specification	Channel 1	Channel 2	Channel 3	Channel 1	Channel 2	Channel 3
Rated output power	105W	105W	5W	175W	175W	5W
	215W			355W		
Voltage						
Rated output voltage	0~35V	5V (Fixed)		0~35V	5V (Fixed)	
Maximum preset voltage	105% of rating (V)	-		105% of rating (V)	-	
Setting resolution	1mV	-		1mV	-	
Setting accuracy	0.2% set + 0.1% rating	-		0.2% set + 0.1% rating	-	
Display accuracy	±(0.5% of rating + 2 digits)	-		±(0.5% of rating + 2 digits)	-	
Line regulation	3mV	-		4mV	-	
Load regulation	10mV	-		10mV	-	
Transient response	50us	-		50us	-	
Ripple noise	0.5mVrms	-		0.5mVrms	-	
Current						
Rated output current	0~3A	1A		0~5A	1A	
Maximum preset current	105% of rating (A)	-		105% of rating (A)	-	
Setting resolution	0.1mA	-		0.1mA	-	
Setting accuracy	0.3% set + 0.1% rating	-		0.3% set + 0.1% rating	-	
Display accuracy	±(1% of rating + 5 digits)	-		±(1% of rating + 5 digits)	-	
Line regulation	5mA	-		5mA	-	
Load regulation	5mA	-		5mA	-	
Ripple noise	1mArms	-		2mArms	-	
Temperature coefficient	200ppm/°C (typ)					
Protection function	Over-voltage / Over-current / Over-temperature protection					
Load regulation	Serial connection	≤300mV	-	≤300mV	-	
	Parallel connection	≤200mV	-	≤200mV	-	
Input voltage	220V±10%, 47-63Hz (100V, 117V, 200V, 217V or 234V)					
Operating temperature	0°C to +40°C					
Operating humidity	<85% RH					
Weight	12.8KG/PCS			14.6KG/PCS		
Dimension (W×H×D)	250×186×385mm					

- The product might be condensed within the operating temperature range. In such case, please don't use the product before it is completely dry.
- As the product is designed and manufactured for indoor use, please be sure to use it indoors.
- Please don't put the product in corrosive environment such as the environment heavy with sulfuric acid. Otherwise, it will lead to corrosion of internal conductor of the product or poor contact of connector, and cause fault or fire to the machine.
- Please don't put the product in dusty place.
- Please don't put the product in the place of poor ventilation, and ensure the surroundings of the product are well ventilated during the use.
- Please don't put the product on any object, and don't put the product on declining surface or in vibrating place.
- Please don't use the product in the places where there is strong magnetic field and strong electric field in the surroundings or the places where the waveform of input power supply is seriously distorted and the noise is severe.

Precautions for Movement of Product

- Please disconnect the power input circuit before moving the product.
- Please dismantle all connecting wires of the product.
- Please use safe packaging materials in transit.
- Please attach the Manual.

Disclaimer

We will take no responsibility for the personal injury or property damage caused in the process of this product due to the user's failure to operate according to related instructions, natural disaster and other force majeure or personal behavior rather than poor quality of product.

This manual is elaborately organized, compiled and released by SHENZHEN ATTEN TECHNOLOGY CO., LTD. according to the latest characteristics of product. Please contact us if you have any question or find any mistake. Besides, the Manual will be subject to changes in the subsequent improvement of the product and this Manual without prior notice. .

[Note:] To avoid damaging the machine and keep the operating environment safe, please read the Operation Manual carefully before use, and keep it properly for future reference.

Packing List

Power supply host	One unit
AC Cord	One PCS
User's Manual	One PCS

Appearance and Panel

Preview of front panel and introduction to operating keys on the panel

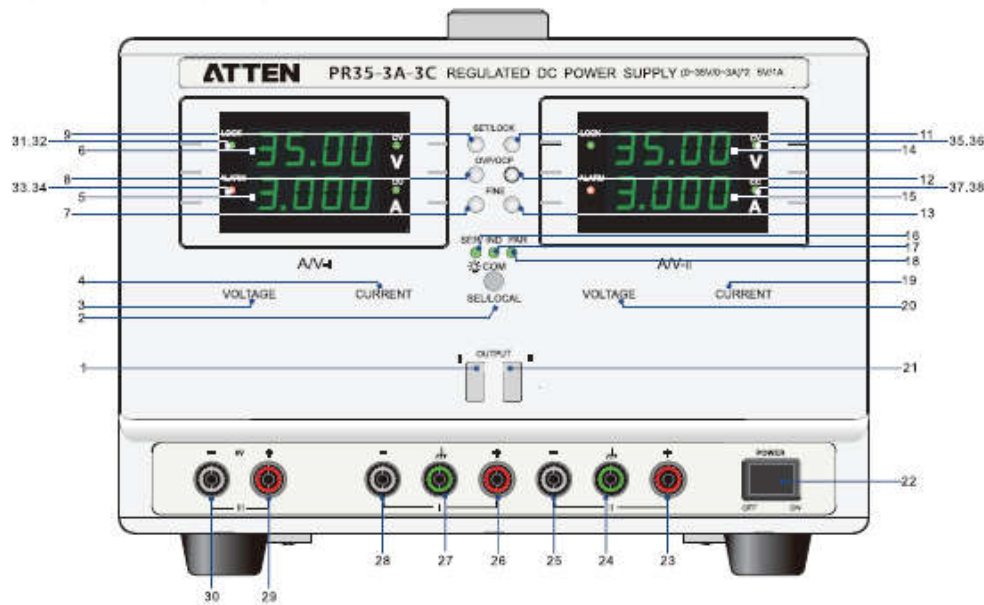

Introduction to the functions of keys on front panel:

No.	Part Name	Function Description
1, 21	OUTPUT	Output ON/FF
7, 13	FINE	Fine adjustment (press this key to turn the current and voltage rotary knob to realize fine adjustment)
8, 12	OVP/OCF	Set the over-voltage protection and over-current protection value.
9, 11	SET/LOCK	Set and confirm / key lock (built-in LED lamp)
6, 14	Voltage display	Display of voltage value / alarm
5, 15	Current display	Display of current value / reasons for alarm

Turn the VOLTAGE rotary knob to select the item, and set the power output to ON; turn the CURRENT rotary knob, and set the output current to 100% of the rated current according to the reading value of ammeter.

Offset of Ammeter:

1. Turn the VOLTAGE rotary knob to select the item, and set the power output to ON.
2. Press OVP · OCP key.
3. Confirm the displayed value of current, at the same time, turn the CURRENT rotary knob, and adjust the displayed value of PL current to the reading value of ammeter.

Full Range of Ammeter:

1. Turn the VOLTAGE rotary knob to select the item, and set the power output to ON.
2. Press OVP · OCP key.
3. Confirm the displayed value of current, at the same time, turn the CURRENT rotary knob, and adjust the displayed value of PL current to the reading value of ammeter.

Over-Current Protection

1. Turn the VOLTAGE rotary knob to select the item, and set the power output to ON.
2. Press OVP · OCP key to calibrate automatically.
3. After automatic calibration is finished, turn the VOLTAGE rotary knob to calibrate next item or press SET key to save it and exit.

Offset of output voltage	SU-b
▼	
Full range of output voltage	SU-b
▼	
Offset of output current	SC-b
▼	
Full range of output current	SC-b
▼	
Offset of voltmeter	dU-b
▼	
Full range of voltmeter	dU-b
▼	
Offset of ammeter	dC-b
▼	
Full range of ammeter	dC-b
▼	
Over-voltage protection (OVP)	□UPC
▼	
Over-current protection (OCP)	□CPC

Calibration of Voltage Parameters

Preparation: Put the product switch in OFF position, and connect the voltmeter to the output port.

Offset of Output Voltage:

Turn the VOLTAGE rotary knob to select the item, and set the power output to ON; turn the CURRENT rotary knob, and set the output voltage to 1% of the rated voltage according to the reading value of voltmeter.

Full Range of Output Voltage:

Turn the VOLTAGE rotary knob to select the item, and set the power output to ON; turn the CURRENT rotary knob, and set the output voltage to 100% of the rated voltage according to the reading value of voltmeter.

Offset of Voltmeter:

1. Turn the VOLTAGE rotary knob to select the item, and set the power output to ON.
2. Press OVP · OCP key.
3. Confirm the displayed value of voltage, at the same time, turn the CURRENT rotary knob, and adjust the displayed value of PL voltage to the reading value of voltmeter.

Full Range of Voltmeter:

1. Turn the VOLTAGE rotary knob to select the item, and set the power output to ON.
2. Press OVP · OCP key.
3. Confirm the displayed value of voltage, at the same time, turn the CURRENT rotary knob, and adjust the displayed value of PL voltage to the reading value of voltmeter.

Full Range of Over-voltage

1. Turn the VOLTAGE rotary knob to select the item, and set the power output to ON.
2. Press OVP · OCP key to calibrate automatically.
3. After automatic calibration is finished, turn the VOLTAGE rotary knob to calibrate next item or press SET key to save it and exit.

Calibration of Current Parameters

Preparation: Put the product switch in OFF position, and connect the shunt resistor to the output port.

Offset of Output Current:

Turn the VOLTAGE rotary knob to select the item, and set the power output to ON; turn the CURRENT rotary knob, and set the output current to 1% of the rated current according to the reading value of ammeter.

Full Range of Output Current:

3, 20	VOLTAGE	Setting of voltage value
4, 19	CURRENT	Setting of current value
31, 32	LOCK	Indication of locked state
33, 34	ALARM	Indication of alarm state
35, 36	CV	Indication of constant-voltage state
37, 38	CC	Indication of constant-current state
28, 25	-	Negative end of output
27, 24	⏏	Ground
26, 23	+	Positive end of output
22	POWER	Power switch
16, 17, 18	SER\IND\PAR	Indication of serial connection, independent, and parallel connection state
2	SEL	Indication of serial connection, parallel connection, and independent state
30	Negative end of three-way output	
29		

Preview of Rear Panel and Introduction to Each Part

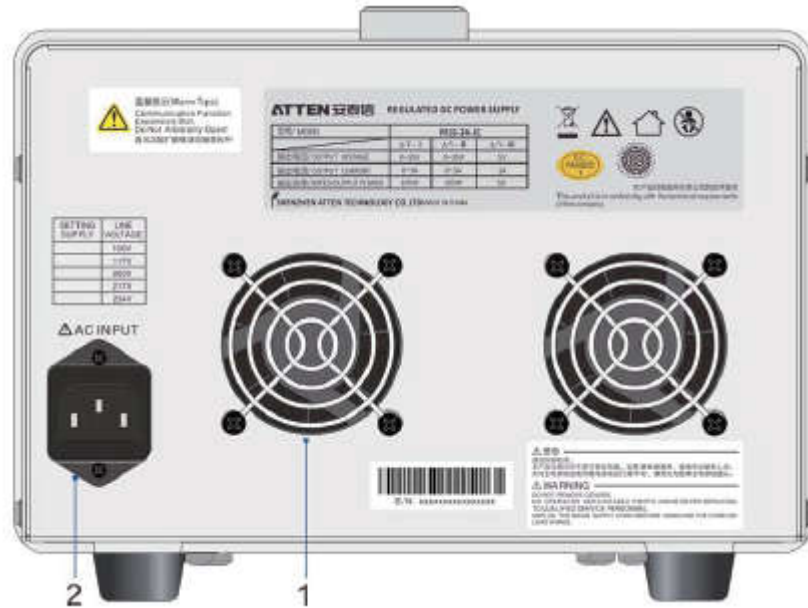

No.	Part Name	Function
1	Vent	Vent (used for cooling)
2	Input power line interface	AC input interface

Preparatory Work before Use:

Precautions for Connection of Power Line

[Warning:] This product belongs to IEC over-voltage class-II standard instrument (the energy-consuming instrument that obtains energy from fixed equipment), so beware of electric shock.

[Warning:] This product belongs to IEC standard Safety Class-I instrument, and is equipped with protective conductor. To prevent electric shock, be sure that the machine is grounded.

- If the power line in the accessories cannot be used due to its shape or other reasons, please contact the dealer or ATEN to obtain appropriate power line.
- Please don't use the attached power line of this instrument on other products.

Steps for Connection of Power Line

1. Confirm whether the connected power line is suitable for the rated input of the product;
2. Confirm the power switch is in OFF state;
3. Confirm the external input power line has been connected to AC input port on rear panel;
4. Connect the plug of power line to the power supply circuit;

- Alarm. The alarm operation in parallel connection state is consistent with the operation and use of single-way alarm.

Connection for Use in Serial Connection

[Note:]

- To prevent vibration, the load end should be connected to the electrolytic capacitor with hundreds of μF ~ tens of thousands of μF as required. The longer the wire is, the easier it is to generate vibration due to the phase shift caused by the electrical inductance and capacitance of wire. Please use the electrolytic capacitor with the withstand voltage exceeding 120% of the rated output voltage.

Connection steps are as follows:



1. Confirm that the power output of two ways is in closed state, and these two ways are not in voltage and current setting state and OVP/OCP setting state;
2. Confirm the output state of power supply; (whether it is in serial connection mode)
3. Connect the power output end to the load; (connect the positive pole of load to the positive end of Way-II output, and connect its negative pole to the negative end of Way-I output)
4. Set the over-voltage / over-current protection value, and OVP / OCP value;
5. Press any key to exit. (the output key of either Way I or Way II)

Routine Maintenance

Preparation for Calibration

The following parameters can be calibrated:

Offset of output voltage	Full range of output voltage
Offset of voltmeter	Full range of voltmeter
Offset of output current	Full range of output current
Offset of ammeter	Full range of ammeter
Over-voltage protection	Over-current protection

Devices required by calibration: DC voltmeter with the measurement precision over 0.02%; shunt resistor or voltmeter with the precision of 0.1%;

Calibration environment: Temperature: $23^{\circ}\text{C} \pm 5^{\circ}\text{C}$; humidity: below 80% rh; to reduce calibration error, please electrify to warm up the product 30min before calibration, similarly, the calibration tools also need to be warmed up for some time.

Calibration Steps

Press and hold (not release) FINE key and OVP/OCP key, and put the power switch in ON position;

Turn the VOLTAGE rotary knob, and select the calibration item;

Press SET key to save the setting content.

The switching sequence of calibration mode is as follows:

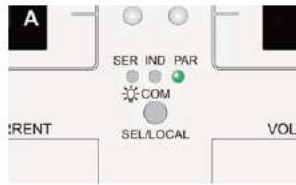

Parallel connection function is described below:

- Voltage / Current display, with the left way as the main way. The voltage displayed by Way I is the output voltage value in parallel connection state, and the current displayed by Way I is the output current value in parallel connection state. Way II displays the parallel connection state.
- Alarm. The alarm operation in parallel connection state is consistent with the operation and use of single-way alarm.

Connection for Use in Parallel Connection

[Note:]

- When connecting the output end, the positive end is connected to the positive end of Way II (23 as shown in the figure below), and the negative end is connected to the negative end of Way I (28 as shown in the figure below).
- To prevent vibration, the load end should be connected to the electrolytic capacitor with hundreds of μF ~ tens of thousands of μF as required. The longer the wire is, the easier it is to generate vibration due to the phase shift caused by the electrical inductance and capacitance of wire. Please use the electrolytic capacitor with the withstand voltage exceeding 120% of the rated output voltage.

Connection steps are as follows:

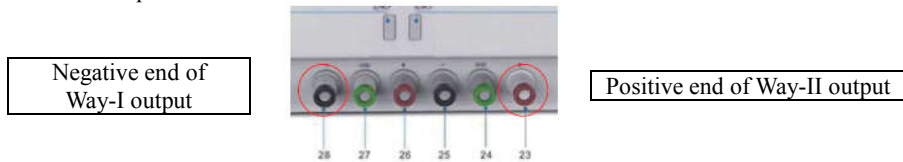

1. Confirm that the power output of two ways is in closed state, and these two ways are not in voltage and current setting state and OVP/OCV setting state;
2. Confirm the output state of power supply; (whether it is in parallel connection mode)
3. Connect the power output end to the load; (connect the positive pole of load to the positive end of Way-II output, and connect its negative pole to the negative end of Way-I output)
4. Set the over-voltage / over-current protection value, and OVP / OCP value;
5. Press any key to exit. (the output key of either Way I or Way II)

Use in Serial Connection

The user may connect two ways of the product in serial to increase the voltage capacity. During the use in serial connection, the voltage of the load is the total output voltage of two-way power supply. During the use in parallel connection, press the serial and parallel connection conversion key SEL to light the SER indicator lamp (as shown in the figure below).

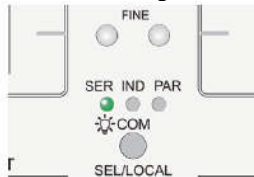

Parallel connection function is described below:

- Voltage / Current display, with the left way as the main way. The voltage displayed by Way I is the output voltage value in serial connection state, and the current displayed by Way I is the output current value in serial connection state; Way II displays the serial connection state.

Turn on the Power Switch

[Note:]

- Through the system settings, the user can set the operating parameters of the machine after the power switch is turned on. If the user sets the output of system startup to ON, but doesn't set correct OVP and OCP value, the load might be damaged when the machine switch is turned on.
- When the user uses the machine at the first time, after the power switch is turned on, the machine will be started according to the factory settings. After the machine is used for the second time, it will be started according to previous settings.

Steps for Turning on the Machine Switch and Machine Output

1. Confirm whether the power line is connected correctly;
 2. Put the machine switch in ON (I) position;
- After all LEDs are lit on once, the voltage display unit and current display area will, at an interval of 1sec, display: the rated voltage and rated current - firmware version (IOC) – firmware version (IFC). After all the above contents are displayed, the machine will enter the state of waiting for operation (the output value is displayed).



Display of rated voltage and rated current

Display of software version number

※ The above is diagram, and the real object will prevail.

[Note:] When turning on the power switch, it will generate impulse current, and particularly when several machines are used, if the power switches are set to ON at the same time, please pay attention to the power supply circuit.

Turn off the Machine Switch

Put the machine switch in OFF (O) position;
The product can save various parameter settings (except ON/OFF state of OUTPUT) of the machine before the system is shut down, but some set parameters cannot be saved.

[Note:] Please don't frequently switch ON/OFF state of switch; otherwise, the machine might be damaged easily; ensure the time interval of switching is greater than 10sec;

Precautions for Connection of Loads:

When connecting the following loads, output instability might occur, so please pay attention to:

The loads that the peak and pulse current passes through.

The voltage and current value displayed by the product is average value. The measured value of current displayed on the panel might be less than the set value, and the actual peak current is greater than the set value. In such case, the product will make instantaneous constant current action and the output voltage will become small.

For such type of load, it is required to increase the set value of constant current, or increase the capacitance.

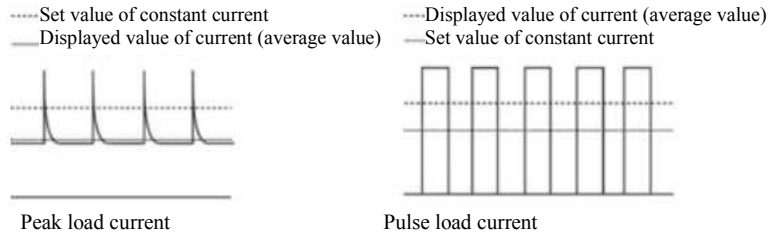

Load which generates reverse current to power supply

This product could not absorb the reverse current from the load. When the product is connected to the load which might generate reverse current (inverter, converter, transformer, etc), the output will become unstable and cause fault. For such type of load, as shown in the figure below, connect the product to the resistor (R_D), shunt the reverse current, but the current which flows to the load will decrease by I_{rp} .

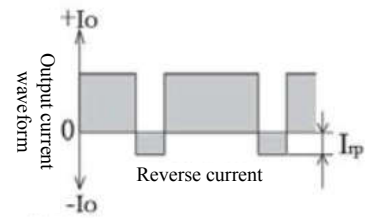
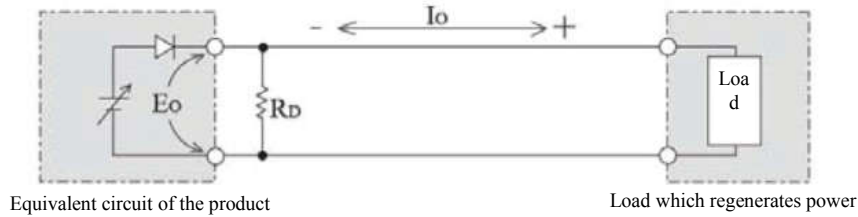

$$R_D[\Omega] \approx \frac{E_0[V]}{I_{rp}[A]}$$

R_D : Dummy load for use in parallel connection of reverse current
 E_0 : Output voltage
 I_{rp} : Maximum reverse current

[Note:] Please select the resistor R_D with enough rated power, and if the rated power of resistor in the circuit is not high enough, R_D might be burnt down.

Load with stored energy

When connecting to the load with energy storage effect, the current might flow from the load to the internal circuit of the product, and it might damage the product or reduce the service life of the load. For such type of load, as shown in the figure below, connect the product in series to a diode (in the position of D_{rp}) to prevent reverse current between the product and load.

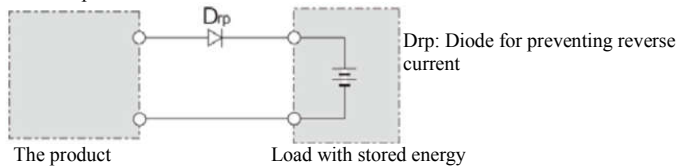

[Note:]

- To protect the product and load, please use D_{rp} which conforms to the following standards.
- Reverse voltage tolerance: Over twice the rated output voltage of the product.
- Forward current capacity: Three to ten times of the rated output current of the product.
- Please only use low-loss elements.
- As D_{rp} can generate heat, please ensure sufficient heat dissipation. If the heat dissipation effect is not good, D_{rp} might be burnt down.

1. Confirm that correct OVP/COP trigger value has been set;
2. Confirm the power output is in opened state;
3. Rotate OVLTAJE / CURRENT rotary knob to the right to increase the output voltage to the OVP/OCOP trigger value; if there is no fault with the machine, it will: close the output, the ALARM LED will be on, and the fault reason will be displayed on the display screen.
4. Close the power output.
5. Turn off the power switch.

Over-temperature Protection

When the internal temperature increases abnormally, the over-temperature protection of the machine will be triggered. The over-temperature protection may be triggered for the following reasons:

- The ambient temperature exceeds the maximum operating temperature of the machine (+40°C);
- The air suction port and vent are blocked;
- The exhaust fan stops working;

[Note:]

If the power switch is turned on while the cause of over-temperature protection is not eliminated, the machine will enter the over-temperature protection again;

Otherwise, they will be replaced by the preset voltage and current.

Panel Locking and Unlocking



To prevent user's faulty operation, the machine provides the function of locking the operation panel. The user can lock the panel by means of: pressing and holding the FINE+LOCK key (first pressing FINE key) until the lamp is on, which means the machine has been in locked state. The user can unlock the machine by means of: pressing and holding FINE+LOCK key (first pressing FINE key) until the lamp is off, which means the machine has exited the locked state.

List of Initial Settings of the System

	Set Item	Set Value
Common parameters	Output voltage	0V
	Output current	105% of rated output current
	OVP (over-voltage protection)	110% of rated output voltage
	OCP (over-current protection)	110% of rated output current +1.5A

Use in Serial Connection and Parallel Connection of the Product

Use in Parallel Connection

The user may use this product in parallel connection to increase the current capacity. When using the power supply in parallel connection, press the serial and parallel connection conversion key SEL to light on the PAR indicator lamp (as shown below).

Constant-voltage / Constant-current operation steps:

1. Put POWER switch in OFF position.
 2. Connect the load to the output end;
 3. Turn on the power switch;
 4. Press OUTPUT key to open or close the output;
 5. Press SET key, and the set value will be displayed;
 6. Rotate VOLTAGE/CURRENT rotary knob to set the output; the adjustment range of voltage is: 0~105%* rated voltage; adjustment range of current: 0~103% of rated current;
- When the machine is working in the working mode of constant-voltage output, CV LED lamp will be on; when the machine is working in the working mode of constant-current output, CC LED lamp will be on.



OHP is on
The alarm is displayed

Related Operations of Protection Function and Alarm

After entering the protection (the machine provides OVP, OCP, and OHP three protection functions) state, the machine will: close the output, ALARM LED lamp will be on, the display screen will display the causes of fault, and the alarm signal will be outputted from No. 13 pin connected to J1;

Release of Alarm:

After the alarm reason is eliminated, press FINE + SET key or turn off the power switch and then turn it on. If the alarm cannot be removed after the user has eliminated the alarm reason, there might be fault with the machine. Please contact ATTEN or our dealer in time.

Setting of Over-voltage Protection / Over-current Protection

The over-voltage protection (OVP) is a protection mechanism for preventing generating too high output voltage and thus damaging the load.

The over-current protection (OCP) is a protection mechanism for preventing generating too high output current and thus damaging the load.

When connecting the load, the user should set correct OVP/OCP value; the user can set OCP/OCP trigger value through the following operation.

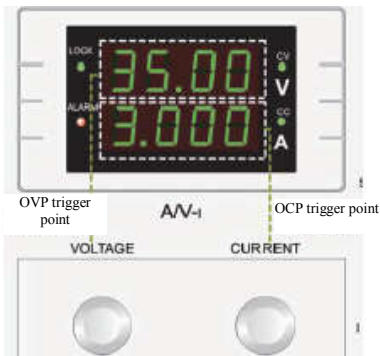

Confirmation of Over-voltage Protection / Over-current Protection

1. When the power supply is normal (the output is closed), press OVP ·OCP key, and the display screen will display the previously set OVP / OCP trigger value.
2. Rotate VOLTAGE rotary knob or CURRENT rotary knob to change the OVP and OCP trigger value respectively. When pressing and holding FINE key, rotate the VOLTAGE / CURRENT rotary knob to adjust the parameters finely.
3. OVP setting range: 10%~110% of rated output voltage; OCP setting range: 10% ~110% of rated output current;
4. Then press OVP ·OCP key again to exit the setting of OVP ·OCP trigger value;

Reverse current from external voltage source

When external voltage source is directly connected to the product, due to the reverse current generated by internal voltage divider circuit of the product, the product might be damaged, and the service life of load might be reduced.

For such type of reverse current, it is required to connect the diode for preventing reverse current to the load wire or use the switch or other element to disconnect the load wire from the product.

When the product is connected to the external voltage source, the reverse current may be different according to POWER OFF or OUTPUT OFF state.

The reverse current is small when the output voltage is small, and there is almost no reverse current near 0V.

[Warning:]

- Please use the wire with enough current capacity (meeting the requirements of rated output current of the product) to connect the load.
- As high temperature might be generated near the output end, the heat-resistance temperature of external insulating layer of the wire should be greater than 85°C.
- Beware of the danger of electric shock.
- Please use the wire with its rated voltage higher than the ground insulation voltage of the product to connect the load.

The permissible current of wire is related to the maximum allowable heat-resistance temperature of insulator.

The temperature of wire is subject to the electric heat temperature caused by the current. When the heat tolerance temperature of insulating layer of wire is low, the ambient temperature is greater than 30°C, the wires are bundled and the heat dissipation effect is poor, the capacity of output current should be lowered appropriately.

How to eliminate the noise

When arranging the wires with the same heat resistance temperature, the wires should be scattered as much as possible so as to radiate the heat and increase the flow of wire current. However, when the output line (anode) and output line (cathode) are close to each other or the wires are arranged in bundles, it will facilitate elimination of noise.

[Warning:]

- Beware of the danger of electric shock.
- When touching the output port, put POWER in OFF position.

Connecting steps:

1. Please put POWER in OFF position.
2. Connect the crimping terminal to the load wire.
3. Connect the load wire to the output port.
4. Install (Tighten) the rotary knob on output port cover.

The output port diagram of the machine:



Basic Functional Operation:

Display of Measured Value and Set Value

For display of the current and voltage, there are two types of values: measured value and set value; the current and voltage display area can display the system parameters in addition to the voltage and current.

Display of measured value:



Display the current output voltage and output current. In such state, the LED lamp of SET key is off. Even when the measured value is displayed, it is also allowed to change the setting of output voltage and output current.

Display of set value:



Press SET key, the LED (SET) lamp will be lit on, and the current set value of output voltage and current will be displayed. Press SET key once again, and it will display the measured value. When recalling the preset value, the panel will display the preset value.

Display of set value of over-voltage / over-current protection:



Press OCP · OVP key, and the LED (OCP · OVP) lamp will be on and display the current over-current and over-voltage protection trigger value.

Adjustment of parameters



Rotate the voltage rotary knob, and the voltage value can be changed; rotate the current rotary knob, and the current value can be changed. The values can be changed regardless of the set state (ON/OFF) of OUTPUT (output).

Fine adjustment:

The user can make fine adjustment by pressing and holding (not releasing) FINE key and then rotating the voltage rotary knob or current rotary knob; in the fine adjustment, the displayed value might not change, which is because the adjustment value doesn't achieve the minimum precision of display; the table below shows the change value for each step of fine adjustment:

OUTPUT is ON.	Change on the basis of 1/10 of the minimum digit of displayed value of voltage and current.
OUTPUT is OFF.	Change on the basis of one digit of the minimum digit of displayed value of voltage and current.

Output ON/OFF

The user can press OUTPUT key to switch to output. When output is opened, LED (OUTPUT) lamp will be on; when output is closed, LED (OUTPUT) lamp will be off, as shown in the figure below:

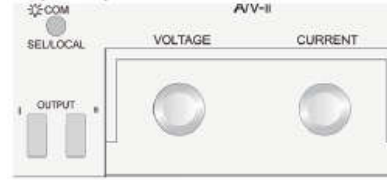

[Note:] In system configuration, the output state of the machine when turning on the switch can be changed; if the output state of the machine when turning on the switch is set to ON, the user must pay attention to the set value of OVP · OCP, to prevent causing too high output voltage and thus damaging the load;

Constant-voltage and Constant-current Operation

The product can work in constant-voltage and constant-current mode, and even if the load changes, the output voltage and current can remain unchanged. The switching of constant-voltage and constant-current mode is determined by: the set value of output voltage, the set value of output current, and the load resistance.

The following describes the above working principle.

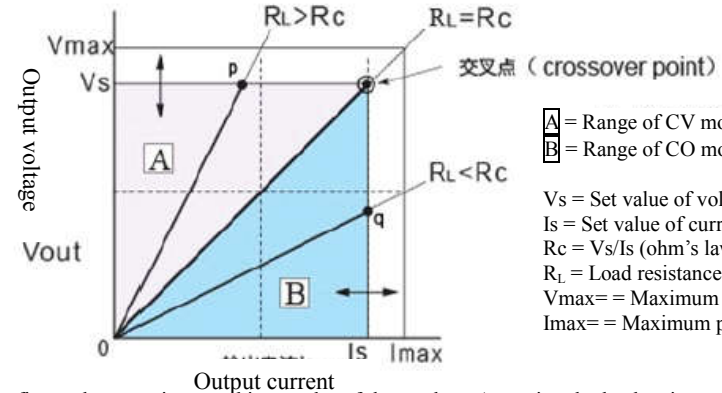

The above figure shows various working modes of the product. Assuming the load resistance is R_L , we can calculate the resistance value R_c ($R_c = V_s/I_s$). Take the line of $R_L = R_c$ as the boundary, in Part A (in which R_L is greater than R_c), the machine will be working in constant-voltage mode, and in Part B (in which R_L is less than R_c), the machine will be working in constant-current mode. The line of $R_L = R_c$ means the load for which the output voltage of the load is equal to the set voltage, and the output current is equal to the set current. When R_L is equal to R_c , the machine will switch between constant-voltage and constant-current mode automatically, and we regard the point of $R_L = R_c$ as the crossover point;

Calculation example in constant-current and constant-voltage mode:

Assuming the current load resistance $R_L = 80\Omega$, and the output voltage and current are set to 30V and 0.5A respectively, then $R_c = V_s/I_s = 30/0.5 = 60\Omega$, and since R_L is greater than R_c , the machine is working in constant-voltage mode, and the maximum voltage in constant-voltage mode is $V_s = I_s * R_L = 40V$, therefore, the maximum voltage in constant-voltage mode is 40V. Boost the voltage and when it exceeds 40V, and achieves the crossover point, the machine will automatically switch to the constant-current mode. To maintain the constant-voltage mode, please increase the set value of output current.

Assuming the current load resistance R_L is 40Ω, and the output voltage and current are set to 30V and 0.5A respectively, then $R_c = V_s/I_s = 30/0.5 = 60\Omega$, and since R_L is less than R_c , the machine is working in constant-current mode, and the maximum current in constant-voltage mode is $I_s = V_s/R_L = 0.75$, therefore, the maximum current in constant-voltage mode is 0.75. Boost the current and when it exceeds 0.75A, and achieves the crossover point, the machine will automatically switch to the constant-voltage mode. To maintain the constant-current mode, please increase the value of output voltage.