



TYPE SELECTING MANUAL OF PRODUCT

# HAO QUAN PUMPS INDUSTRY

MP SERIES MAGNETIC CIRCULATING PUMP  
DZ/DS SERIES BELLOWS METERING PUMP  
DP SERIES HIGH PRESSURE DIAPHRAGM PUMP

Thailand Distributor :

Energy Power Save CO.,LTD  
442/2 Chan Road, Thung Watdon Sathon Bangkok Thailand 10120  
Office Tel : +66 (02) 114 7145-9 Ext. Sales. Email : info@7-mars.com

**WENZHOU HAOQUAN PUMPS CO.,LTD.**

Honesty. Pragmatic management. Innovation excellence



## Company Profile

Wenzhou Hao Quan pump industrial Co., Ltd. Is a collection research and development, production and sales of manufacturing enterprise. The company is located in Dongcheng industrial Park Longgang Wenzhou City, superior geographical location, convenient transportation.

Company is with advanced technology and years of practical experience combined, "To forge ahead and strive for perfection" is as the spirit, technology road, to develop high-quality, high technical staffs, to produce high quality products, sincerely provide to our customers! The company always takes the quality as the enterprise life viewpoint, has the advanced quality inspection system, the consummation pre-sale and after sales service, according to the quality management system develop steadily. The products are widely used in various fields, chemical industry, medicine, construction, environmental protection, water conservancy, electricity, oil, fire protection, food, color printing and etc., favored by users!

"Quality, brand, reputation" is our eternal pursuits, customer satisfaction is our aim! The company will always adhere to the customer-oriented, to meet the needs of market development and changes, to sincerely cooperate with numerous friends, to achieve mutual benefit and win-win.

The era is moving forward, "Hao Quan" is soaring up, we always welcome you. Welcome friends from all walks of life come to visit, guidance and business negotiation.



## Pump---MP Series Products



MP-6R



MP-10RM



MP-10RN



MP-15R



MP-15RM



MP-15RN



MP-20R



MP-20RM



MP-20RX



MP-20RZ



MP-20RZM



MP-30R



MP-30RM



MP-30RX



MP-30RXM



MP-30RZ



MP-30RZM



MP-40R



MP-40RM



MP-40RX



MP-40RXM



MP-55R



MP-55RM



MP-70R



MP-70RM



MP-100R



MP-100RM



MP-100RX



MP-120R



MPH-400



MPH-401



MPH-422



MPH-4223

## Construction of Pump

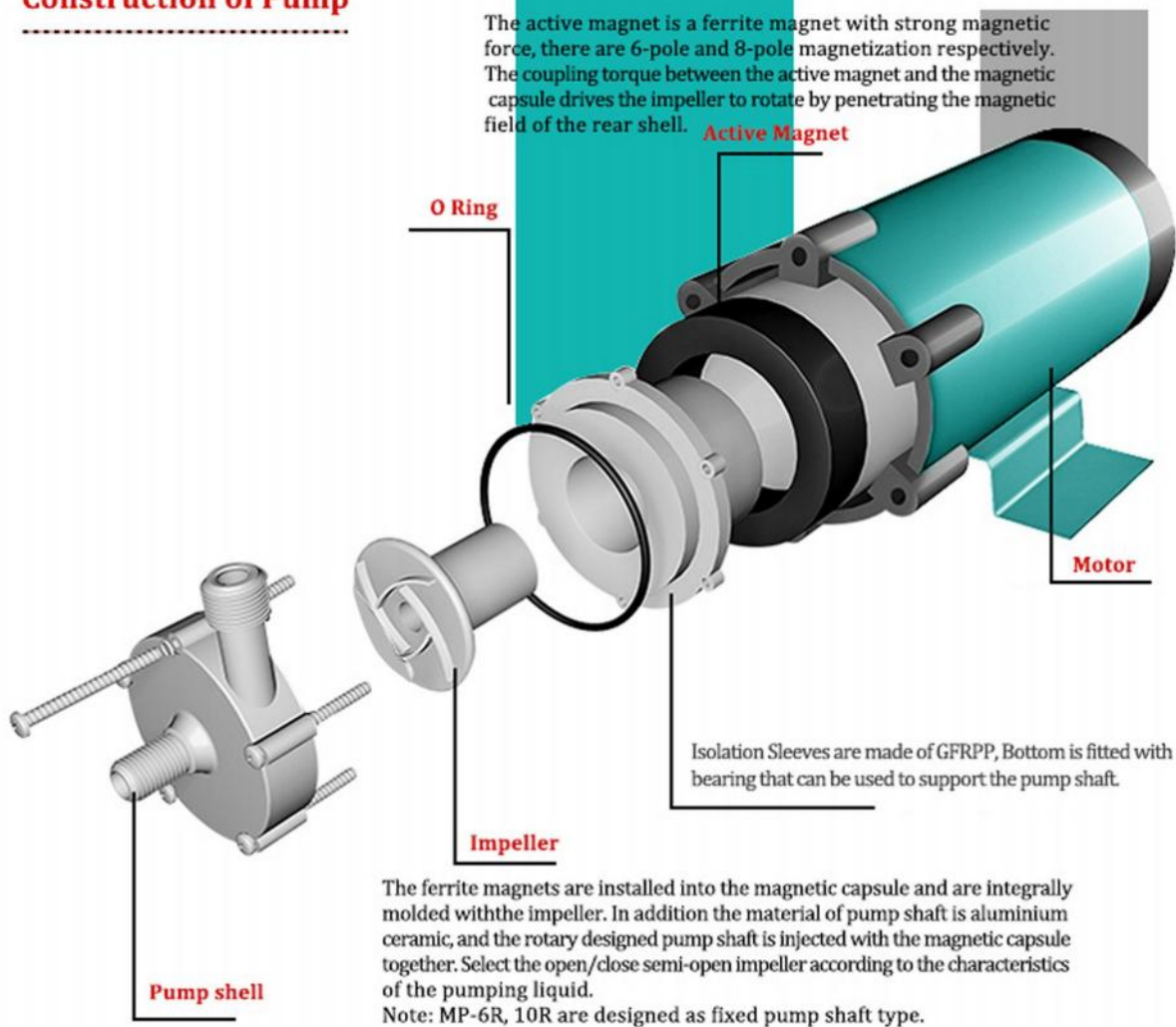

You can select the tube connection type or threaded connection types as per needs. And it is allowed to change threaded to union coupling type flexibly.

### Material

Stainless steel  
 Glass fiber reinforce polypropylene  
 Alumina ceramic  
 Sr ferrite  
 Fluoride rubber(FKM) or ternary ethylene propylene rubber (EPDM)



## Model Note

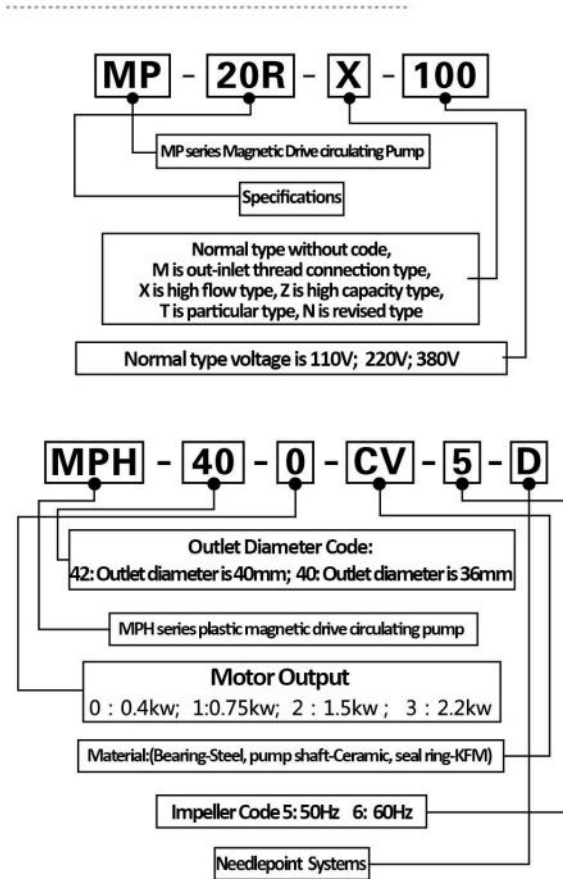

### Features of Magnetic Pump

Magnetic drive circulation pump is a full-sealed pump, for motor connecting shaft and impeller are separately equipped with magnetic materials, they attract each other and coupled. It's unnecessary to fit with traditional shaft seal. The rotation torsion of motor drives impeller to rotate through the attraction between driving magnet and driven magnet. The shortcoming of present customary magnetic drive pump is that rotation is absolutely prohibited under the condition of lacking liquid, otherwise, the machine will be destroyed, resulted in unnecessary troubles for customer. "HAOQUAN" adopts special ceramics as shaft bearing, characterizing strong resistance for abrasion and corrosion.

Magnetic drive circulation pump is generally designed for no shaft seal, completely avoids defects of pollution after corrosion caused by liquid leakage, which exists in traditional mechanical shaftscal pump. It is the optimum liquid transport pump on the industrial equipments.

## PUMP SPECIFICATIONS

Model	Tube interface		Thread interface		Max. Capacity (L/min)	Max. Head (m)	Standard capacity		Specific gravit	Motor	
	Inter (mm)	Outlet (mm)	Out-inlet (inch)	Tube (mm)	50Hz/60Hz	50Hz/60Hz	Capacity (L/min) 50Hz/60Hz	Head(m) 50Hz/60Hz		Output (w) 50Hz/60Hz	Phase
MP-6R	14	14	-	-	8/9	1/1.4	2.8/5	0.8	<1.2	6	1
MP-6RZ	14	14	-	-	5.5/6	2.1/2.7	3.2/4.5	0.8	<1.1	6	1
MP-10RN	14	14	-	-	11/12	1.5/2.1	5/8	1	<1.1	6	1
MP-10RM	-	-	1/2	1/2	11/12	1.5/2.1	5/8	1	<1.1	6	1
MP-15R	16	16	-	-	16/19	2.7/3.4	8/12	1.5	<1.3	10	1
MP-15RN	16	16	-	-	16/19	2.7/3.4	8/12	1.5	<1.3	10	1
MP-15RM	-	-	1/2	1/2	16/19	2.4/3.4	8/12	1.5	<1.3	10	1
MP-20R	18	18	-	-	27/32	3.1/4.3	17/22	2	<1.2	15	1
MP-20RM	-	-	1/2	1/2	27/32	3.1/4.3	17/22	2	<1.2	15	1
MP-20RX	26	26	-	-	46/52	1.8/2.5	30/40	1	<1.3	15	1
MP-2RZ	18	18	-	-	10/11	4.6/6.9	7/10	4	<1.1	15	1
MP-20RZM	-	-	3/4	3/4	10/11	4.6/6.9	7/10	4	<1.1	15	1
MP-30R	20	20	-	-	33/38	3.8/5.4	16/25	2.5	<1.3	25	1
MP-30RM	-	-	3/4	3/4	33/38	3.8/5.4	16/25	2.5	<1.3	25	1
MP-30RX	26	26	-	-	62/72	2.9/4.1	32/46	2	<1.1	25	1
MP-30RXM	-	-	1	1	62/72	2.9/4.1	32/46	2	<1.1	25	1
MP-30RZ	18	18	-	-	15/17	8/11	10/14	6	<1.1	25	1
MP-30RZM	-	-	3/4	3/4	15/17	8/11	10/14	6	<1.1	25	1
MP-40R	20	20	-	-	45/52	4.6/6.5	22/34	4	<1.1	65	1or3
MP-40RM	-	-	3/4	3/4	45/52	4.6/6.5	22/34	4	<1.1	65	1or3
MP-40RX	26	26	-	-	75/85	3.3/4.7	47/65	2	<1.1	65	1or3
MP-40RXM	-	-	1	1	75/85	3.3/4.7	47/65	2	<1.1	65	1or3
MP-40RZ	18	18	-	-	22/28	10/13.5	10	8	<1.1	65	1or3
MP-40RZM	-	-	3/4	3/4	22/28	10/13.5	10	8	<1.1	65	1or3



## PERFORMANCE CURVES

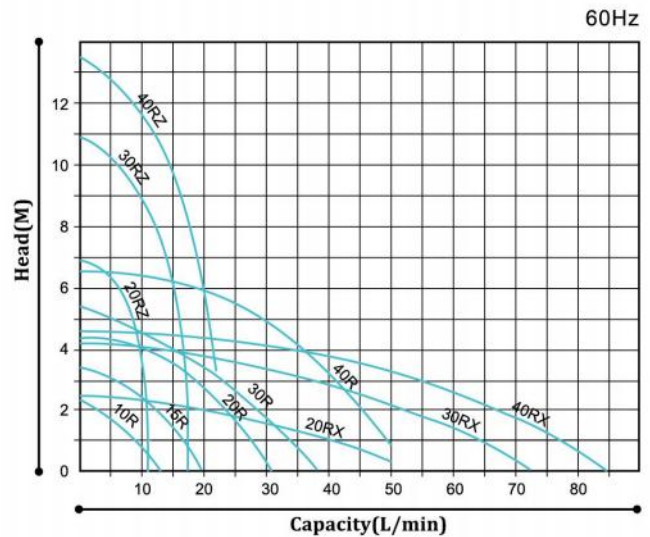
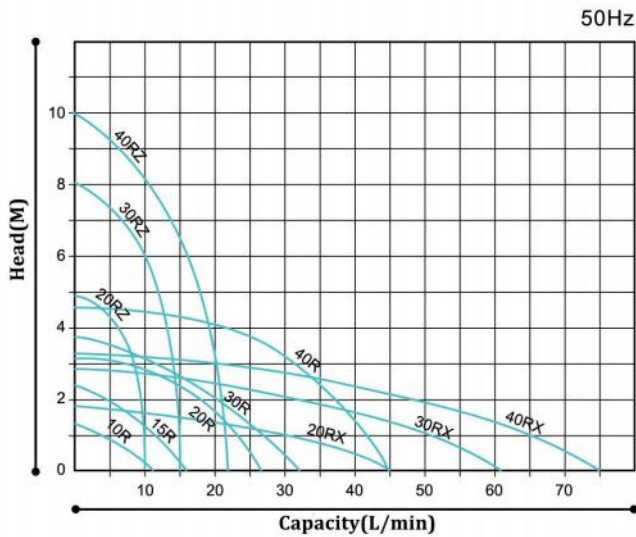

## DIMENSIONS

MP-6R-10R-15R-20R-30R-40R

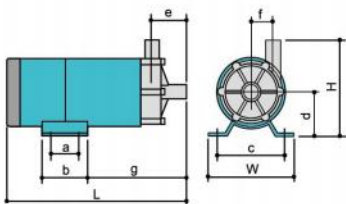

Model	W	H	L	a	b	c	d	e	f	g	i
MP-6R	74	83	129.5	-	30	60	37	31	17	60	2-φ5.4
MP-10R	74	83	129.5	-	30	60	37	31	17	60	2-φ5.4
MP-15R	82	101	197	49	63	68	48	38	23	88	4-φ6×9
MP-20R	86	115	209	30	50	69	56	39	29	107	4-φ5×8
MP-30R	120	130	250	40	64	100	60	48	31	135	4-φ9×12
MP-40R			274								

MP-20RZ-30RZ-40RZ

MP-20RX-30RX-40RX-100RX

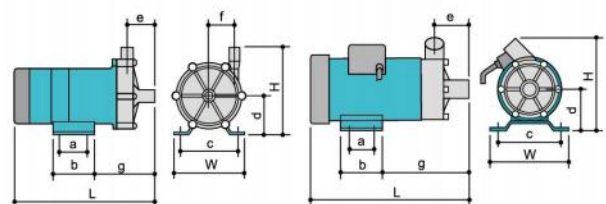

Model	W	H	L	a	b	c	d	e	f	g	i
MP-20RZ	86	125	211	30	59	69	55	40	39	108	4-5×8
MP-30RZ	120	130	234	40	64	100	60	39	45	128	4-φ9
MP-40RZ			241								
MP-20RX	86	130	220	30	59	69	56	47	-	105	4-5×8
MP-30RX	120	138	253	40	64	100	60	48	-	138	4-φ9
MP-40RX			276								
MP-100RX	156	174	323	70	100	110	74	63	-	196.5	4-9×27

## PRODUCT SPECIFICATIONS

Model	Tube interface		Thread interface		Max. Capacity (L/min)	Max. Head (m)	Standard capacity		Specific gravit	Motor	
	Inter (mm)	Outlet (mm)	Out-inlet (inch)	Tube (mm)	50Hz/60Hz	50Hz/60Hz	Capacity (L/min) 50Hz/60Hz	Head (m) 50Hz/60Hz		Output (w) 50Hz/60Hz	Phase
MP-55R	26	26	-	-	60/70	5.6/8.2	30/45	4	<1.2	90	1or3
MP-55RM	-	-	1	1	60/70	5.6/8.2	30/45	4	<1.2	90	1or3
MP-55RZ	26	26	-	-	25/28	10/14	15/22	8	<1.1	90	1or3
MP-55RZM	-	-	1	1	25/28	10/14	15/22	8	<1.1	90	1or3
MP-70R	26	26	-	-	86/97	6.7/9.7	50/72	4	<1.1	150/180	1or3
MP-70RM	-	-	1	1	86/97	6.7/9.7	50/72	4	<1.1	150/180	1or3
MP-70RZ	20	20	-	-	40/43	14.3/20.3	20/24	12	<1.1	150/180	1or3
MP-70RZM	-	-	3/4	3/4	40/43	14.3/20.3	20/24	12	<1.1	150/180	1or3
MP-100R	26	26	-	-	120/130	8.6/11.6	60/70	7/9	<1.3	250/265	1or3
MP-100RM	-	-	1	1	120/130	8.6/11.6	60/70	7/9	<1.3	250/265	1or3
MP-100RX	-	-	1 1/4	1 1/4	170	9.0	100	5.0	<1.3	250	1or3
MP-120R	-	-	1 1/2	1 1/2	220	10.5	140	6.0	<1.3	370	1or3
MPH-400	-	-	1 1/2	1 1/2	260	12.5	150	8.5	<1.3	400	3
MPH-401	50	50	1 1/2	1 1/2	330	18	200	12	<1.3	750	3
MPH-422	63	50	2	1 1/2	400	23	200	18	<1.3	1500	3
MPH-423	63	50	2	1 1/2	500	24	300	20	<1.3	2200	3
MPH-425	63	50	2	1 1/2	600	29	400	25	<1.3	3000	3

## PERFORMANCE CURVES

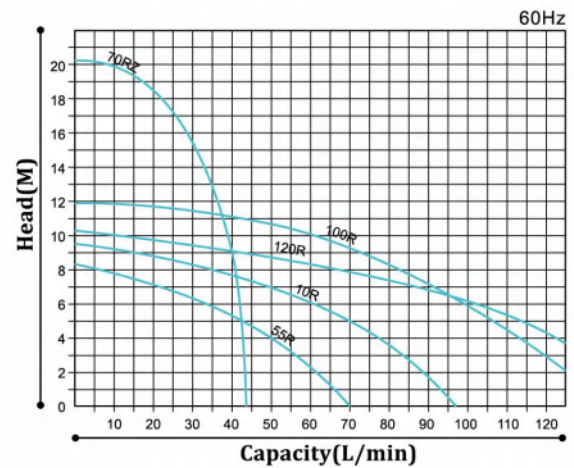
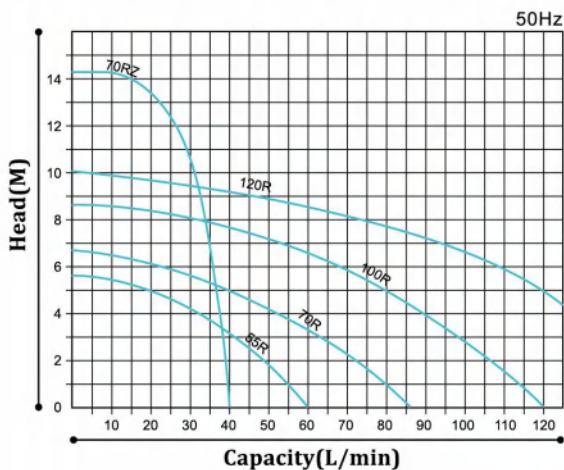





## PERFORMANCE CURVES

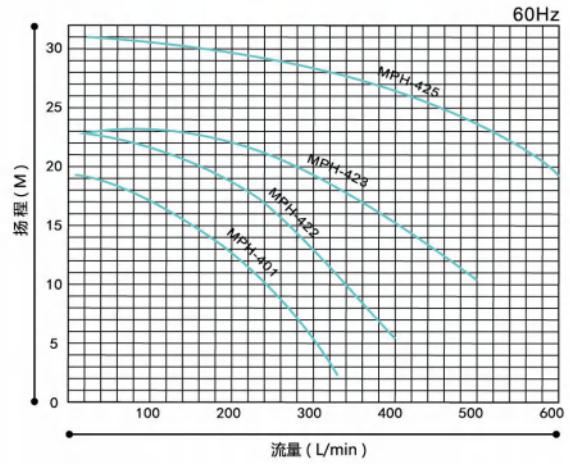
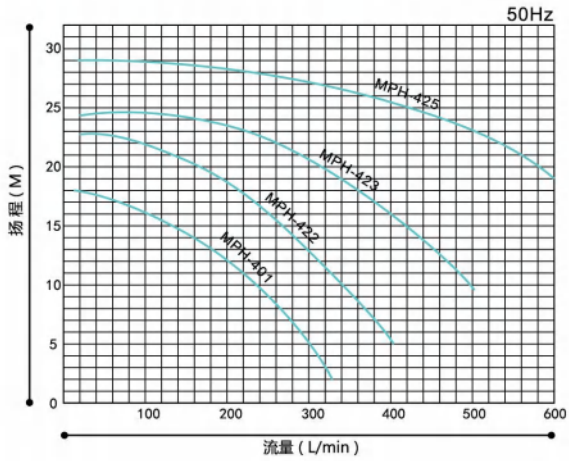

## DIMENSIONS

MP-55R

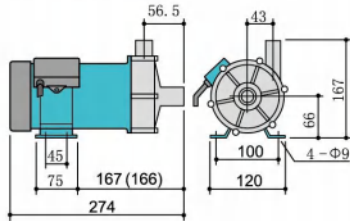

MP-70R

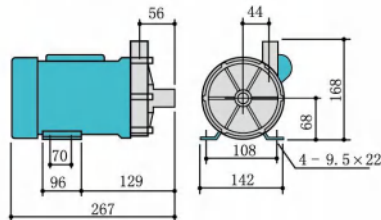

MPH401

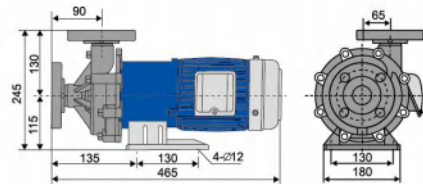

MP-70RZ

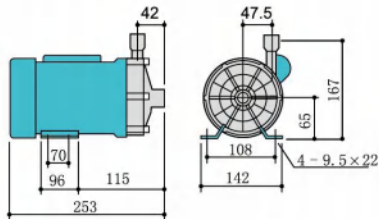

MP-100R

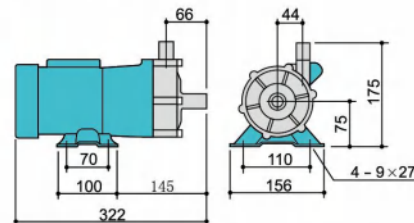

MPH422

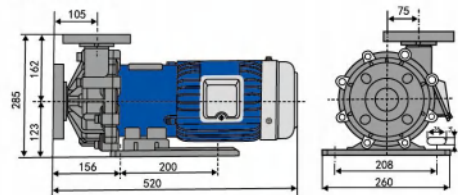

MP-120R

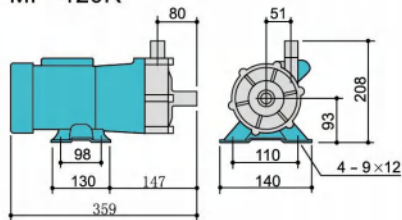

MPH423

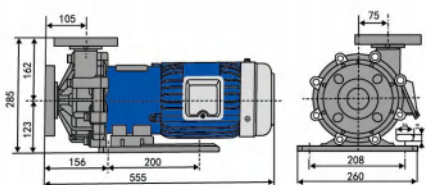

**Note:**

- 1, Thread& tube connection pump character and installation;
- 2, MP-120RT magnetic pump innovated connection design, easy to install and dismantle, adapt to household fish tank or seafish cultivation;
- 3, MPH-400 magnetic pump motor can be IEC 71 inch 0.37kw flange connection motor;
- 4, MPH-401 magnetic pump motor can be IEC 80 inch 0.75 flange connection motor;
- 5, G= UK BSP threaded;

## Chemical Resistance Guide

Chemical resistance ratings:

- A — Excellent
- B — Good
- C — Fair
- X — Not Recommended
- — Data Not Available

Maximum operating temperature:

- 1 — 20°C (68F)
- 2 — 40°C (104F)
- 3 — 60°C (140F)
- 4 — 80°C (176F)
- 5 — 100°C (212F)
- 6 — 120°C (248F)

CHEMICAL		MATERIAL						
		PP	PTFE	FKM	Chemigum	EPDM	95 Ceramic High density carbon	
Sulfuric Acid	0~10%	A4	A6	A6	B2	A4	A5	A6
	10~75%	A3	A6	A4	X	A3	A5	A6
	75~100%	B2	A4	A4	-	B2	A5	A4
Nitric Acid	10%	A3	A5	A5	X	A2	A5	A6
	30%	A2	A6	A6	X	A2	A5	A6
	50%	B2	A3	A1	X	X	A5	A5
Hydrochloric Acid	0~25%	A4	A6	A3	B1	A3	A5	A6
	25~40%	A4	A6	B2	X	C2	A5	A6
Hydrofluoric Acid	10%	B2	A6	A3	X	A3	-	A3
	30%	C2	A6	A4	-	B3	-	A3
	60%	X	A6	A4	-	C2	-	A2
Acetic Acid	20%	A2	A6	B1	B2	A2	A5	A4
	80%	B1	A6	X	-	-	A5	A4
Sodium Hydroxide	20%	A3	A6	B1	B2	A3	-	A3
	50%	A3	A6	X	B1	A4	-	A3
Bromine Water		C1	A3	A2	-	X	A1	A2
Ethyl Alcohol		A2	A3	A3	X	B3	A3	A5
Acetone		A2	A6	X	-	B2	A3	A5
Freon 12		X	A6	A1	X	B1	A4	A4
Aluminum Chloride		A4	A6	A5	B4	A4	A4	A5
Amonia Liquid		A1	A6	C1	B4	B3	A3	A5
Aqua Regia		C2	A5	B2	-	C2	A4	-
Formaldehyde		A4	A6	A4	x	A4	A4	A5
Gasolines		X	A6	B3	B3	X	A4	A6
Kerosene		A1	A6	A1	B1	X	A4	A6
Methyl Alcohol		A3	A6	B2	B4	A3	A5	A6
Toluene		C1	A4	B1	-	X	A5	A4
Trichloroethylene		C1	A6	A1	-	X	A4	A6
Xylene		X	A6	B1	-	X	A5	A5
Nitric Acid Anhydrous		C1	A3	A1	-	X	A5	A2
Oleum		X	A6	A4	-	X	A5	A2
Potassium Hydroxide		A4	A6	B1	C2	A5	-	A6

Note: 95 ceramic means containing 95 percent of alumina



## Applications

The “HAOQUAN” Brand magnetic-driven cycle pump, made by polypropylene, has an excellent performance to endure the corrosion from chemical Liquid, Its applications is very extensive.

**Chemical industry:** Sodium carbonate industry(production of hydrochloric acid, hypochlorous acids secondary chemical product); production of fluoride, chemical fertilizer; cycle of reactive liquid of gas absorb tower, abstract grease(sulfuric acid);recycle& reactivation system of waste acid substance; transport of strong acid between chemical factory and transport vehicle

**Phatmaceuticals industry:** Production of Luminophor(EL) for semiconductor, pesticides, medicine, water treatment agent

**Electric plate:** Cycle filter kinds of electroplating liquid.

**Photograph processing:** At-once photograph system; X film, wash-out of back and white, color and solid photograph

**Electric appliance:** Production of chemical capacitor(erosion by aluminum film), Transport electrolyte for manufacture of dry battery and accumulator; Etching circuit board; Transfer high purity of chemical liquid during the manufacture of semiconductor.

**Metal industry:** Treatment device for aluminum oxide film; Wire stretching; Oil elimination and cleaning and acid cleaning for steel rolling; Oil elimination and acid cleaning before painting of vehicle; production of oxidized titanium and rare-earth element.

**Mineral industry:** Fusion metallurgy(Transport and recycle electrolyte); handling waste liquid.

**Food industry:** Production of gluconic acid(hydrochloric acid); abstracting cooking oil(sulfuric acid); potted fruit industry(hydrochloric acid).

**Medicine remedy:** Man-made kidney and heart, ultrasonic washing machine and various of medical equipment.

**Water treatment:** Cleaning ion exchange resin; pure water production equipment; sea-water desalting equipment.

**Pollution control:** Add waste water treatment agent to medical liquid tank; collect and transport waste liquid; waste gas absorb equipment(deodorization equipment, desulfurisation before waste gas discharge).

**Other application:** Applied in silver recycle, wafer manufacture, laboratory-ice making machine, drinking machine, living boiler, heating exchange machine, solar energy system, dyeing, laser system, water spouting pool, rearing pond fish jar etc.



**DZ/DS**  
SERIES

## Bellows metering pump

### Model Note

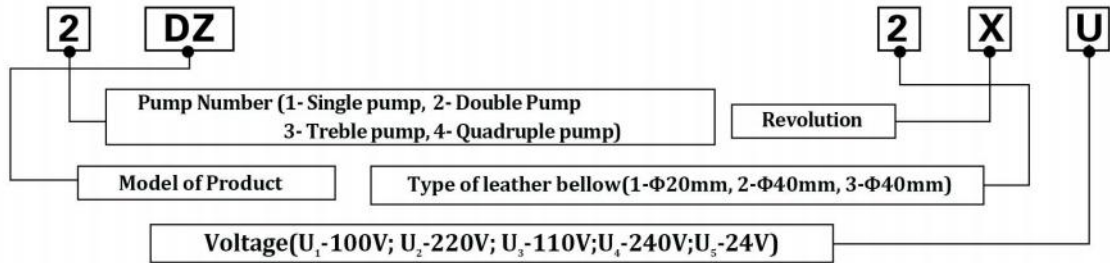

### Feature:

- △ **No leakage** For there is no mechanical sealing position, no leakage exists.
- △ **Self-suction** Suction range is 1 meter at the condition of normal atmosphere, Temperature and clean water.
- △ **Allowed to dry rotation** For working chamber bag consists of bellows, dry rotation is allowed.
- △ **Long service life** The chamber is made from polyacrylate that is anti-winding and special prescription, it can withstand countless reciprocating motion.
- △ **Anti-corrosion** Pump body is made from polyacrylate valve adopts special EPDM, FPM, resisting various acid alkali and etc, corrosive liquids.
- △ **Liquid temperature** The maximum medicinal liquid temperature is 60°C, when it is over 50°C, the highest pressure is the half of that at 20°C, when it surpasses°C, the corrosiveness of liquid may be increased(take note of it).
- △ **Precision of outlet** ±1.5% high precision can be achieved at the condition of clean water.

### DIMENSION OF STRUCTURE DRAWING

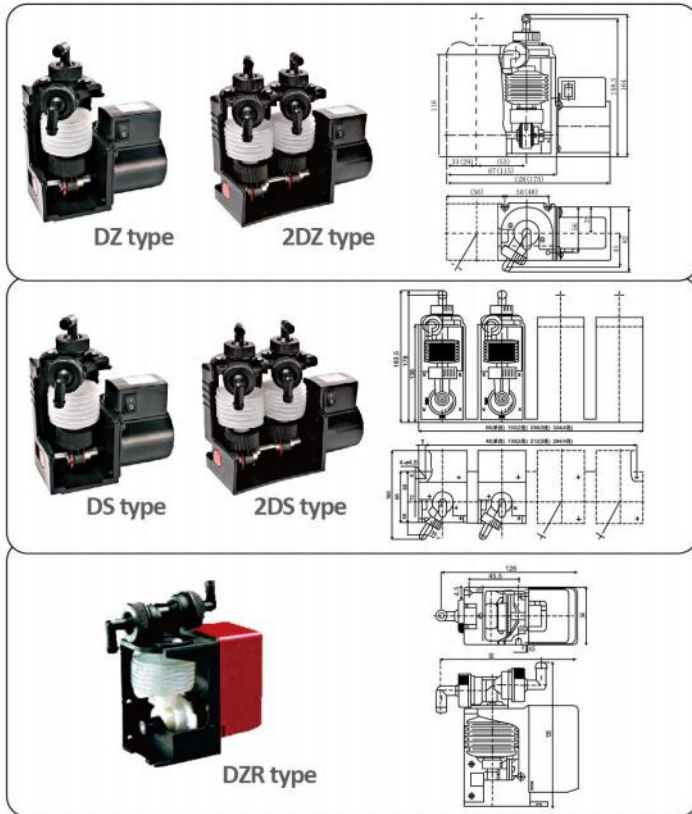

### STRUCTURAL DIAGRAM

No.	Name	Material	Quantity
1	Body	PP	2
2	Poppet valve	EPDM, CSM, FTM	2
3	Bellows	PP	1
4	Connecting Bod	PP/POM	1
5	Spindle	1Cr18Ni9Ti	1
6	Crank(B)	1Cr18Ni9Ti/POM	1
7	Crank(A)	1Cr18Ni9Ti/POM	1
8	Nut	PP	2
9	End Hoouse	ABS	1
10	Trestle	PP/PA66	1
11	Motor	/	1

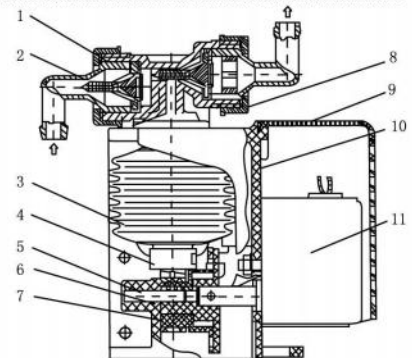



## TECHNICAL PARAMETERS

Model	Pump Number	Type of leather bellows	Max Capacity(ml/min)		Revolution(rpm)		Max pressure (Mpa)	Bore(mm)		Motor(W)	Height of self-suction (cm)
			50HZ	60HZ	50HZ	60HZ		Inlet	Outlet		
DZ-1X	Single pump	1	29	35	10	12	0.04	9	5	50	
DZ-2X		2	119	141	10	12	0.03				
DZ-2Y			175	210	15	18	0.02				
DZ-2Z			232	278	20	24	0.01				
2DZ-1X	Double pump	1	29 × 2	35 × 2	10	12	0.03	9	5	50	
2DZ-2X		2	119 × 2	141 × 2	10	12	0.02				
2DZ-2Y			175 × 2	210 × 2	15	18	0.01				
2DZ-2Z			232 × 2	278 × 2	20	24	0.01				
DZN-1X	Single pump Quadruple pump	1	29	35	10	12	0.04	9	5	50	
DZN-2X		2	119	141	10	12	0.03				
DZN-2Y			175	210	15	18	0.02				
DZN-2Z			232	278	20	24	0.02				
DS-1F	Single pump	1	115	139	40	48	0.08	9	8	100	
DS-1P			200	243	70	84					
DS-1Q			260	310	90	108					
2DS-1F	Double pump	1	115 × 2	139 × 2	40	48	0.08	9	8	100	
2DS-1P			200 × 2	243 × 2	70	84					
2DS-1Q			260 × 2	310 × 2	90	108					
DS-2E	Single pump	2	357	428	30	36	0.08	9	8	100	
DS-2F			460	552	40	48					
DS-2G			570	685	50	60					
DS-2P			798	955	70	84					
DS-2Q			990	1180	90	108					
2DS-2E	Double pump	2	357 × 2	428 × 2	30	36	0.08	9	8	100	
2DS-2F			460 × 2	552 × 2	40	48					
2DS-2G			570 × 2	685 × 2	50	60					
2DS-2P			798 × 2	955 × 2	70	84					
2DS-2Q			990 × 2	1180 × 2	90	108					
DZR-3X	Single pump	3	100	120	10	12	0.01	9	6		
DZR-3Y		3	150	180	15	18	0.01				
DZR-3Z		3	200	240	20	24	0.01				

### Applications:

- ▲ Automatic development of color film, expansion of photograph, X-ray film, microfilm, cinefilm and etc.
- ▲ It is used in beverage vending machine.
- ▲ Sticking liquid and mediation
- ▲ Quantitative replenishment of food additive.
- ▲ The etching and cleaning of electronic basicplate printing circuit.
- ▲ The neutralization of acid and alkali for water treatment the utilization of condensation separtion agent.
- ▲ Quantitative supply of electroplate liquid.
- ▲ Widely used in quantitative priming of additive, bleaching liquid and medical agents.

## DP series Diaphragm Pump Characteristic

- ▲ Easily install and dismantle
- ▲ Excellent self suction capacity
- ▲ Pump controlled automatically by built-in pressure switch
- ▲ Permissible liquid temperature up to 60°C
- ▲ Low Noise, Excellent Corrosion Resistance, High Pressure



## Specifications

Model	Voltage (V)	Max. Current (A)	Max. Flow G/min	Speed (r/min)	Pressure(max) Psi(Mpa)	Suction (m)	Pressure switch psi(Mpa)	Power (w)
DP-35	24	4.8	3.2(12)	1300	35 (0.24)	5	35 (0.24)	40
	12	7	2.5(9.5)	1200	35 (0.24)	5	35 (0.24)	40
DP-60A	24	3	1.3(5.0)	1200	60 (0.42)	5	/	40
	12	6	1.3(5.0)	1200	60 (0.42)	5	/	40
	220	0.42	1.3(5.0)	1200	60 (0.42)	5	/	40
DP-60A brushless	12	5	1.3(5.0)	1200	60 (0.42)	5	/	20
DP-60	24	3	1.3(5.0)	1200	60 (0.42)	5	60(0.42)	40
	12	6	1.3(5.0)	1200	60 (0.42)	5	60(0.42)	40
	220	0.42	1.3(5.0)	1200	60 (0.42)	5	60(0.42)	40
DP-60 brushless	24	2.8	1.3(5.0)	1200	60 (0.42)	5	60(0.42)	28
	12	5	1.3(5.0)	1200	60 (0.42)	5	60(0.42)	20
DP-100A	24	1.1	0.3(1.2)	375	100 (0.68)	5	/	10
DP-100	24	1.1	0.32(1.2)	375	100 (0.68)	5	100(0.68)	10
DP-125	24	1	0.26(1.0)	375	125 (0.86)	5	125(0.86)	10
DP-130B	24	1.2	0.45(1.7)	470	130 (0.90)	5	125(0.86)	15
	12	2.2	0.45(1.7)	470	130 (0.90)	5	125(0.86)	15
DP-130	24	1.2	0.45(1.7)	470	130 (0.90)	5	/	15
	12	2.2	0.45(1.7)	470	130 (0.90)	5	/	15
DP-150	12	4	0.68(2.6)	720	150 (1.00)	5	/	30
	24	2.4	0.68(2.6)	720	150 (1.00)	5	/	30
DP-50	24	6	4.2(16)	1800	50(0.35)	5	50(0.35)	65
	12	12	4.2(16)	1500	50(0.35)	5	50(0.35)	65
Accord to customer' needs to revise parameter								
Note: Only 220V is AC, others are DC								



## Performance curves

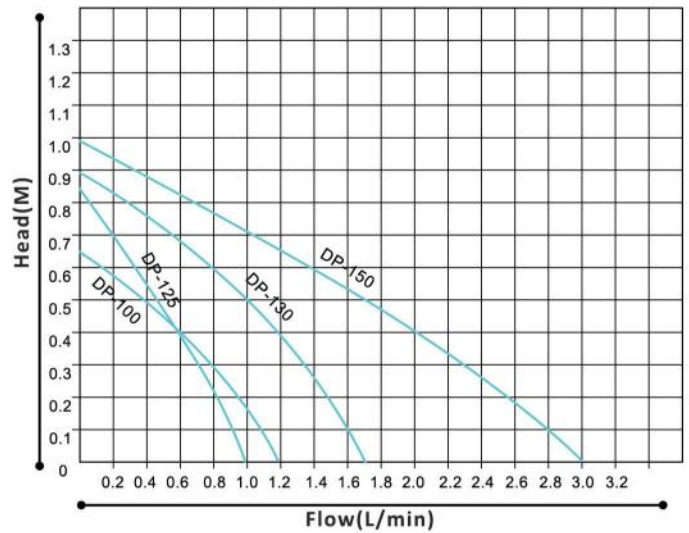
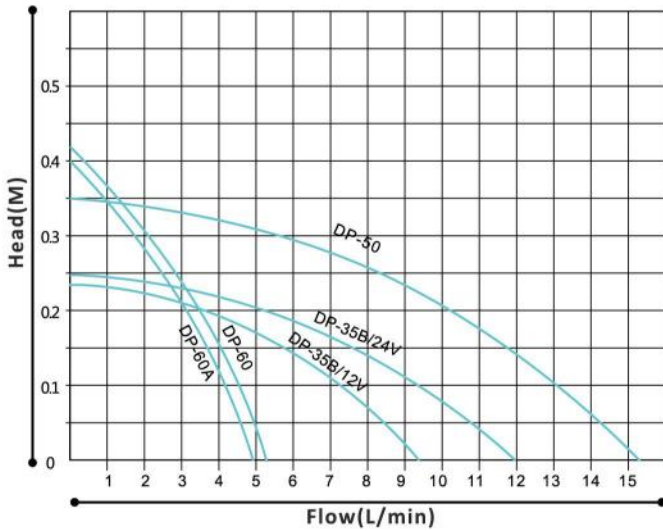

## DIMENSIONS

DP-35 · 50

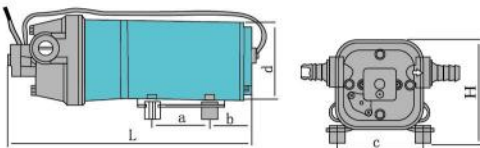

DP-60 · 100 · 125

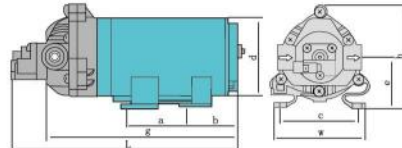

DP-130 · 150

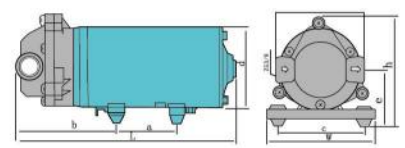

Model	a	b	c	d	H	L
DP-35	57	50	78	Φ 76	94	238.5
DP-50						

Model	a	b	c	d	e	g	h	L	W
DP-60	57	42	83	Φ 76	45	185	101	217(190)	83
DP-100									
DP-125								191.5	
DP-130	57	95	81	Φ 78	54.5	-	105	209(241)	102
DP-150									

Thailand Distributor :

Energy Power Save CO.,LTD

442/2 Chan Road, Thung Watdon Sathon Bangkok Thailand 10120

Office Tel : +66 (02) 114 7145-9 Ext. Sales. Email : info@7-mars.com