

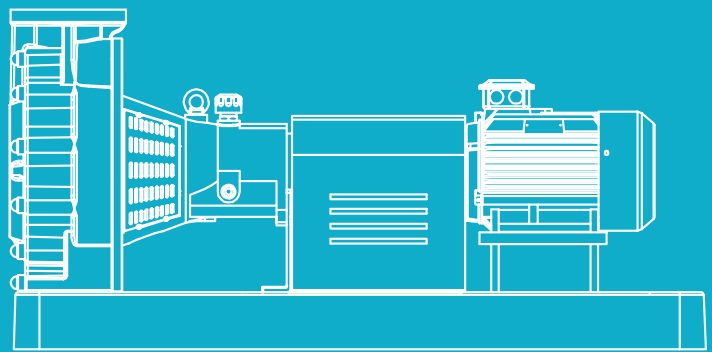

CORROSION RESISTANT FRP PUMP

SWP Series Owner's Manual

Installation and Operation



USER MANUAL

TABLE OF CONTENT

PAGE	
3 WARNINGS AND SAFETY INSTRUCTIONS GENERAL WARNING
4 SUCTION ENTRAPMENT HAZARD
5 1. INTRODUCTION
	1.1 QUALITY GUARANTEE
	1.2 GENERAL INFORMATION
	1.3 RIGHTS AND DISCLAIMER
	1.4 SIGNS
	1.5 WARRANTY
	1.6 SAFETY
6 2. SWP SERIES FRP PUMP OVERVIEW
	2.1 MECHANICAL SEAL
	2.2 SPACER COUPLING
	2.3 PRODUCT INFORMATION
	2.4 PRODUCT DIMENSION
	2.5 KEY MATERIALS
	2.6 PUMP PERFORMANCE CURVES CURVE
	2.7 TECHNICAL DATA (@380~400Vac 50Hz)
22 3. TRANSPORTATION AND STORAGE
	3.1 PACKAGING
	3.2 TRANSPORTATION, LOADING AND UNLOADING, RAISING
	3.3 TESTING
	3.4 STORAGE
23 4. INSTALLATION
	4.1 POSITION THE PUMP TO ENSURE THAT
	4.2 SUPPORTING BASE
	4.3 BASE AND FOUNDATION
	4.4 DRAINING PIPES ON THE BASE
	4.5 ALIGNMENT
	4.6 PIPES
	4.7 WATER INLET PIPE
	4.8 OPTIONAL PRE-FILTER
	4.9 INSTALLATION EXAMPLE WITH PRE-FILTER
	4.10 FLANGE INSTALLATION
27 5. ELECTRICAL WIRING
	5.1 ELECTRICAL WIRING - 3 PHASE
	5.2 DIRECT ON LINE STARTER
	5.3 STAR-DELTA STARTER
	5.4 VARIABLE FREQUENCY DRIVE (VFD)
	5.5 SOFT STARTER
	5.6 MOTOR CURRENT RATING ESTIMATION
	5.7 MOTOR SPECIFICATION

SWMP SERIES

Corrosion Resistant FRP Pump

PAGE	32	6. START UP
			6.1 ROTATING DIRECTION
			6.2 INITIAL TESTING OF THE WATER PUMP
			6.3 INITIAL TESTING OF THE MOTOR
			6.4 STARTING
			6.5 WORKING STATUS
			6.6 TEMPERATURE
			6.7 THE WORKING TEMPERATURE OF THE BEARINGS
			6.8 FLOW RANGE
			6.9 NOISE VALUE
	34	7. MAINTENANCE
			7.1 PROPHYLACTIC MAINTENANCE
			7.2 DAILY CHECKING AND MAINTENANCE
			7.3 ADDITIONAL MAINTENANCE
			7.4 LUBRICATING OIL
			7.5 FREEZING LIQUID IN THE PUMP
			7.6 DRAINING AND CHANGING OF THE LIQUID IN WATER PUMP
			7.7 IDLING RUNNING
			7.8 IMPURITY OF THE LIQUID IN WATER PUMP
			7.9 SUGGESTED SPARE PARTS
			7.10 REPAIRS
			7.11 DISMANTLING
			7.12 PRE-FILTER ROUTINE MAINTIANCE
			7.13 WINTERIZING
	38	8. DESCRIPTION OF SEA WATER PUMP PART
			8.1 EXPLODED DIAGRAM OF THE WATER PUMP
			8.2 PARTS LIST
			8.3 DESCRIPTIONS OF MAIN PARTS
			8.4 BREAK-OUT SECTIONS OF MAIN PARTS
	40	9. TROUBLE SHOOTING
	42	10. TERMS OF THE WARRANTY

WARNINGS AND SAFETY INSTRUCTIONS

GENERAL WARNING

This instruction contain general caution information for use in Pool and SPA pump installation application. Specified Pump model function should be refer to particular manual. Components such as the filtration system, pumps and heater must be positioned so as to prevent their being used as means of access to the pool by young children.



RISK OF ELECTRICAL SHOCK

This appliance should be installed by qualified electrical personnel in accordance with National Electrical Code and all applicable local codes and ordinances. Hazardous voltage can shock, burn, and cause death or serious property damage. DO NOT use an extension cord to connect unit to electric supply to reduce the risk of electric shock.

1. The pump should be permanently connected to an individual circuit breaker.
2. Pump must be connected to a residual current device (RCD) having a rated residual operating current not exceeding 30 mA or receptacle with ground fault circuit interrupt (GCFI).
3. Electrical grounding must be connected before connecting to electrical power. Failure to ground all electrical equipment can cause serious or fatal electrical shock hazard.
4. Bonding: Use at least #8 AWG (#6 AWG for Canada) a solid copper conductor, run a continuous wire from external bonding lug (if available) to the pressure wire connector provided on the electrical equipment and to all metal parts of swimming pool, spa, or hot tub, and metal piping (except gas piping), and conduit within 1.5 m (5 ft) of inside walls of swimming pool, spa, or hot tub.
5. Never open the inside of the drive motor enclosure. There is a capacitor bank that holds a mains supply voltage charge even when there is no power to the unit. The voltage should be referred to the individual pump operation voltage.
6. The pump is capable of high flow rates; use caution when installing and programming to limit pumps performance only.
7. Switch OFF pump power before servicing and disconnecting the main circuit to the pump.
8. Never change the filter control valve position while the pump is running.



COMPRESS AIR HAZARDOUS

This system enclosed pre-filter / filter and become pressurized. Pressurized air can cause the Lid to separate which can result in serious injury or death.

STAND CLEAR OF PUMP DURING START-UP

Pool and spa circulation systems operate under high pressure. When any part of the circulating system (i.e. lock ring, pump, filter, valves, etc.) is serviced, air can enter the system and become pressurized. Filter tank Lid and pre-filter cover must be properly secured to prevent violent separation. Place pre-filter / filter air relief valve in the open position and wait for all pressure in the system to be relieved before remove the lib to access the basket for cleaning.



HYPERTHERMIA

SPA water temperature excess 38°C (104°F) may be injurious to health. Measure water temperature before entering SPA.

Hyperthermia occurs when the internal temperature of the body reaches a level several degrees above the normal body temperature of 98.6 °F (37 °C). The symptoms of hyperthermia include drowsiness, lethargy, and an

increase in the internal temperature of the body.



SUCTION ENTRAPMENT HAZARD

This pump produces high levels of suction and creates a strong vacuum at the main drain at the bottom of your pool and spa. This suction is so strong that it can trap adults or children under water if they come in close proximity to a pool or spa drain or a loose or broken drain cover or grate.

The Virginia Graeme Baker (VGB) Pool and Spa Safety Act creates new requirements for owners and operators of commercial swimming Pools and spas.

Commercial pools or spas constructed on or after December 19, 2008, shall utilize:

1. A multiple main drain system without isolation capability with suction outlet covers that meet ASME/ANSI A112.19.8a Suction Fittings for Use in Swimming Pools, Wading Pools, Spas, and Hot Tubs and either:
 - 1.1 A safety vacuum release system (SVRS) meeting ASME/ANSI A112.19.17 Manufactured Safety Vacuum Release systems (SVRS)
For Residential and Commercial Swimming Pool, Spa, Hot Tub, and Wading Pool Suction Systems and/or ASTM F2387 Standard
Specification for Manufactured Safety Vacuum Release Systems (SVRS) for Swimming pools, Spas and Hot Tubs or
 - 1.2 A properly designed and tested suction-limiting vent system or
 - 1.3 An automatic pump shut-off system.

Commercial pools and spas constructed prior to December 19, 2008, with a single submerged suction outlet shall use a suction outlet cover that meets ASME/ANSI A112.19.8a and either:

1. A SVRS meeting ASME/ANSI A112.19.17 and/or ASTM F2387, or
2. A properly designed and tested suction-limiting vent system, or
3. An automatic pump shut-off system, or
4. Disabled submerged outlets, or
5. Suction outlets shall be reconfigured into return inlets.

There are five types of suction entrapment according to The Virginia Graeme Baker (VGB) Pool and Spa Safety Act

1. **Body Entrapment** a section of the torso becomes entrapped
2. **Limb Entrapment** an arm or leg is caught by or pulled into an open drainpipe
3. **Hair Entrapment** or entanglement hair is pulled into and/or wrapped around the grate of the drain cover
4. **Mechanical Entrapment** the bather's jewelry or clothing gets caught in the drain or the grate
5. **Evisceration** the victim's buttocks come into contact with the pool suction outlet and he or she is disemboweled



TO REDUCE ENTRAPMENT HAZARD RISK



WARNING:

Two function suction outlets per pump must be installed to prevent entrapment. The minimum separate of suction on the same plate must be at least point to point measurement 1 meter (3ft) apart. It is used to avoid "dual blockage" by bather.

If suction is found damage, broken, cracked, missing or not securely attached during regular checking, shunt down the pool and replace it immediately.

A vacuum release or vent system is recommended to install for suction entrapment release.

1. INTRODUCTION

1.1 QUALITY GUARANTEE

The manufacturer guarantees that the SWP water pump is manufactured in accordance with standard design which covers motor, baseboard, connecting parts as well as their protectors, which are all made to the relevant DIN standard.

The Unified Standards only ensure normal operation in the working environment and for the purpose for which it is designed; clients have the responsibility to ensure that the water pump work in proper working environment.

Guarantees are invalidated if any alterations have been made to the equipment, or it is operated in an improper working environment, or used for a purpose for which it is not designed.

This statement only approves the water pumps being installed and used in accordance with the production processes approved by the manufacturer. The circulation system of the water pump should be done in accordance with standards.

If clients only need water pumps with shaft, they should install the whole water pump in accordance with specifications made by the manufacturer and should ensure that it is in accordance with GB standards before the running of the pump.

1.2 GENERAL INFORMATION

The purpose of this manual is to ensure that safety use of the equipment. The function of this pump is only guaranteed if it is used according to the instructions.

The equipment should be used in compliance with national standards and safety regulations which may not be specified in this manual.

Keep this manual near the pump or attach it directly to the pump. The specification should be read before the pump is installed, used and serviced.

Failure to operate the pump according to the instructions may invalidate the guarantee and cause injury to the operator. This instruction manual only applies to this pump and is not valid for any other pumps in the system.

1.3 RIGHTS AND DISCLAIMER

The information provided in this manual is taken as standard. The manufacturer is not responsible for the information missing in this manual. Users should read the information contained in this manual, and any possible errors should be reported to the manufacturer.

All rights reserved. Without approval from the manufacturer, any information in this manual may not be reproduced in any form, re-stored and transferred to individuals for any purpose.

1.4 SIGNS

Each water pump is fitted with a nameplate containing the information required by GB standards.

All pumps have a rating and information plate required by GB standards. The information, codes and serial number should be provided when ordering spare parts.

1.5 WARRANTY

All water pumps are covered by the manufacturer's guarantee of quality and any manufacturing defects are covered by this warranty. The warranty is valid for one year beginning from the date of production (the date specified on invoice) or six months starting from the date of installation, during which the manufacturer will undertake all the costs of maintenance and changing parts. The warranty covers the replacement of defective parts due to the manufacturing process only; damaged caused by improper use or installation are not covered by the warranty.

1. The company will not be responsible for the damage caused by;
2. Allowing the pump to run dry or running with insufficient water supply;
3. Incorrect installation or foreign matter in the pump;
4. Use of the pump for liquids other than those specified by the manufacturer;
5. Irregular flow rate;

Exceeding the total pump head or operation outside recommended temperatures.

Water hammer effects

Transport damage

Damage caused due to operation by non-qualified personnel.

Warranty clause doesn't include direct or indirect compensation for loss of goods and physical injury caused by the abnormal running of the water pump, or during the time of maintenance (manufacturer or the third party).

Self-repairs without consulting the manufacturer will invalidate the warranty.

The use of replacement parts supplied by third party suppliers will invalidate the warranty.

The warranty does not cover shipping costs to and from the manufacturer

Repairs under warranty do not affect the warranty term of this product.

The warranty does not cover vulnerable parts.

Warranty will be invalidated if the equipment is not operated according to the instructions in this manual.

1.6 SAFETY

The pump should only be installed, tested, and operated by sufficiently qualified personnel. Proper training can be provided by the manufacturer - please ask for a quotation.

All standard parts have been tested for quality and durability under long time running times. The use of third party parts may result in loss of performance or cause safety problems. Any damage caused by improper using is excluded from the warranty clause. Any alteration to the water pump or the dismantling of original parts will affect the safety of the pump.

This manual contains detailed safety signs, all of which are listed in the following part. Unfamiliar to one or more signs may lead to harm to the operator.

2. SWP SERIES FRP PUMP OVERVIEW

The SWP Series is a corrosion resistant FRP horizontal centrifugal single-stage pumps designed to ISO 5199-2002 centrifugal Pump – Class II standard. The pump body material in fiberglass reinforced polyester is resistant to sea water and chemicals such as dilute solutions of hydrochloric, sulphuric, nitric, phosphoric acids; acetic acid, vinegar, and fatty acids.

The Emaux SWP series pumps are manufactured using the latest FRP technology in pump body and impeller. The compression molding process ensures a uniform thickness reducing warpage and saving material.

The IE3 class Motor design ensures premium efficiency and a low noise level.

The special impeller designed by computational fluid dynamics (CFD) optimizes the performance beyond that of other comparable pumps.

High water flow impeller design by computational fluid dynamics (CFD) analysis optimize the pump performance than comparable pumps.

Optional detachable large volume pre-filter with its heavy duty PVC basket is designed for a high flow rate and flexible installation.

The standard flange designed to DIN PN10 is compatible with different piping systems.

Compared with Stainless Steel, Fiberglass has better anti-corrosion effects

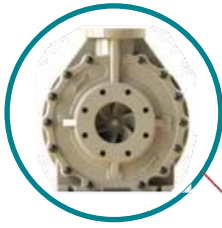

Mechanical Seal with Internal Cool Down and Clean Up Channel

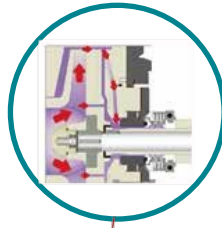

High Efficient Impeller

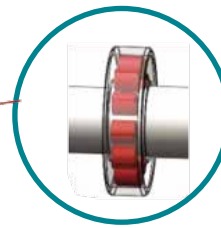
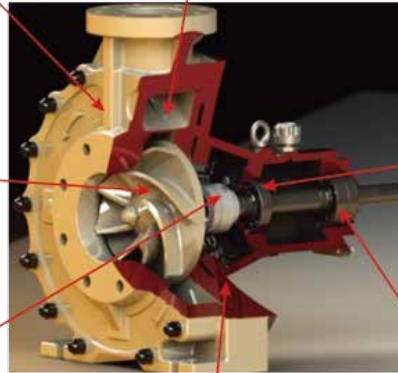

High Efficient SKF Ball Bearings provides longer life compared to conventional Ball Bearings

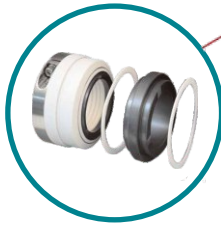

External type AISI-316L mechanical seal for highly corrosive fluids, static and rotating rings in SiC, spring and Polyester thermosetting powder coated power frame construction to prevent external corrosion



316L Stainless Steel with corrosion resistance

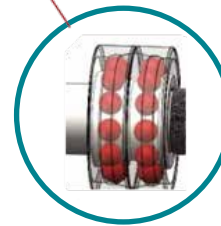

Double Row Ball Bearings enhance efficiency and provide power savings to extend product life

2.1 MECHANICAL SEAL

The mechanical shaft seal with parts coated in with low friction silicon carbide and PTFE is more suitable for sea water use than traditional mechanical seals which wear out much more quickly.

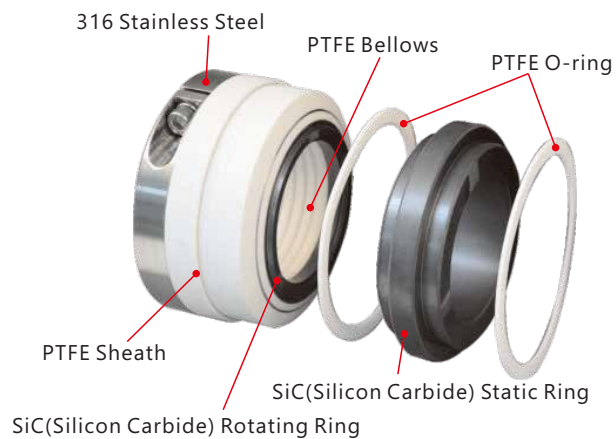
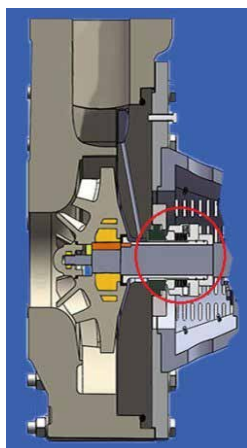

Normal pre-filters are not able to filter suspended solids that wear and damage the sealing surfaces after long run. The Emaux mechanical seal is designed to overcome the problems associated with the complex environment of sea water which causes corrosion directly or indirectly.

2.2 SPACER COUPLING

Spacer coupling uses a metal diaphragm to join the main and driven shafts and transmit the torque. This elastic coupling reduces vibration and noise and needs no lubrication, while compensating for changes in temperature and axial, radial, or angular offset.

A diaphragm coupling offers the following advantages:

1. Damping effect and significant reduction of noise, wear and tear
2. High Efficiency – up to 99.86%, especially suitable for medium and high power speed transmission
3. High flexibility provides compensation on positional deviation of axial, radial or angular offset
4. Accommodation of large temperature differences(-80°C ~ +300°C) under extreme environments under shock and vibration conditions
5. Designed with simple structure, light weight and small size
6. Easy removal for maintenance without moving the machine itself (Intermediate shaft system)
7. Accurate speed transmission, slip-free operation for precise torque transmission.

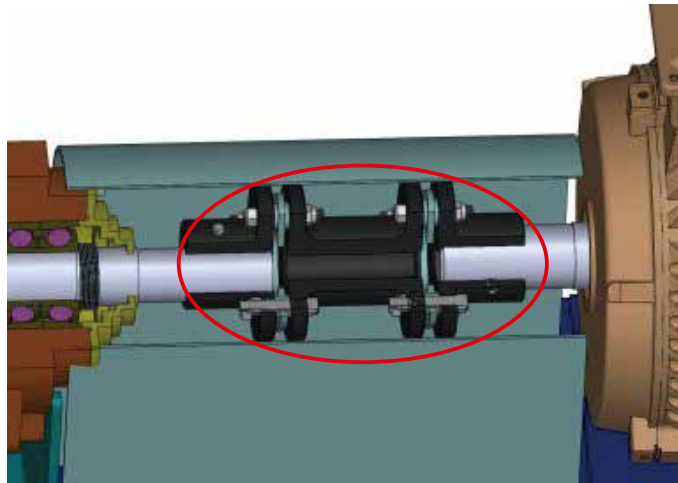

100X80 Coupling



150X100 Coupling



200X150 Coupling

2.3 PRODUCT INFORMATION

Code	Model	Inlet x Outlet x Impeller Dia (mm)	RPM	Power		Weight(kg)
				hp	kW	
9023512	SWP550-6P	150 x 100 x 250	950	5.5hp	4.0kW	420
9023513	SWP750-6P	150 x 100 x 270	950	7.5hp	5.5kW	435
9023514	SWP1000-6P	200 x 150 x 270	950	10.0hp	7.5kW	643
9023515	SWP1500-6P	200 x 150 x 300	950	15.0hp	11.0kW	665
9023516	SWP6000-6P	300 x 250 x 405	950	60.0hp	45.0kW	1020
9023503	SWP550-4P	100 x 80 x 205	1450	5.5hp	4.0kW	285
9023504	SWP750-4P	100 x 80 x 220	1450	7.5hp	5.5kW	300
9023505	SWP1000-4P	150 x 100 x 225	1450	10.0hp	7.5kW	417
9023506	SWP1500-4P	150 x 100 x 250	1450	15.0hp	11.0kW	480
9023501	SWP2000-4P	200 x 150 x 250	1450	20.0hp	15.0kW	647
9023502	SWP2500-4P	200 x 150 x 265	1450	25.0hp	18.5kW	677
9023509	SWP3000-4P	200 x 150 x 280	1450	30.0hp	22.0kW	694
9023511	SWP4000-4P	200 x 150 x 295	1450	40.0hp	30.0kW	763
9023518	SWP5000-4P	200 x 150 x 310	1450	50.0hp	37.0kW	796
9023510	SWP6000-4P	200 x 150 x 325	1450	60.0hp	45.0kW	828
9023507	SWP1000-2P	100 x 80 x 155	2900	10.0hp	7.5kW	322
9023508	SWP1500-2P	100 x 80 x 170	2900	15.0hp	11.0kW	345
9023517	SWP2000-2P	100 x 80 x 185	2900	20.0hp	15.0kW	358
9023519	SWP2500-2P	100 x 80 x 200	2900	25.0hp	18.5kW	377

2.4 PRODUCT DIMENSION(mm)

Body (Motor - 4P)	L1 (mm)	B1 (mm)	H1 (mm)	H2 (mm)	H3 (mm)	H4 (mm)	H5 (mm)	DN1 (inch / mm)	DN2 (inch / mm)	ØD (mm)	A1 (mm)	A2 (mm)
100 x 80	1200	420	100	210	310	590	112	4"/100	3"/80	458	102	78
100 x 80	1200	420	100	210	310	590	132	4"/100	3"/80	458	102	78
150 x 100	1450	480	100	254	354	697	132	6"/150	4"/100	540	102	78
150 x 100	1450	480	100	254	354	697	160	6"/150	4"/100	540	102	78
200 x 150	1530	570	100	368	468	874	160	8"/200	6"/150	700	152	93
200 x 150	1530	570	100	368	468	874	180	8"/200	6"/150	700	152	93
300 x 250	2032	600	100	457	557	1217	280	12"/300	10"/250	1003	97	203

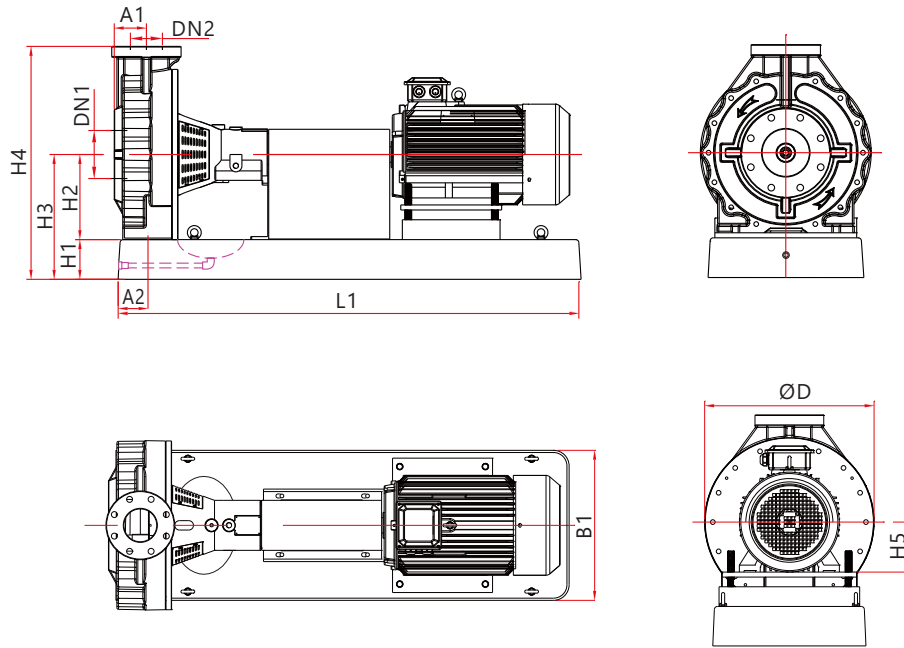

2.5 KEY MATERIALS

1. Flow-through parts: Fiber Reinforce Plastic (FRP) *Vinyl ester resin.
2. Impeller: High efficiency semi open type
3. Pump shaft, bearing box: 316L Stainless steel
4. Motor type: ABB motor, IE3 Premium Efficiency variable frequency drive
5. Motor. Fully sealed air cooled type (TEFC) 380V/50Hz, 1450RPM
6. Bearing: Super power SKF roller bearings and double row bearings
7. Mechanical Seal: PTFE/SIC /316 stainless steel material external mechanical seal (Internal circulation cooling)
8. Fiber reinforced plastic base

2.6 PUMP PERFORMANCE CURVES CURVE

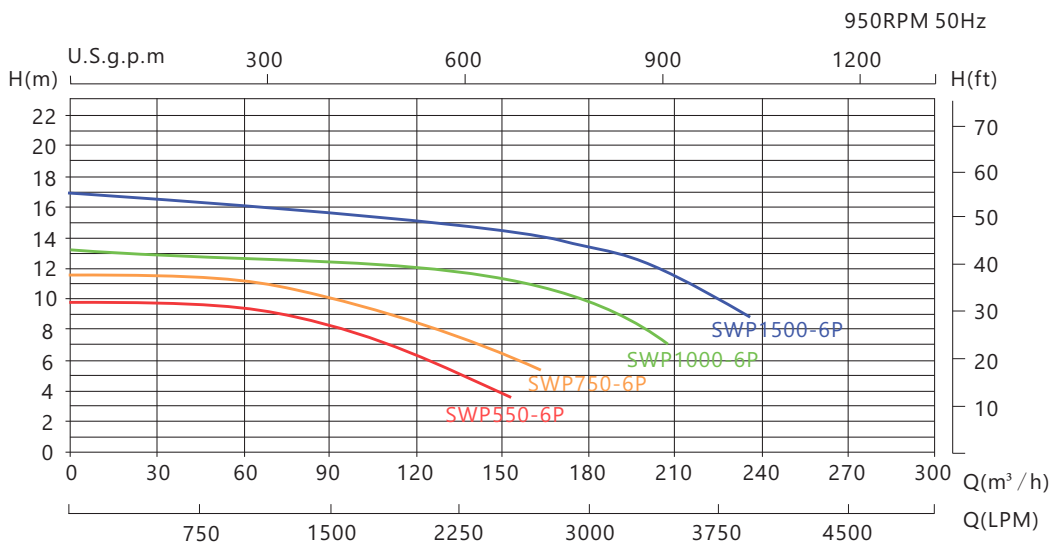

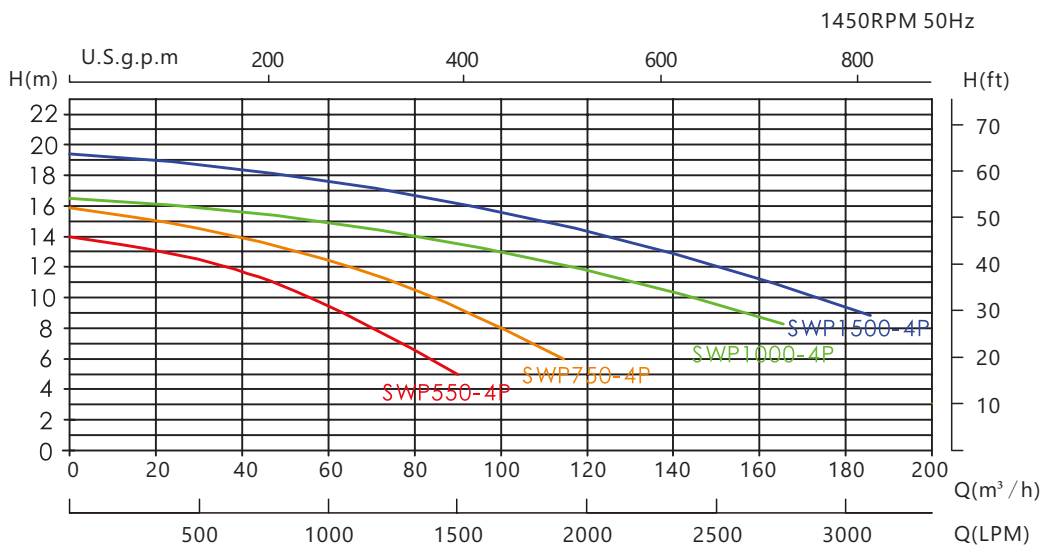
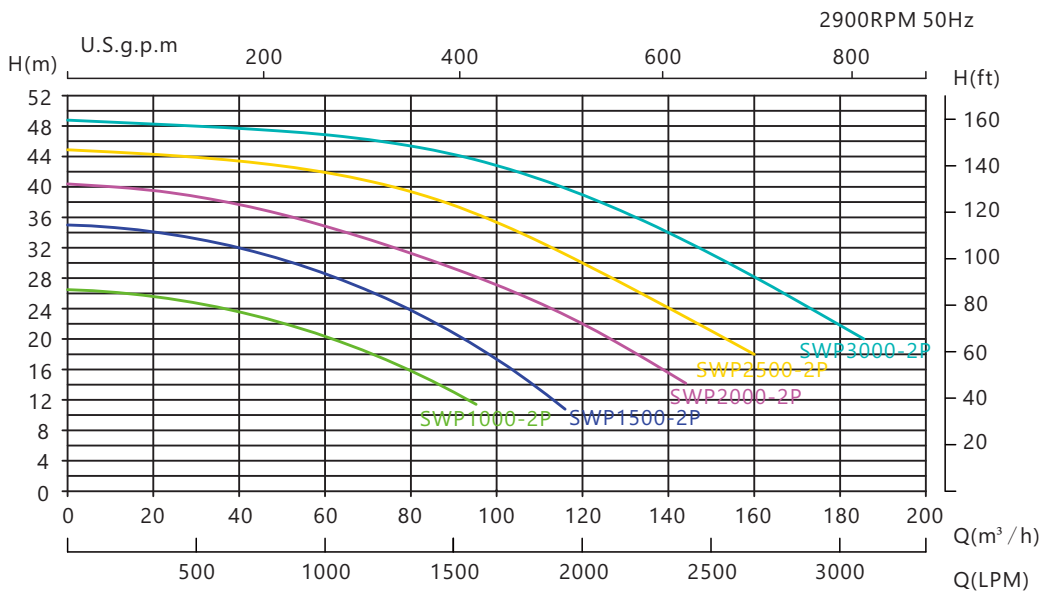
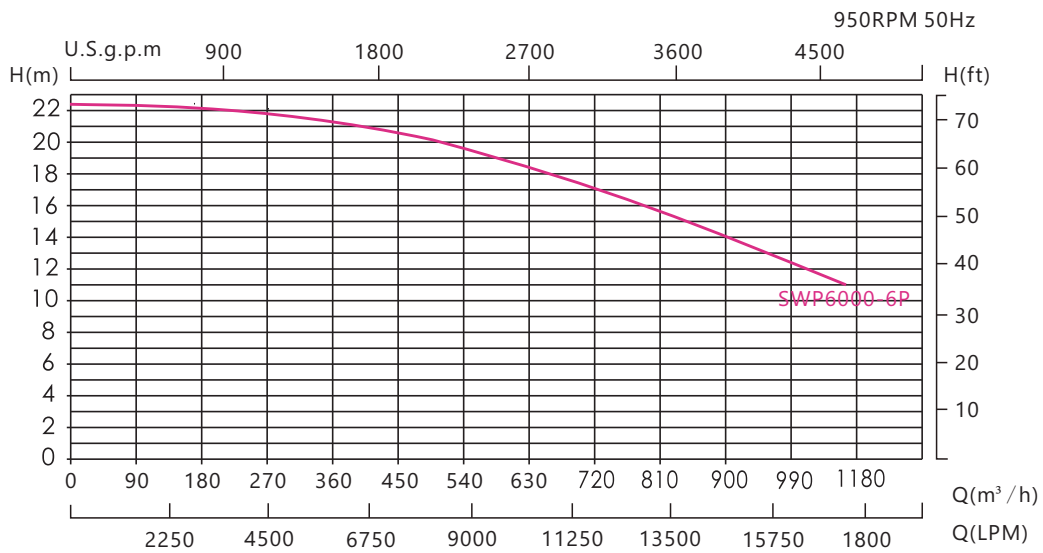

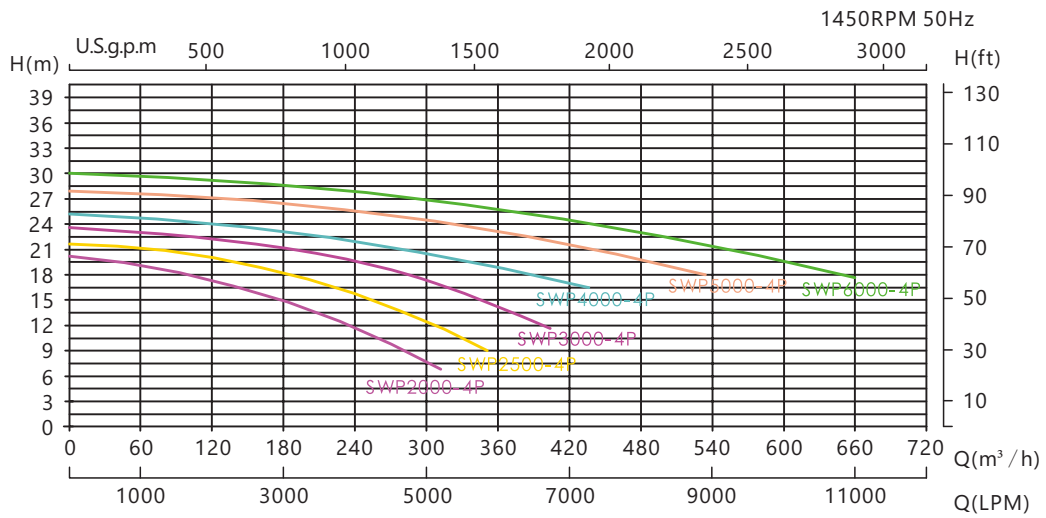

2.7 TECHNICAL DATA (@380~400Vac 50Hz)

SWP 550-6P

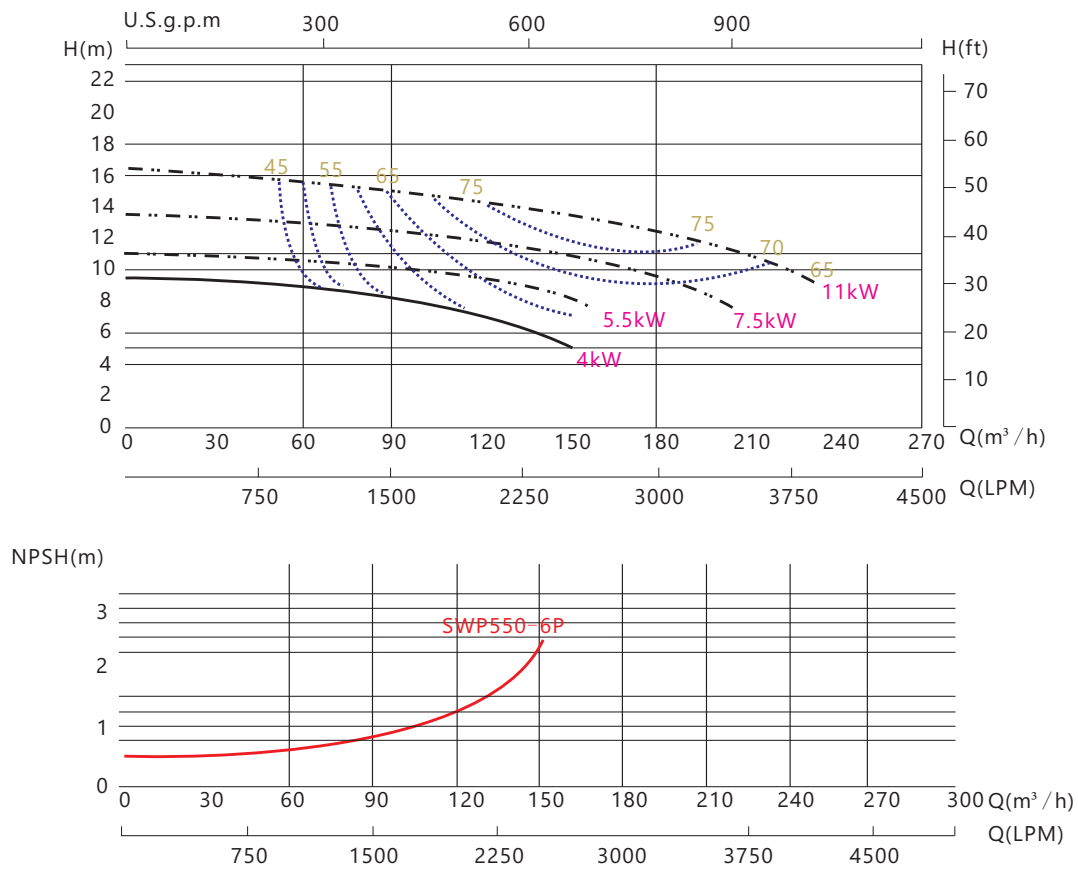

SWP750-6P

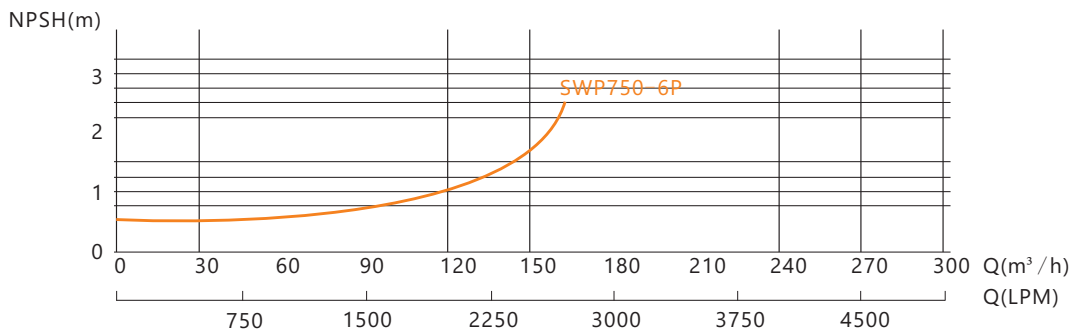
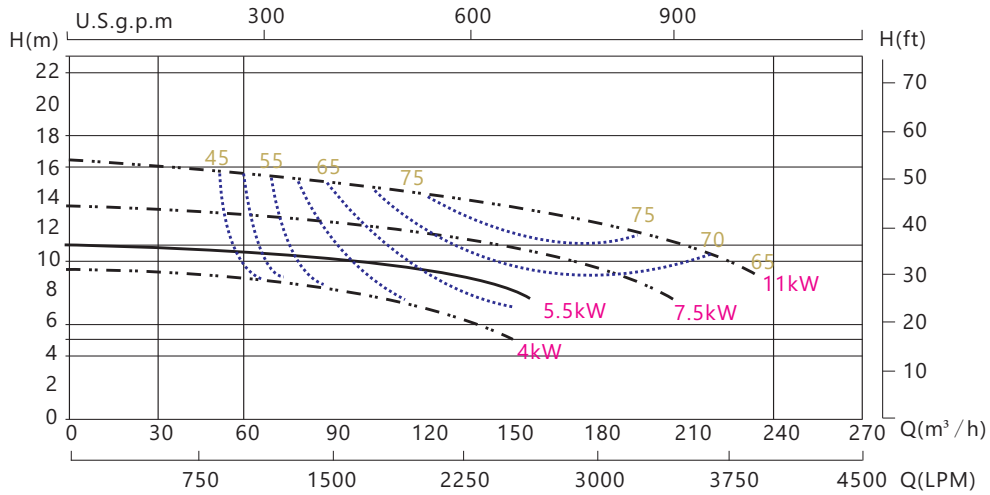

SWP1000-6P

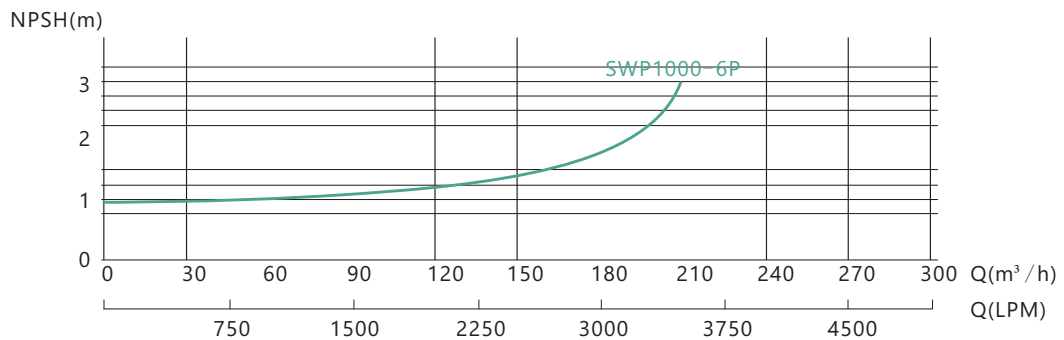
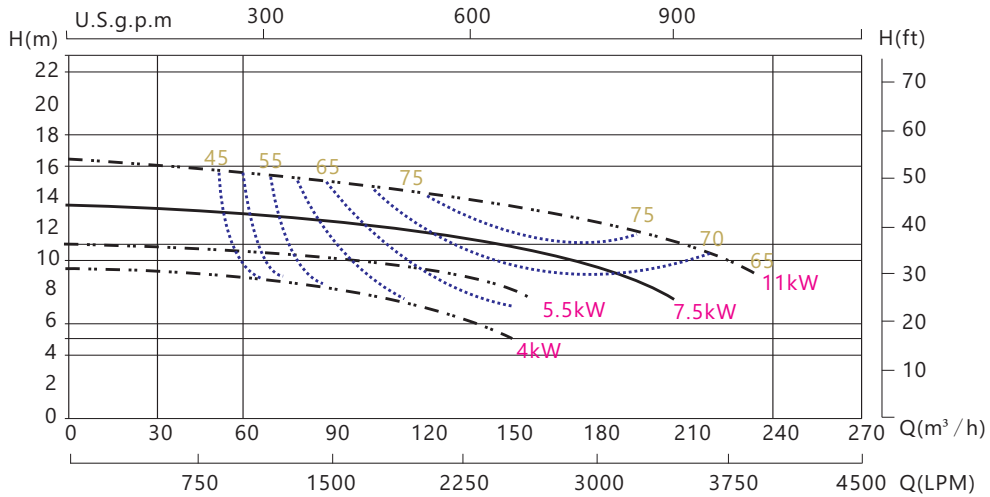

SWP1500-6P

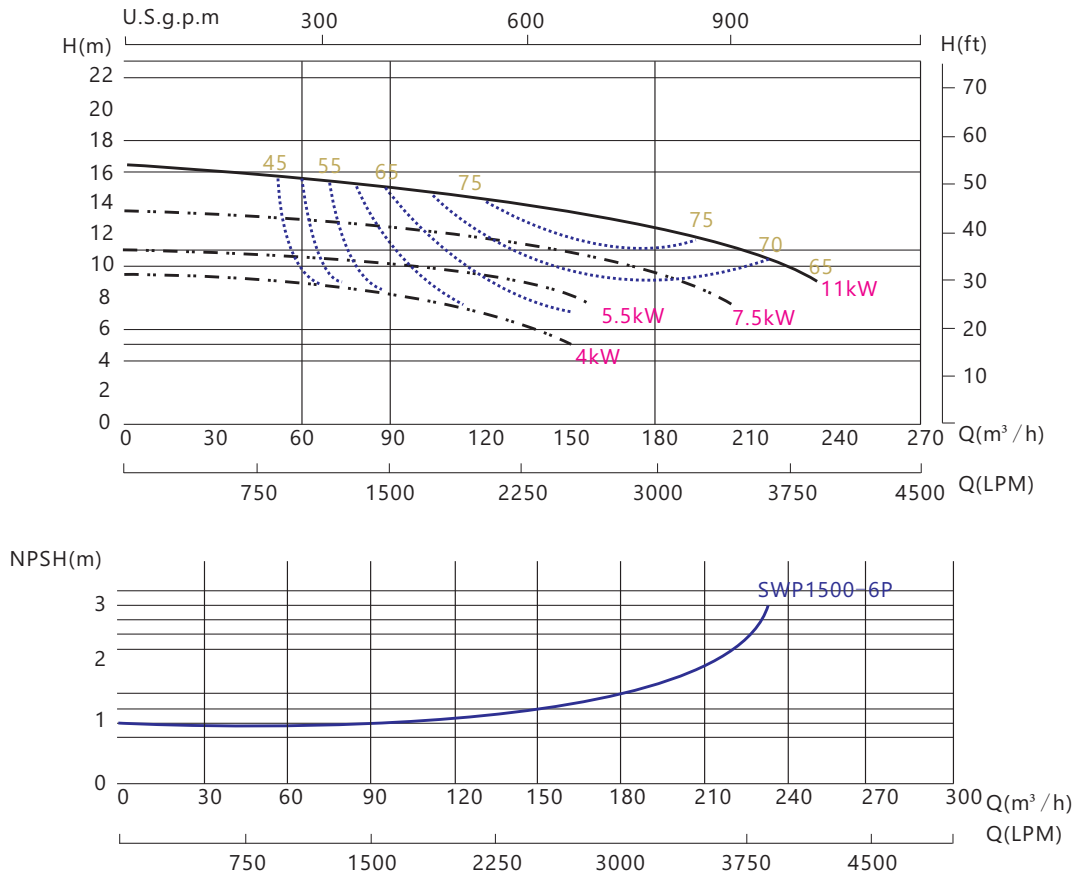

SWP550-4P

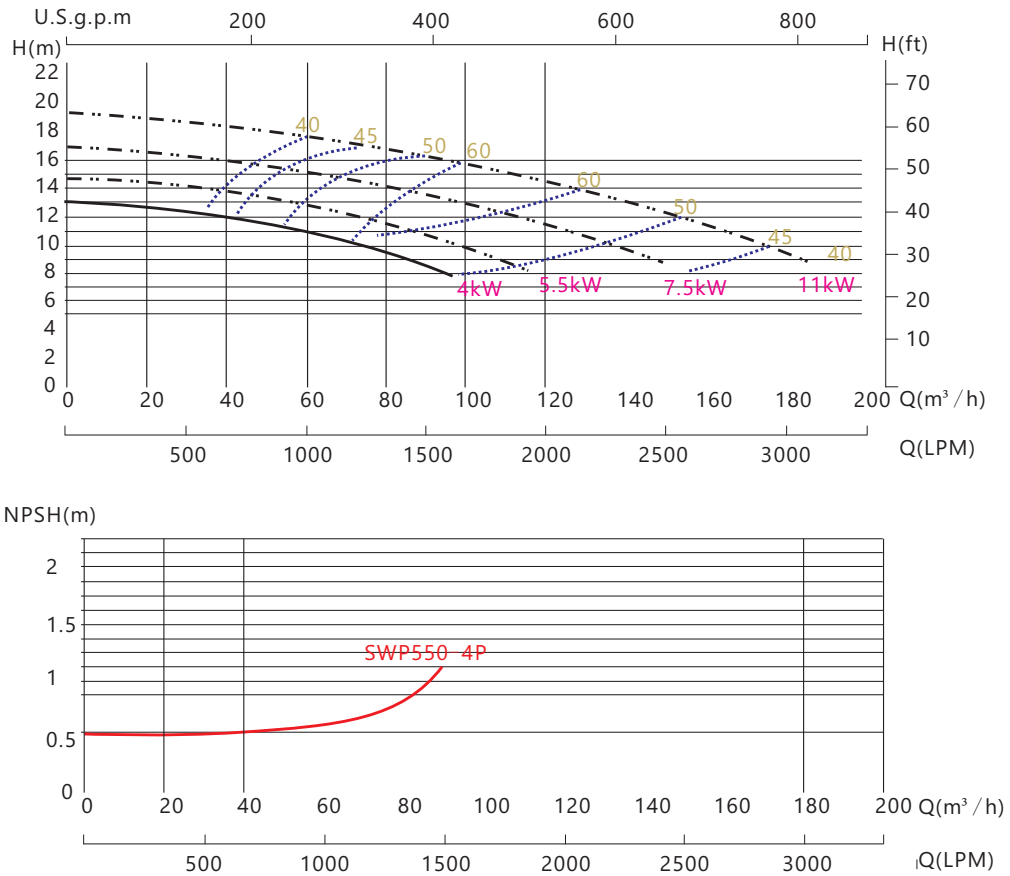

SWP750-4P

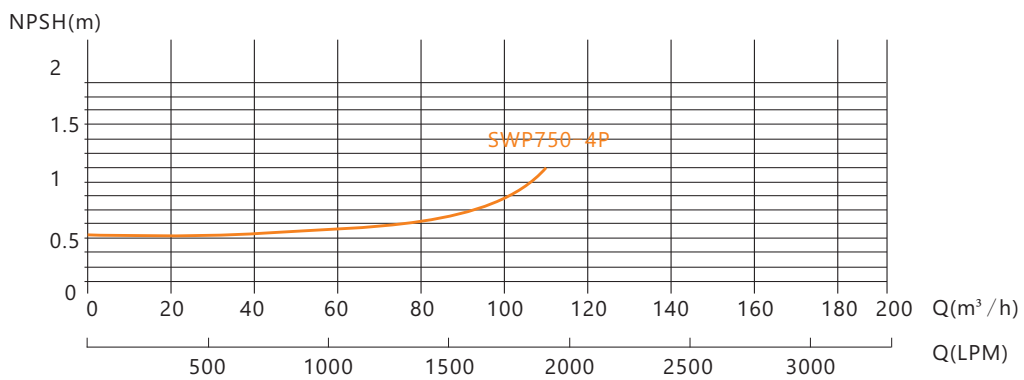
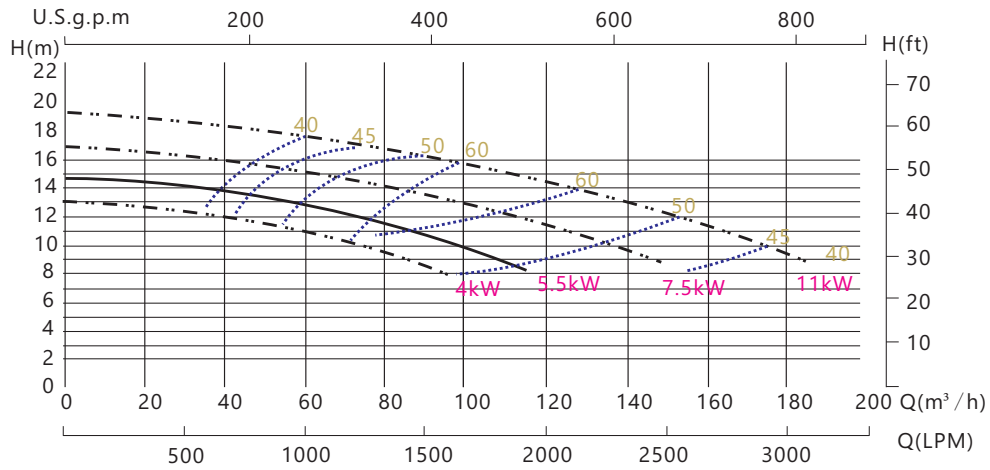

SWP1000-4P

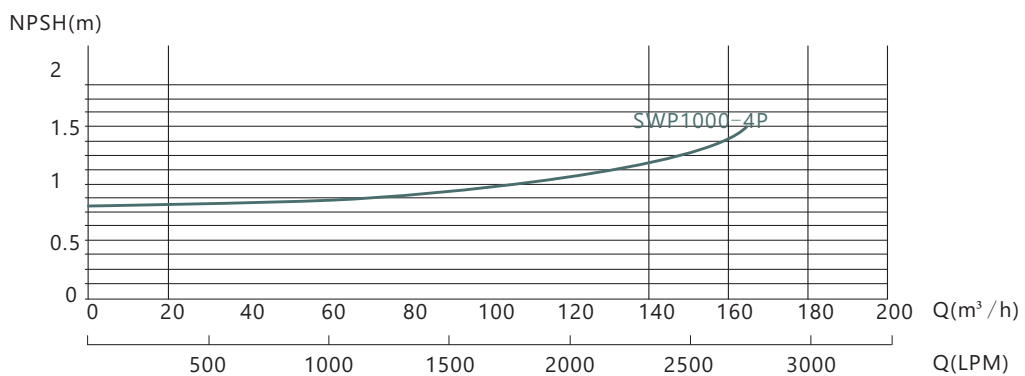
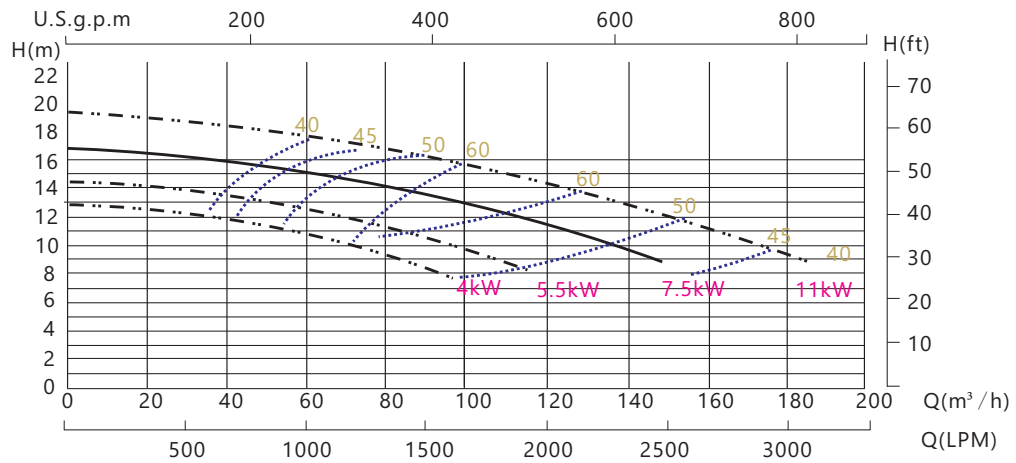

SWP1500-4P

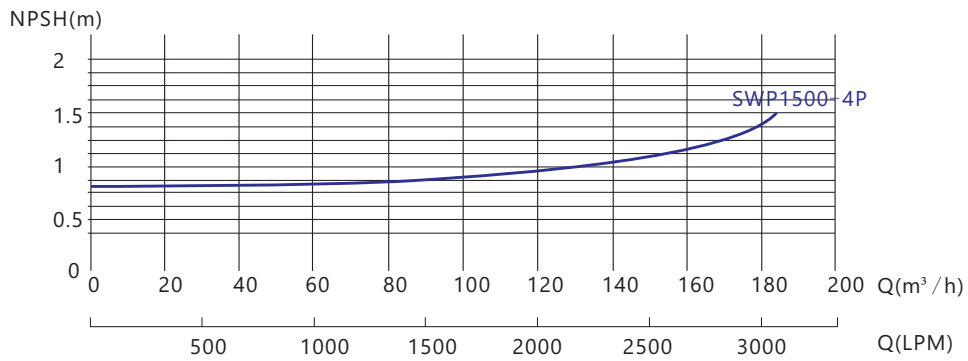
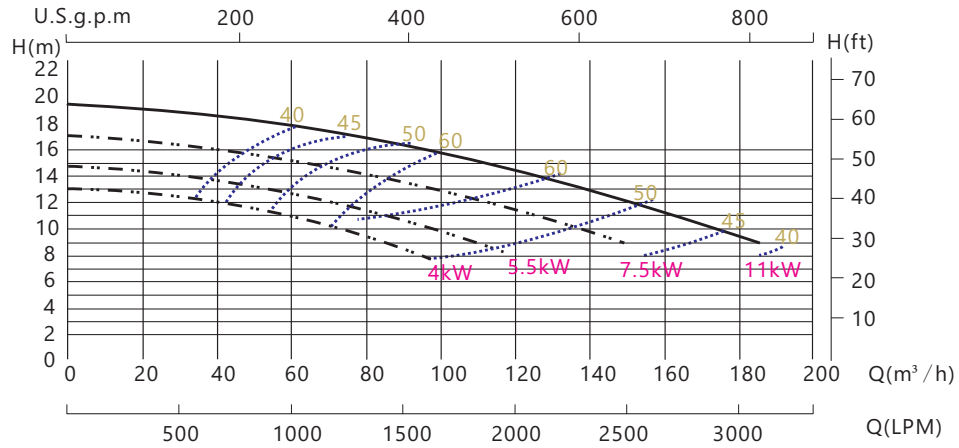

SWP2000-4P

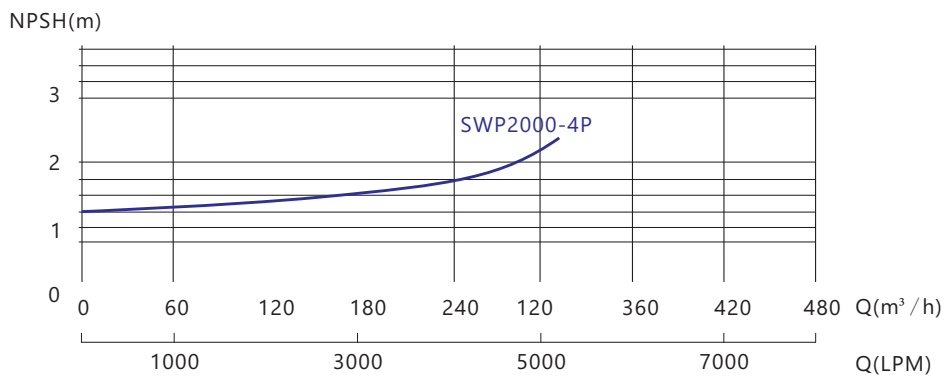
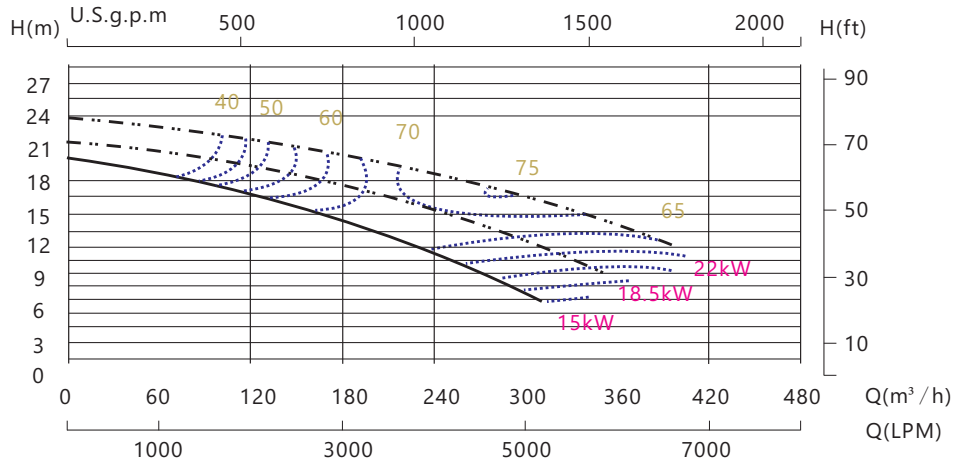

SWP2500-4P

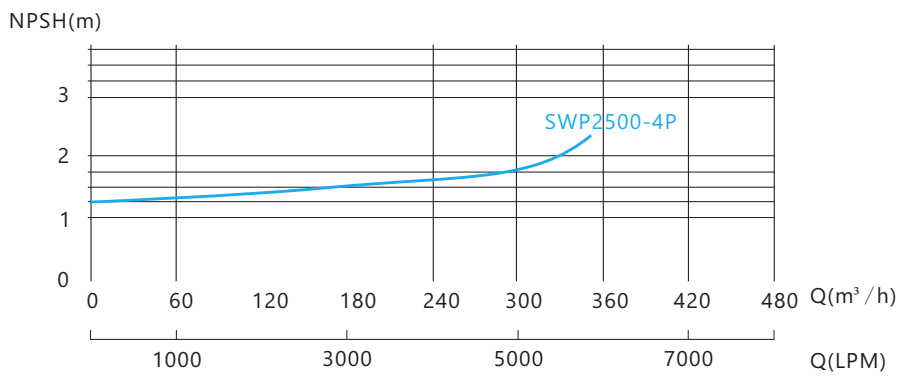
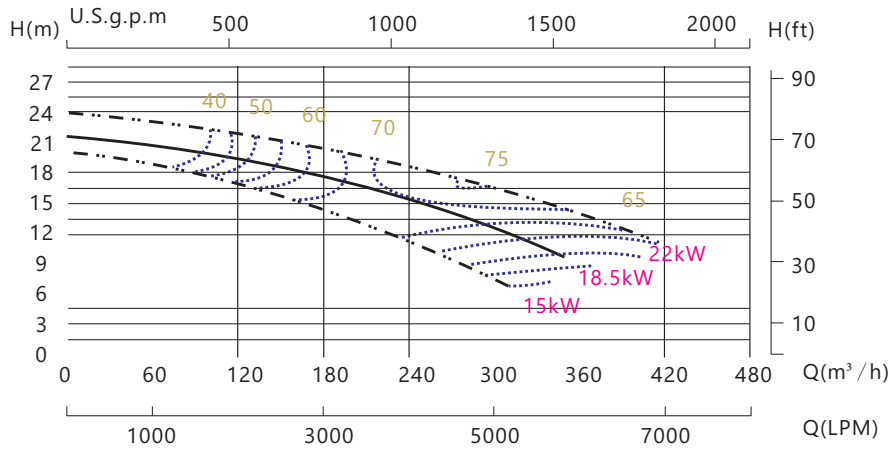

SWP3000-4P

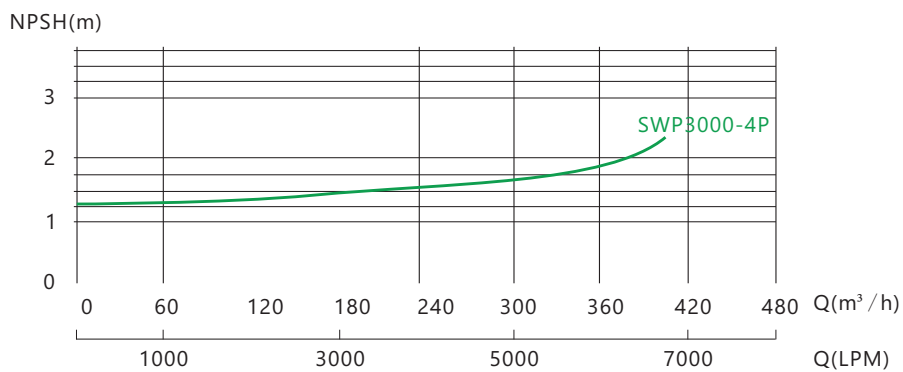
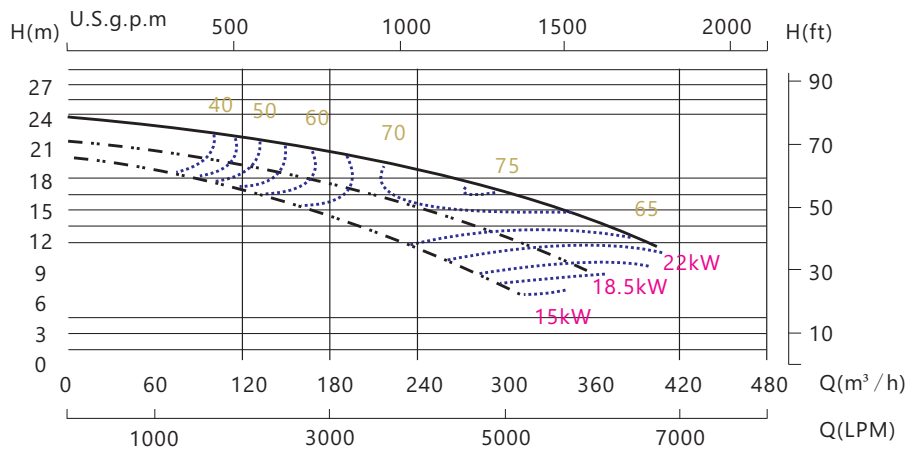

SWP4000-4P

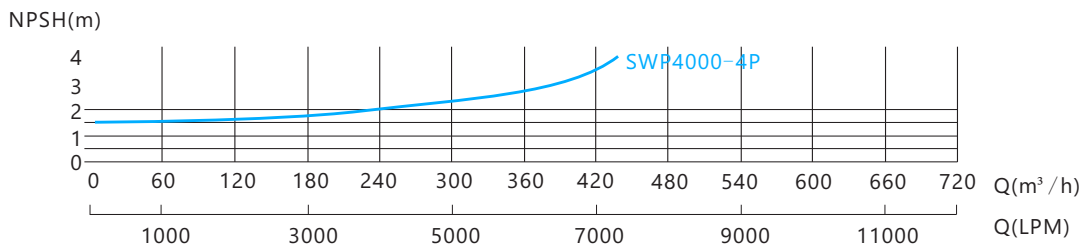
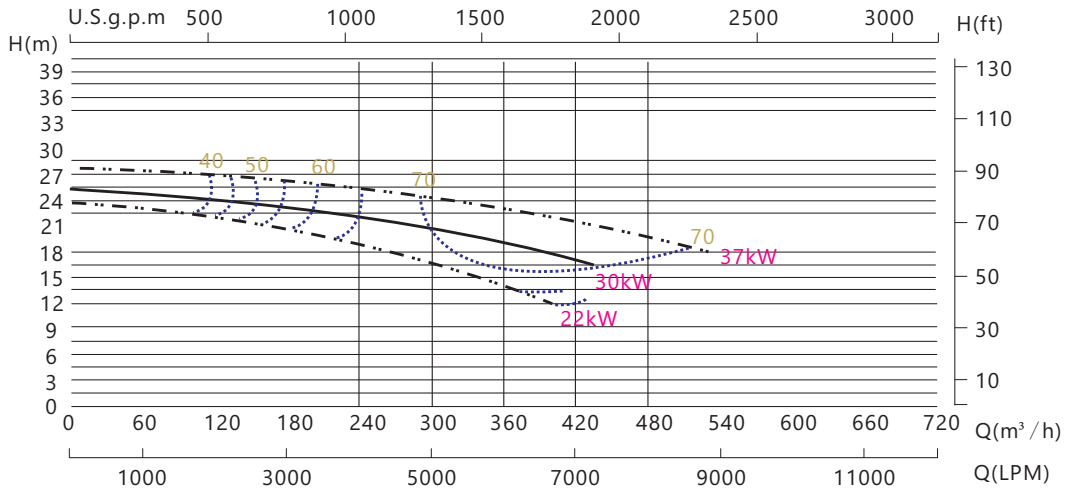

SWP5000-4P

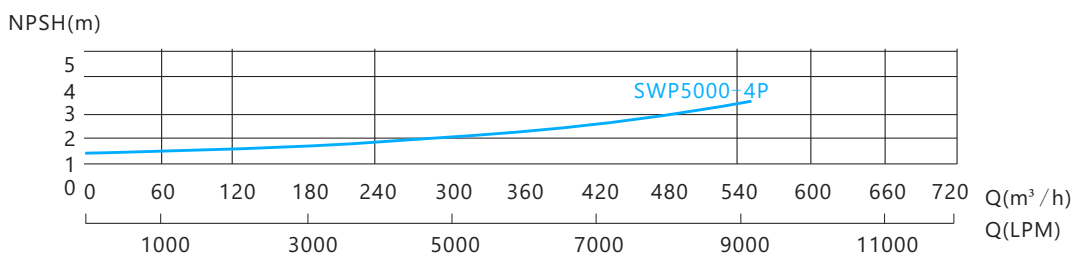
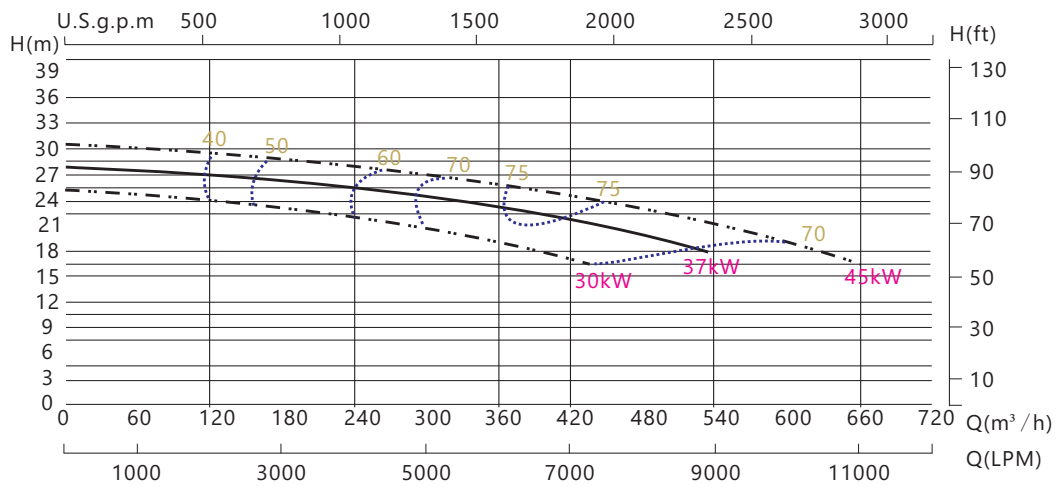

SWP6000-4P

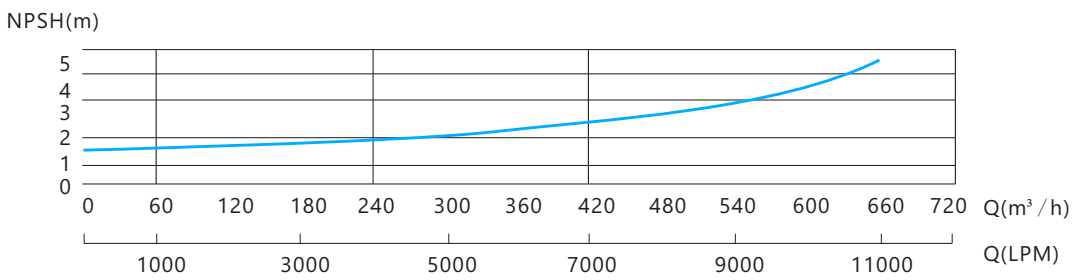
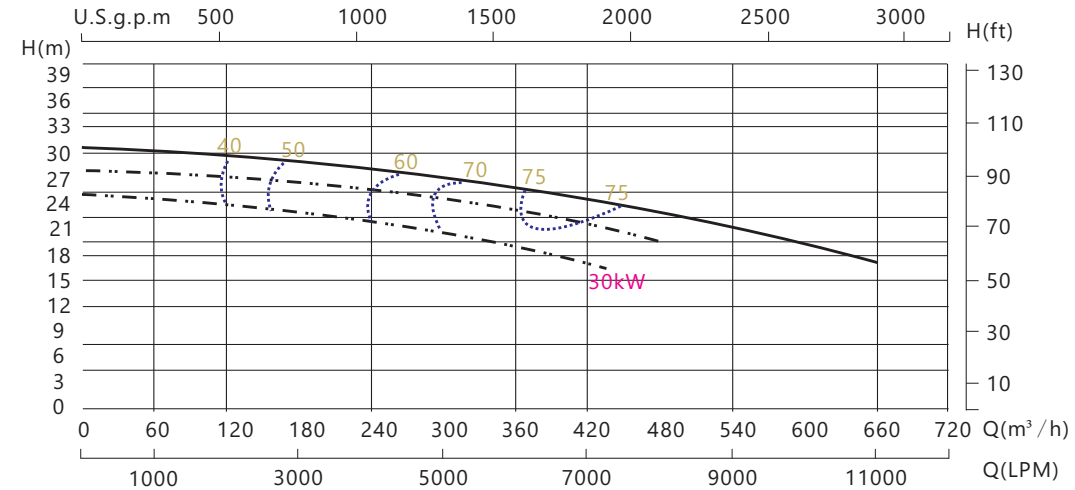

SWP1000-2P

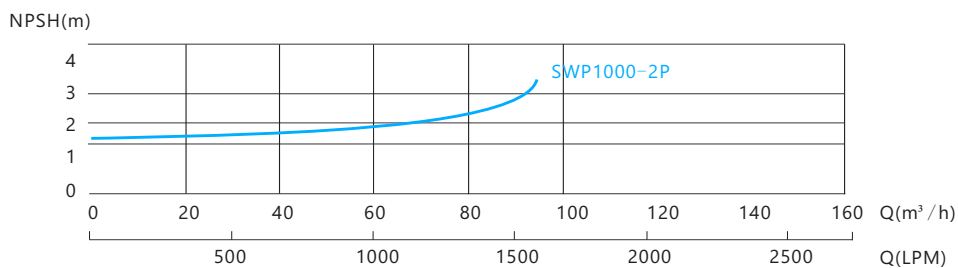
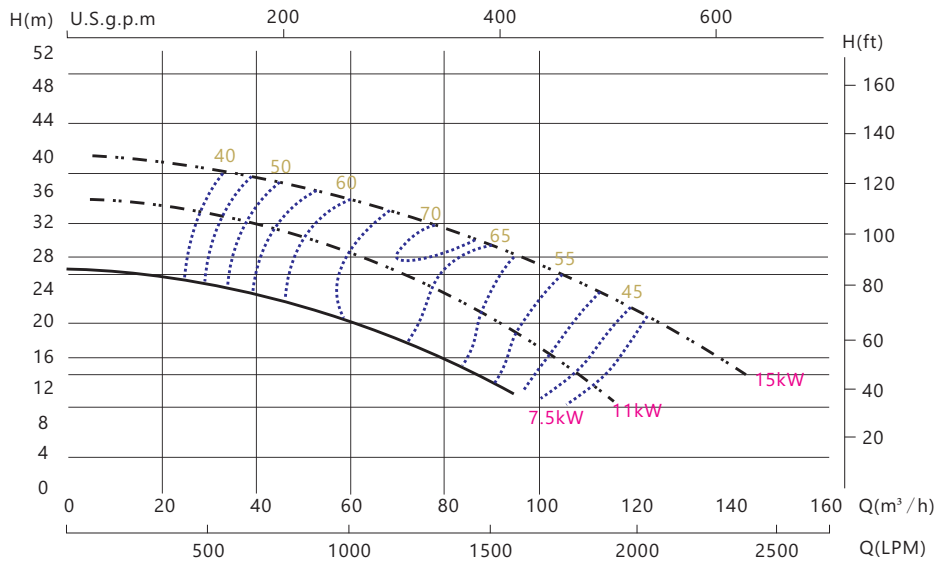

SWP1500-2P

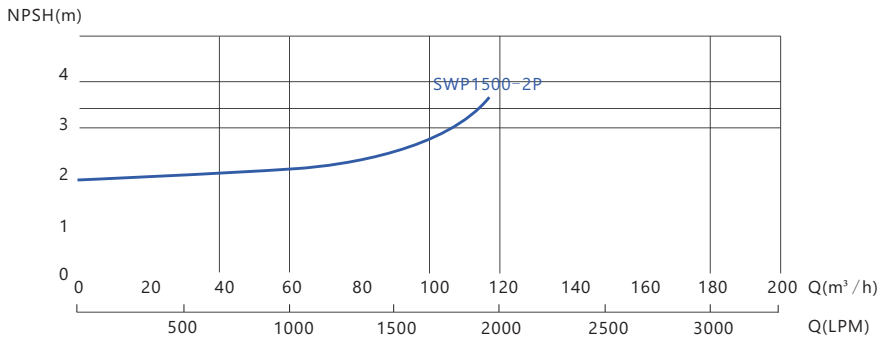
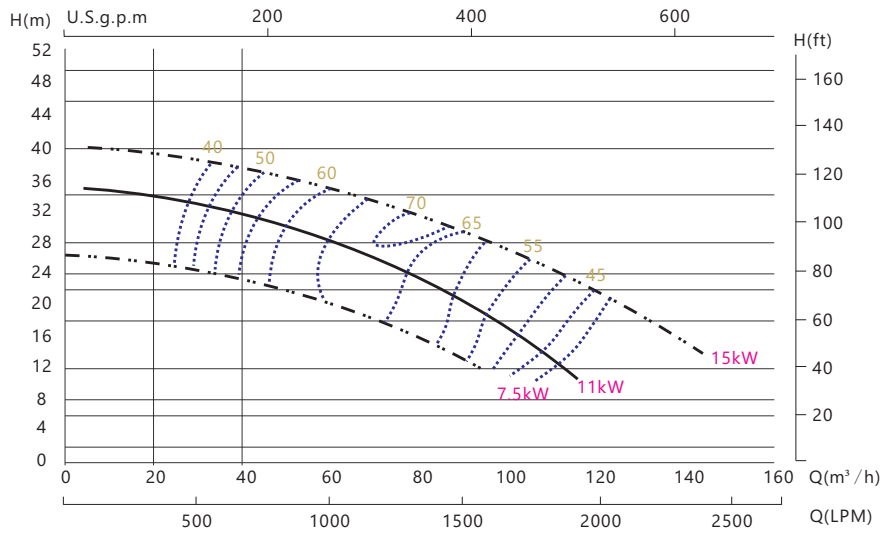

SWP2000-2P

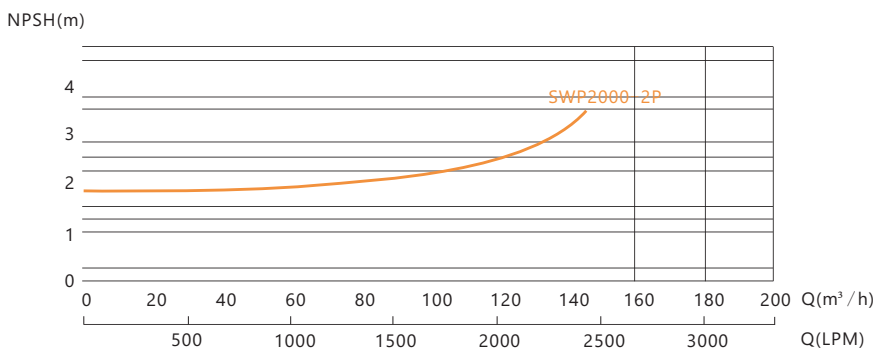
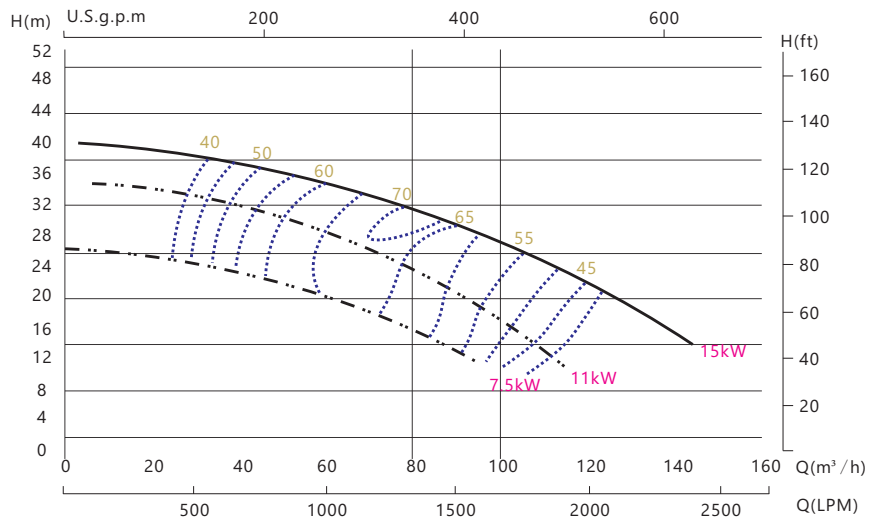

SWP2500-2P

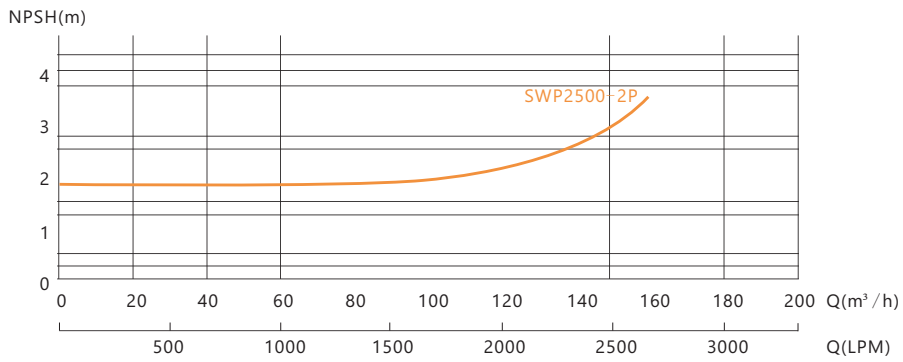
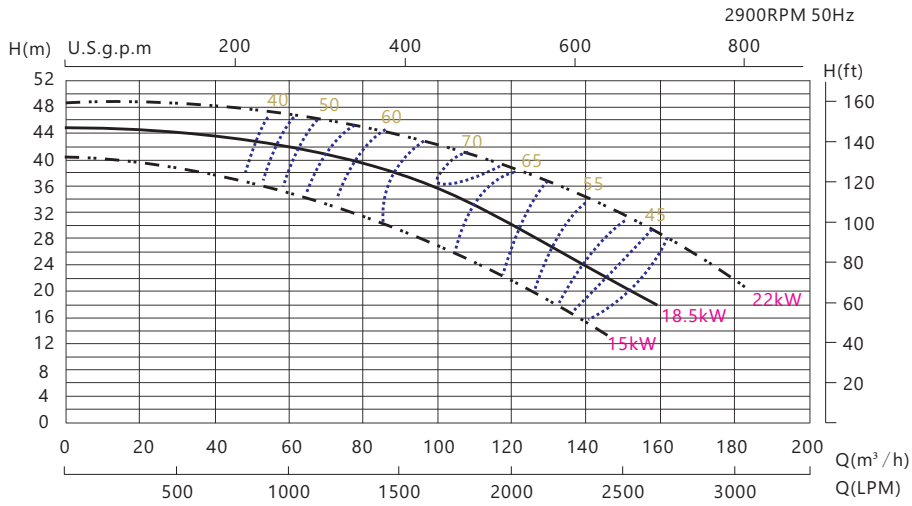

SWP3000-2P

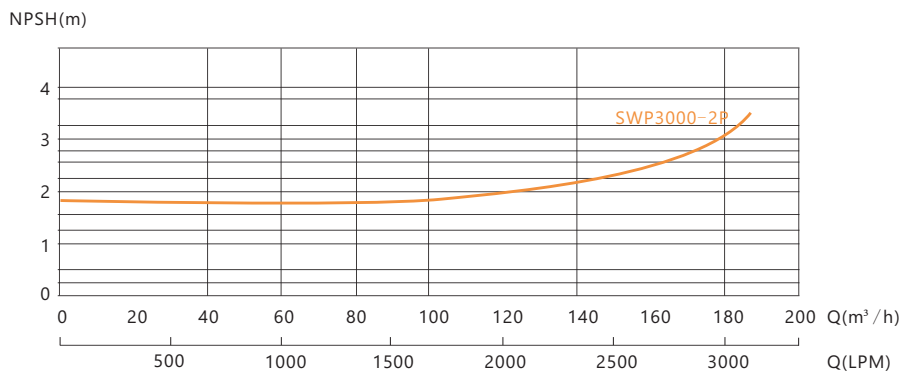
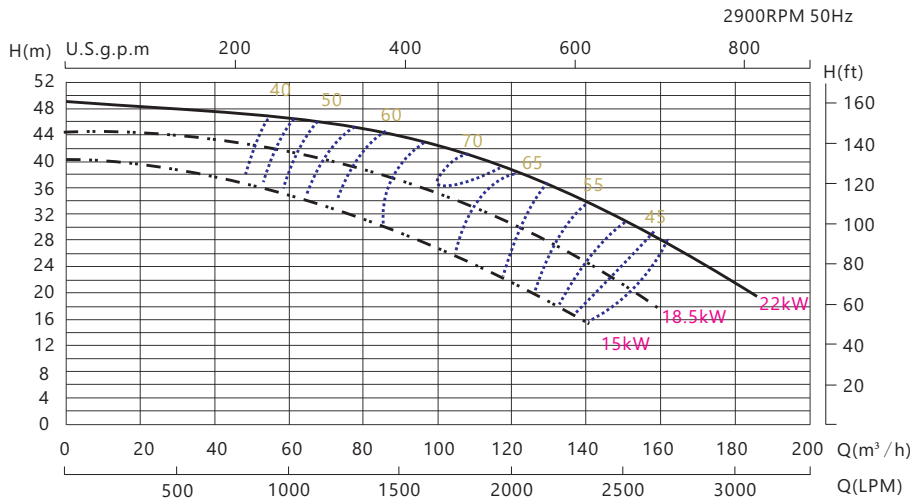

3. TRANSPORTATION AND STORAGE

3.1 PACKAGING

The packaging material is determined by the shape, size and weight of the product

Clients should follow the following steps when receiving the goods:

On receipt of the shipment, please remove the packaging carefully and check for transport damage and that the contents comply with the order and shipping list.

3.2 TRANSPORTATION, LOADING AND UNLOADING, RAISING

The product should be protected carefully during transportation and the shape, weight and the nature of package should be taken into consideration during loading and unloading.

When lifting the goods, the most vulnerable parts of the water pump (for example parts made by glass fiber and connecting parts etc.) should not be subjected to additional pressure. The packed water pump should be put down slowly avoiding any bumps and knocks. The water pump should be fitted in its normal position with sufficient support to keep it in place while being unpacked. Severe vibrations should be avoided during transportation.

The same care should be exercised when unloading the product.

When transporting, loading and unloading:

1. Check the weight, size and the center of gravity before loading and unloading
2. If the water pump needs to be moved after it has been installed, please ensure that the water in the water pump has been drained out;
3. Suspending and lifting the pump must only be done from the designated lifting points.
4. The lifting sling should not form an angle greater than 90 degrees.
5. The parts must not be lifted by a single hanger.
6. The handle of the motor must not be used for lifting.

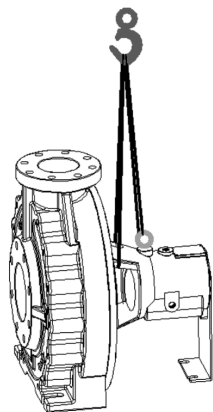

The installation and hanging diagram of the front part of the sea water pump

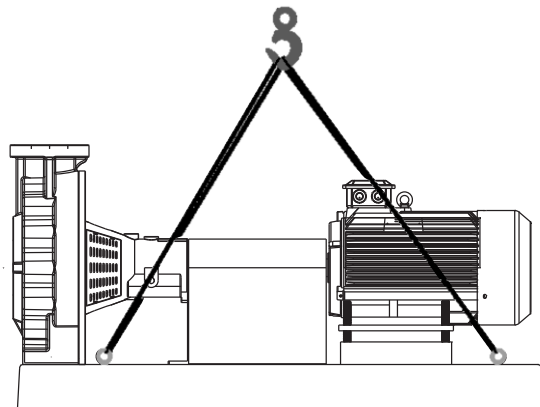

Hanging diagram of sea water pump

3.3 TESTING

1. The goods should be checked when they arrive.
2. The manufacturer is not responsible for any transportation damage.
3. Any transportation damage must be notified to the logistics company.

3.4 STORAGE

Separate parts of the water pump should be assembled in a short time. If the parts need to be stored for a longer time, they should be kept in a clean, dry space free of vibration, radioactive sources, flammable or explosive materials, and away from direct sunlight or other heat sources. Damages to the parts should be avoided before assembly.

During storage, the following points should be observed:

1. The parts of the water pump should be kept together with their original package. If the parts of the water pump need to be stored outside, the packages should be waterproof to avoid the permeation of dampness.
2. The parts of the water pump should be placed horizontally and should be covered with waterproof material.
3. The parts of the water pump should be placed on a pallet to avoid the direct contact with the ground or floor, and kept away from pollutants and corrosive elements, and to avoid deformation or bending.
4. Heavy items must not be placed on the packed parts.
5. The storage temperature should be between 5°C to 35°C and always above freezing point.
6. During storage, the shaft head should be rotated 5 times per week, paying attention to the normal direction of a pump in operation. This measure can effectively prevent the interface from locking under the function of friction force;
7. The port at the end of the water pump must not be removed if the the water pump has not been prepared for installation.
8. The water pump should be cleaned before installation in order to prevent external parts from affecting the normal running of the pump.

4. INSTALLATION



WARNING:

Please read this part carefully before installation. Deviating from these instructions could result in irreversible damage to the pump.

4.1 POSITION THE PUMP TO ENSURE THAT:



WARNING:

1. The water inlet and outlet pipes can be connected easily
2. The pump can be easily inspected while running;
3. The pump is close to the tank.

When installing the pump, ensure there is adequate distance to ensure the safety of persons nearby. The position of the pump should also consider possible leakage or damage to high voltage parts.

Before installation ensure that the electricity supply is disconnected and switched off and disconnected

4.2 SUPPORTING BASE

The base is manufactured in a material designed to provide adequate, solid support.

A solid level reinforced concrete base or floor should be available. The base should have an area larger than the base of the pump.

The pump base should be firmly fixed to the concrete using expanding bolts.

The supporting base is made by proper material to ensure that it can support the water pump and perimeter zone solidly. There are also suggested methods of laying foundations in cement. The base should be placed horizontally, tested with an air level, and fixed with standard screws. It is suggested to use metal gasket to avoid the problem of non-alignment between the water pump and the pipes, the using of which can make adjustments and ensure the alignment.

4.3 BASE AND FOUNDATION

The foundation should use proper material to ensure the solidity of the base and its perimeter zone. We highly recommend using reinforced concrete as the materials of the foundation. The surface of the foundations should be kept horizontal to ensure the exact fitness between the assembling unit and the pipes. Explosive screws should be used to fix the base and the foundation.

Note: The area of the foundation should be larger than the area of the base of the water pump

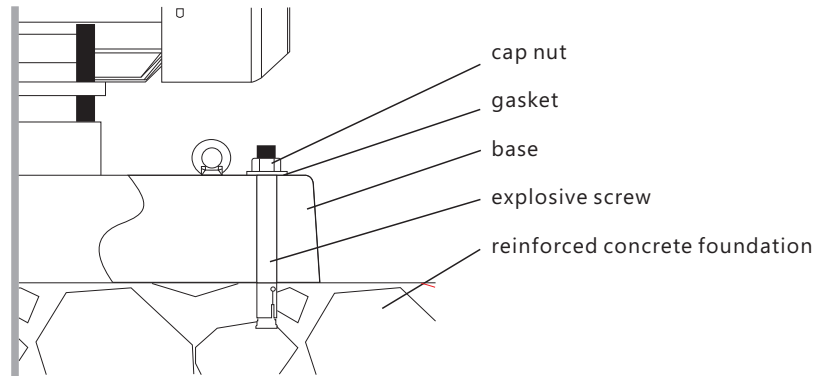

4.4 DRAINING PIPES ON THE BASE

A threaded hole is provided in the base to connect a drainage pipe that can evacuate any spillage or leakage onto the drip tray.

Note:

1. Drain pipes and fittings should be of the same material and use screw threads.
2. During operation of the pump the valve, if installed, should be open.

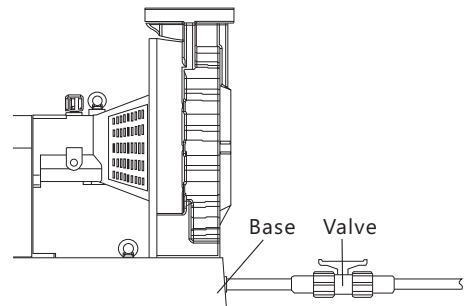

4.5 ALIGNMENT

The pump shaft and coupling are calibrated by the manufacturer during assembly. However the parts of the pump may become misaligned during transport. Alignment should therefore be accurately checked after installation and before operating the pump for the first time.

Turn the shaft by hand and check the alignment every quarter turn either electronically or by using a vernier caliper.

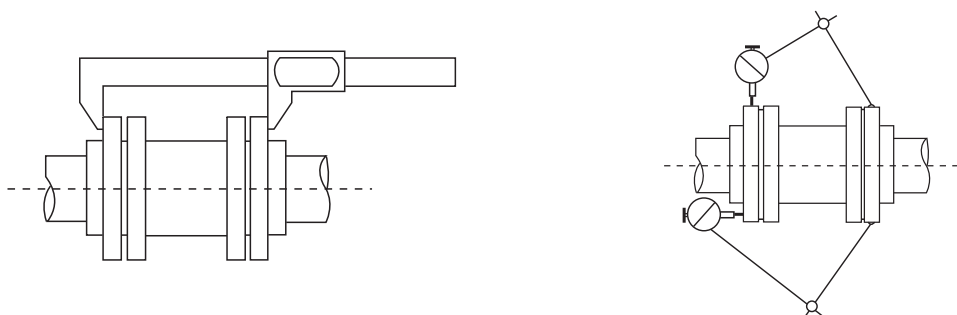

If the shaft is found to be misaligned, use the adjustment system on the base to realign the shaft.

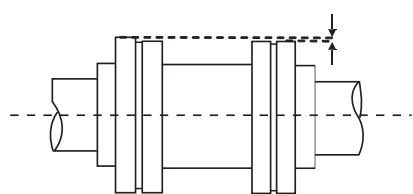

$\Delta Kr \text{ max} = 0.5\text{mm}$

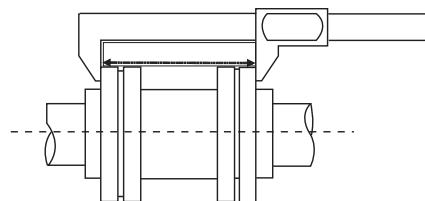

$\Delta Ka \text{ max} = 0.5\text{mm}$

4.6 PIPES

The performance of the pump depends directly on the design of the piping system. The size of the suction tank and the diameters of the inlet and outlet pipes should all be taken into consideration.

4.7 WATER INLET PIPE

The size of the water inlet pipe is very important. Improper size will result in many problems on the running of the water pump.

The following rules should be complied with:

1. The water inlet pipe should be short with as few bends as possible.
2. The pipes should be supported on racks which should be protected from corrosion.
3. When the inlet pipe is larger than the pump inlet, use a flexible connection.
4. The condition of the inlet pipe determines the maximum suction height. The viscosity and temperature of the liquid should also be taken into consideration.
5. Elbow pipes create significant reduction in flow. Use large radius bends wherever possible.
6. High level pipes that cause bubbles should be avoided.
7. Valves should only be installed in the system to prevent overflowing. Valves should always be fully open when the pump is running.
8. Air should be prevented from entering the pipes at the connections.
9. A filter should be installed near the pump inlet to prevent foreign matter from entering the pump (see below). The filter should be regularly inspected and cleaned.
10. The supply tank should be kept full at all times.
11. The foot valve in the tank should be installed at least 0.5 meters above the floor of the tank to prevent solid matter on the floor of the tank from being drawn into the pump.
12. A baffle plate should be installed in the tank to prevent the suction from creating a vortex.
13. An electromagnetic valve should be installed in the feed to the tank in order to maintain a minimum volume of liquid in the tank.

4.8 OPTIONAL PRE-FILTER

An MER series Commercial Basket Strainer (Pre-Filter) is available for installation with the SWP FRP Series pumps. The large volume heavy duty PVC basket will filter relatively large solid impurities to protect the pump, meters and valves from damage.

Code	Model	Diameter A (mm)	Length B (mm)	Height C (mm)	Diameter D (mm)	Length E (mm)	Length F (mm)	Inlet Flange N1 GB (mm)	Outlet Flange N2 GB (mm)	Capacity (m ³ /h)
9210414	MER100-100S	445	830	851	360	310	523	100	100	58
9210413	MER150-100S	565	965	981	440	310	593	150	100	123
9210412	MER200-150S	565	985	1113	440	354	705	200	150	192
9210411	MER250-200S	615	990	1260	490	468	837	250	200	301
9210410	MER300-200S	615	990	1260	490	468	837	300	200	447

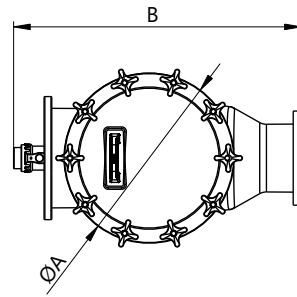
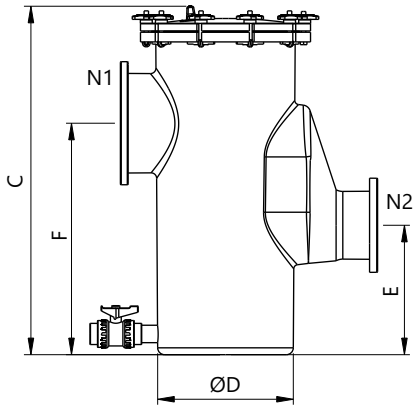

4.9 INSTALLATION EXAMPLE WITH PRE-FILTER

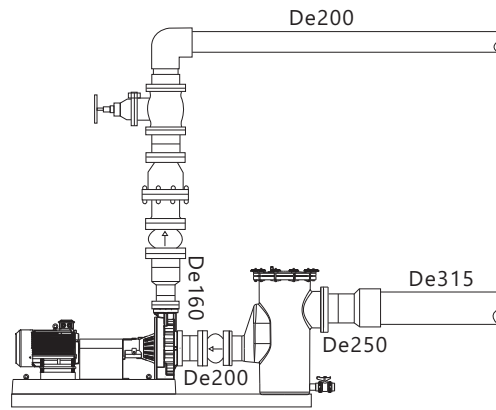

SWP2500-4P flow Rate 180m³ /h

4.10 FLANGE INSTALLATION

The suction inlet and discharge outlet of pump body are in DIN (PN10) standards with hex nut insert into the pump body.

1. Place the 8 large bolts from the pipe flange side to the pump body face.
2. Put a 3.2mm thickness gasket in between.
3. Push the bolts to the pump body face flange hole.
4. Keep the bolt straight and lightly snug each bolt with a wrench one by one until a squealing sound is heard to indicate that the bolts are being excessively tightened.

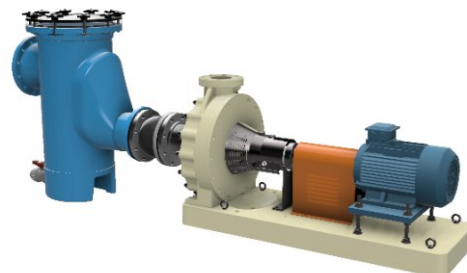

5. ELECTRICAL WIRING



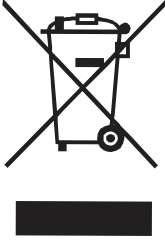







1. A protective device is to be installed in the fixed wiring.
2. This appliance can be used by children aged from 8 years and above and persons with reduced physical, sensory or mental capabilities or lack of experience and knowledge if they have been given supervision or instruction concerning use of the appliance in a safe way and understand the hazards involved. Children shall not play with the appliance. Cleaning and user maintenance shall not be made by children without supervision.
3. The appliance shall be installed in accordance with national wiring regulations means for disconnection must be incorporated in the fixed wiring in accordance with the wiring rules. A disconnected incorporated in the fixed wiring is to be provided.
4. The pump is to be supplied through a residual current device (RCD) or Ground Fault Circuit Interrupt (GFCI) having a rated residual operation current not exceeding 30mA.

Correct disposal of this product	
	<p>This symbol on the product, or in its packaging, indicates that this product may not be treated as household waste. Instead, it should be taken to the appropriate waste collection point for the recycling of electrical and electronic equipment. By ensuring this product is disposed of correctly, you will help prevent potential negative consequences for the environment and human health, which could otherwise be caused by the inappropriate waste handling of this product. For more detailed information about the recycling of this product, please contact your local council, your household waste disposal service, or the shop where you purchased the product.</p>

5.1 ELECTRICAL WIRING - 3 PHASE

SWP FRP pump motors operate on 3 phase power. The latest cable color code is Brown for L1, Black for L2, Grey for L3, Blue for Neutral and Green & Yellow for Earth/Ground.

The previous code was Red for L1, Yellow for L2, Blue for L3, Black for Neutral and Green & Yellow for Earth/Ground.

3 phase Cable New Wire Color Code		3 phase Cable Old Wire Color Code	
L/L1	 Brown	L/L1	 Red
L2	 Black	L2	 Yellow
L3	 Grey	L3	 Blue
N	 Blue	N	 Black
Earth	 Green & Yellow	Earth	 Green & Yellow

5.2 DIRECT ON LINE STARTER



WARNING:

Direct On Line (DOL) starter is the simplest, cheapest and most common starting method. It actually gives the lowest temperature rise within the motor during startup of all the starting methods. But the drawback is starting current can be 3-8 time of full load current. Therefore, it is not recommend for pump power higher than 5.5KW in public low voltage mains 400V.

The typical common 3 phase pump Run / Stop starter is Direct-On-Line Starter that include:

1. Motor Circuit Breaker is a short circuit magnetic protection devices.
2. Control unit for Run and Stop operation and status monitoring.
3. Protection relay is an overload thermal protection device.
4. Single phase MCB for secondary protection.

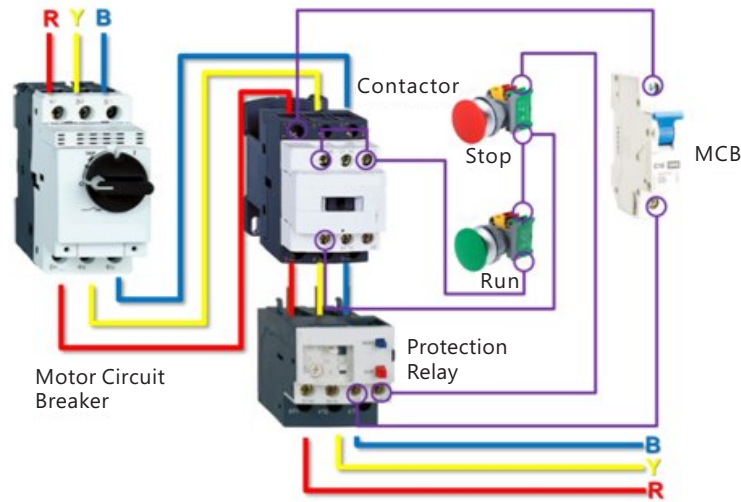

Direct-On-Line (DOL) Starter typical wiring.

DOL Starter can be applied to motor connect in Delta or WYE/Star connection.



WARNING:

The electrical connection must be installed by a qualified electrician or pool technician to ensure that adequate protection is provided between the pump motor and mains power supply in accordance with national electricity safety codes.



Low Voltage Delta Connection



High Voltage WYE / STAR Connection



Motor Rotation Direction

Reversing the phase sequence can change the direction of rotation.

1. Each power supply line must be protected by an overload circuit breaker to isolate the mains power and provide protection to motor.
2. A 3-Phase starter switch or magnetic switch must be installed for switching the pump on and off.
3. The motor runs counter clockwise when viewed from the front of the motor. A rotation arrow on the pump body to show the correct direction. Turn on the pump for one second to check for correct rotation direction. If any two cables are interchanged. The pump will rotate in the wrong direction.
4. In countries where electricity supplies are governed by the International Electrotechnical Commission (IEC) standards, the power lines must be connected through a residual current device (RCD, GFCI) having a rated tripping current not exceeding 30mA.

5.3 STAR-DELTA STARTER

Star-Delta Starter has to be used for high power rating pump. It is used for large motor size with high starting current surge.

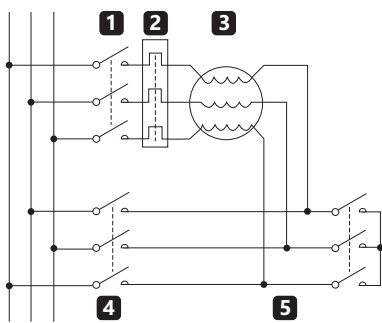

1. Main Contactor
2. Thermal overload
3. Motor (3 phase)
4. Delta contactor
5. Star Contactor

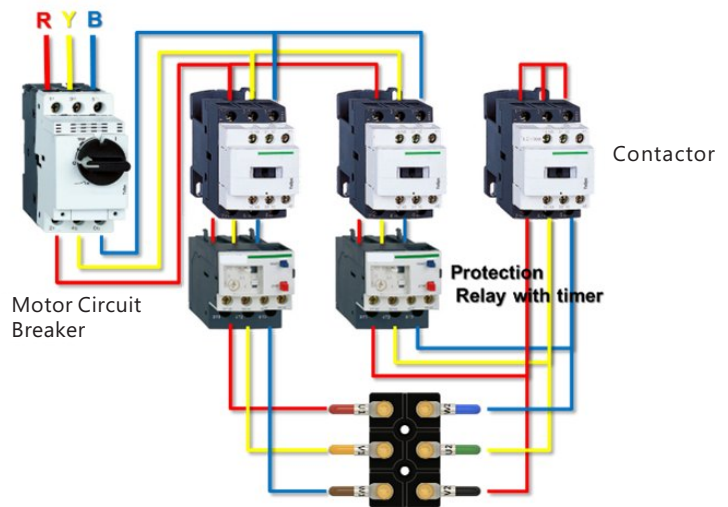

The contact plate on the six terminals has to be removed.

5.4 VARIABLE FREQUENCY DRIVE (VFD)

The pump can be supplied through a Variable Frequency Drive (VFD) for better starting and energy saving. The connection is straightforward: the 3 phase operation voltage output of the VFD should be connected to the pump in Delta or Star configuration according to the rating plate on the motor.





WARNING:

Besides current and power rating, the VFD is the key parameter to drive the motor, the EMC filter between VFD and motor is important to prevent the motor bearing, shaft and mechanical seal from being damaged by harmonic noise created by the VFD inverter output. It is necessary to consult your VFD supplier to optimize the EMC filter. Some VFD supplier have a built-in EMC filter. If not, it is necessary to consult the VFD supplier and add an EMC filter module between VFD and Motor.



For high power pumps, it must add a large current EMC filter should be installed such as du/dt filters. Consult your VSF supplier for the best match.

5.5 SOFT STARTER

A soft motor starting system is also possible. A single-phase, 2-phase or 3-phase input can be connected direct to the motor terminals. It can setup initial voltage and ramp up to full power smoothly to prevent current surge; and stop the pump slowly which helps eliminate water hammer.

The key benefits of soft start

1. Smooth acceleration without the torque transients associated with electro-mechanical reduced voltage starters.
 2. Voltage or current is applied gradually, without the voltage and current transients associated with electro-mechanical reduced voltage starters.
 3. Lower start current sand / or shorter start times because constant current control gives higher torque as motor speed in creases.
 4. Easy adjustment of start performance to suit the specific motor and load.
 5. Precise control over the current limit.
 6. Consistent performance even with frequent starts.
 7. Reliable performance even if load characteristics vary between starts (eg loaded or unloaded starts).
- It is necessary to refer to the soft starter manufacturer for detail starting conduction setting.



5.6 MOTOR CURRENT RATING ESTIMATION

Table of Motor current rating estimation for reference if there is no current rating on the motor plate.

Motor Power		Current rating at different voltages					
kW	HP	220-230 V	380-400 V	440 V	460 V	500 V	660-690 V
7.5	10	27	16	14	13	12	9
11	15	39	22	20	18	18	14
15	20	52	30	27	25	23	17
18.5	25	64	37	33	30	29	21
22	30	75	44	39	35	33	25
25	35	85	52	45	38	39	30
30	40	103	60	52	48	45	35
37	50	126	72	64	59	55	42
45	60	150	85	76	73	65	49

5.7 MOTOR SPECIFICATION

IP 55 - IC 411 - Insulation class F, temperature rise class B
IE3 efficiency class according to IEC 60034-30-1; 2014

Model	Terminal Box	Power kW	RPM	Efficiency IEC 60034-30-1; 2014			Power Factor Cos φ	Current		Torque			Moment of inertia J = 1/4 GD ² kgm ²	Weight kg	pressure Level LPA dB
				100% full load	75% Load	50% Load		In A	Is/In	Tn Nm	Ti/Tn	Tb/Tn			
SWP1000-2P	05	7.5	2901	90.1	90.1	91.2	0.91	13.1	7.3	24.72	2.2	3.7	0.02	83	71
SWP1500-2P	06	11	2943	91.2	92.0	91.6	0.91	19.1	7.2	35.57	2.6	3.6	0.057	121	69
SWP2000-2P	06	15	2947	91.9	92.2	91.8	0.88	26.5	8.2	48.49	3.2	4.2	0.063	128	69
SWP2500-2P	06	18.5	2949	92.4	93.0	92.6	0.90	32.0	9.0	59.81	3.3	3.9	0.076	145	73
SWP3000-2P	06	22	2941	92.7	93.0	92.7	0.84	41.1	8.7	71.42	3.4	4.1	0.073	152	70
SWP550-4P	05	4	1443	88.6	88.9	88.1	0.81	8.11	9.4	26.53	3.6	4.4	0.0152	50	57
SWP750-4P	05	5.5	1463	89.6	90.4	90.2	0.77	11.5	7.9	35.89	2.6	3.3	0.0297	67	68
SWP1000-4P	05	7.5	1465	90.4	90.7	90.3	0.78	15.5	7.4	48.96	2.5	4.0	0.037	77	60
SWP1500-4P	06	11	1477	91.4	91.8	91.1	0.82	21.1	7.6	71.27	2.6	3.3	0.11	136	61
SWP2000-4P	06	15	1477	92.1	92.4	91.6	0.82	28.5	8.2	96.99	3.0	3.7	0.135	161	61
SWP2500-4P	06	18.5	1472	92.6	92.6	92.0	0.82	35.0	10.3	120.1	3.6	4.0	0.135	169	64
SWP3000-4P	06	22	1473	93.0	93.2	92.5	0.80	42.8	10.1	142.58	3.3	4.2	0.167	198	65
SWP4000-4P	07	30	1481	93.6	94.0	93.5	0.82	56.3	10.0	192.76	3.9	3.0	0.32	282	69
SWP5000-4P	07	37	1479	93.9	94.2	93.7	0.81	70.3	9.3	237.79	2.5	3.0	0.376	278	67
SWP6000-4P	07	45	1481	94.2	94.4	93.8	0.79	87.8	9.1	288.31	4.2	3.6	0.415	293	68
SWP550-6P	05	4	972	86.8	86.8	84.9	0.65	10.1	7.0	39.32	2.7	3.6	0.0343	71	52
SWP750-6P	05	5.5	974	88.0	87.4	86.0	0.67	13.5	7.3	54.2	2.9	3.5	0.0511	97	65
SWP1000-6P	06	7.5	979	89.1	89.5	88.9	0.75	15.9	7.6	73.39	1.8	3.1	0.099	131	59
SWP1500-6P	06	11	976	90.3	91.3	91.3	0.78	22.5	7.8	107.71	1.9	3.0	0.134	161	57
SWP6000-6P	08	45	991	93.7	94.0	93.5	0.84	81.9	7.4	433	2.7	3.0	1.87	562	72

TEMPERATURE RISE CONSIDERATION

The impact on temperature rise caused by voltage and frequency fluctuation is defined in IEC 60034-1. The standard divides the combinations into two zones A and Zone B.

1. Zone A is the combination of voltage deviation of +/-5 % and frequency deviation of +/- 2 %.
2. Zone B is the combination of voltage deviation of +/-10 % and frequency deviation of +3/-5 %.

Motors are capable of supplying the rated torque in both zones A and Zone B, but the temperature rise will be higher than at rated voltage and frequency. Motors can be run in zone B only for a short period of time.

ABB		IE3		60000L-F	
3-Phase		P1MAX 28050C 4 3003/31001		2024	
30246L-F					
No. 30246L-F001204	Ins. cl. F		IP 55		
V	f _{Hz}	kW	r/min	A	1000 W Duty
690 Y	50	7.5	1485	17	S1
400 D	50	7.5	1485	17.9	S1
440 Y	50	7.5	1483	16	S1
380 D	50	7.5	1483	16.8	S1
440 D	50	7.5	1786	14.4	S1
440 D	50	7.5	1786	15.9	S1
IE3-S1000-05 2700001-95 4105001-05 3005001 / 0 3.5000 95 4100001					
Product code 308428230-A308					
6211/03 6211/03 6211/03					

MOTOR RATING PLATE

690 Y means 690V 50Hz @ 1485 RPM in Star Connection.

400 D means 400V 50Hz @ 1485 RPM in Delta Connection.

It can be 440V 60Hz @ 1786 RPM in Delta Connection too.

Refer to the previous Star and Delta configuration on the terminal box.

MOTOR RATING PLATE

690 Y means 690V 50Hz @ 1485 RPM in Star Connection.

400 D means 400V 50Hz @ 1485 RPM in Delta Connection.

It can be 440V 60Hz @ 1786 RPM in Delta Connection too.

Refer to the previous Star and Delta configuration on the terminal box.

TERMINAL BOX



6. START UP

Service personnel should be equipped with appropriate tools for the operations described in this section. Rubber shoes, acid-proof protective clothing and a helmet with face protection can ensure the operator's safety. Some parts in the water pump rotate at a very high speed. The following operations should be done by experienced operators.

6.1 ROTATING DIRECTION

The rotating direction should be checked before starting the water pump. The direction should be marked permanently on the water pump, clockwise from motor to pump body. The following steps should be followed when checking the motor rotating direction.

1. Turn the switch off
2. Disconnect the power line
3. Remove the coupling protective cover
4. Remove the coupling spacer
5. Replace the coupling protective cover again
6. Connect the power line
7. Turn the switch on to start the motor
8. Observe the rotating direction to see whether it is the same as the rotating direction on the water pump
9. If the rotating direction is wrong, exchange the phase of the motor (doing this step after turning the switch off);
10. If the rotation direction is correct, re-install the coupling spacer and then start the motor.

6.1 ROTATING DIRECTION

The rotating direction should be checked before starting the water pump. The direction should be marked permanently on the water pump, clockwise from motor to pump body. The following steps should be followed when checking the motor rotating direction.

1. Turn the switch off
2. Disconnect the power line
3. Remove the coupling protective cover
4. Remove the coupling spacer
5. Replace the coupling protective cover again
6. Connect the power line
7. Turn the switch on to start the motor
8. Observe the rotating direction to see whether it is the same as the rotating direction on the water pump
9. If the rotating direction is wrong, exchange the phase of the motor (doing this step after turning the switch off);
10. If the rotation direction is correct, re-install the coupling spacer and then start the motor.

6.2 INITIAL TESTING OF THE WATER PUMP

Before starting the water pump, rotate the transmission shaft by hand from the position of the coupling to ensure that the shaft rotates normally in the right direction. When doing this, the power line should be disconnected from the electricity supply.

6.3 INITIAL TESTING OF THE MOTOR

Check all electronic connections and rotating directions before starting the motor.

6.4 STARTING

The following steps should be followed before starting the water pump:

1. Check that all bearings have been adequately lubricated
2. Check the rotating direction of the motor;
3. Check that the water inlet and discharge pipes and seals have been correctly connected and that all threaded bolts have been tightened
4. Fully open the valve in the water inlet pipe;
5. Check and clear all solid foreign matter in the water inlet pipe and pre-filter basket
6. Prime the pump and the inlet pipe with water
7. Switch on the power to the water pump
8. Slowly open the valve in the water outlet pipe (starting from 10%)
9. Adjust the working level of the water pump through the valve in the discharge pipe
10. Check the input value of the water pump and compare it with the values printed on the nameplate, ensure that the rating value is not exceeded.

The following points should be observed when the water pump is running:

1. Do not carry out any maintenance or checking parts of the pump
2. Do not carry out any maintenance or checking if the motor has not been disconnected from the power supply
3. Frequently monitor the temperature of the bearings
4. Prevent people or any objects contacting the hot parts of the water pump;
5. Ensure that the pump is free of vibration and the noise does not exceed the rated value;
6. Never run the water pump without water or with little water!
7. When the water outlet valve is turned off, do not run the pump for more than 1 minute.
8. The pump should be switched off immediately if bubbles form.

6.6 TEMPERATURE

The permitted working temperature of the pump is indicated in the data sheet. The working temperature of the pump may vary depending on the density or viscosity of the liquid.

6.7 THE WORKING TEMPERATURE OF THE BEARINGS

The temperature of the bearings should be measured regularly and be compared with the data provided by the manufacturer. By doing so, any change in the process of working can be found easily, including the loss and the imbalance of rotating parts. Adjustments should be done immediately if the environment does not comply with the standards of the pump, or if a system failure occurs.

Group	Temperature range of the bearings (2950-3500rpm)	Group	Temperature range of the bearings (1000-1750rpm)
4X3 6X4	55 – 75	4X3 6X4	55 – 70
8X6	55 – 80	8X6	55 – 75

The maximum working temperature of the bearings shouldn't exceed 110°C

6.8 FLOW RANGE

The manufacturer selects the type of the water pump, the impeller, and the motor power according to the data of flow and pump heads provided by clients. Clients should check the working condition indicated on the data sheet, especially the data of flow, pump head, and the liquid to be pumped.

6.9 NOISE VALUE

The normal working noise of the water pump will not generally exceed 80db. However, based on the motor power, location, and the material and structure of the pipes, the noise may exceed this value. Estimated noise values are indicated in the following table:

Motor's power (kW)	Noise value (dB)			Sound Pressure	Measures to be taken to solve the problem
	1000RPM	1450RPM	2900RPM		
4	62	63	69	Less than 70dB	No measures are needed
5.5	62	65	71	Greater than 70dB	Providing protective facilities to the staff near the water pump
7.5	64	66	72		
11	66	68	74	Greater than 90dB	Signs should warn the staff of noise in the area. Ear protection muffers should be worn Sound proof material should be used around the water pump to absorb the noise.
15	67	69	75		
18.5	68	70	76		

7. MAINTENANCE

Service personnel should be equipped with appropriate tools for the operations described in this section. Rubber shoes, acid-proof protective clothing and a helmet with face protection can ensure the operator's safety. Some parts in the water pump rotate at a very high speed. The following operations should be done by experienced operators.

7.1 PROPHYLACTIC MAINTENANCE

Check all kinds of value of the liquid pumped by the water pump (including temperature, proportion and chemical composition). Check flow and pressure value and compare them with designed value to ensure that there is no variation. Ensure that the controlling assembly works normally and correctly receives signals.

7.2 DAILY CHECKING AND MAINTENANCE

Daily monitoring of the running of the pump can find fault timely and measures can be taken to prevent it from affecting other parts of the system. The following checks should be carried out each time the water pump runs:

1. Check noise value, vibration, temperature and working status;
2. Check for leaks of liquid or lubricating oil;
3. Check the level of lubricating oil;
4. Ensure that the water pump is not running without liquid;
5. Check for seepage on the base (if it is provided). If seepage is present, open the valve to drain the seepage;
6. Ensure that all the threaded bolts of the pump have all been correctly tightened.

7.3 ADDITIONAL MAINTENANCE

If faults or leakage occur, stop the pump immediately and follow the trouble-shooting steps. The cause of the problem or the fault should become clear. If the problem cannot be identified, contact the manufacturer immediately. Without the manufacturer's approval, any operation to the water pumps is prohibited.

7.4 LUBRICATING OIL

It is essential to maintain the correct oil level. Insufficient lubricant will cause early wear of the bearings. Too much oil can overheat the bearing or cause the oil to leak. The first oil change should be made after 300 hours of operation, after which the oil should be changed every 4 months.

The oil level should be checked when the oil is close to room temperature

The lubricant oil should be clean and free of solid particles

The temperature of the operating environment of water pump should be taken into account.

Oil of different brands or different natures must not be mixed. (Lubricant oil: Mobil 600 XP 68 Grade ISO VG 68)

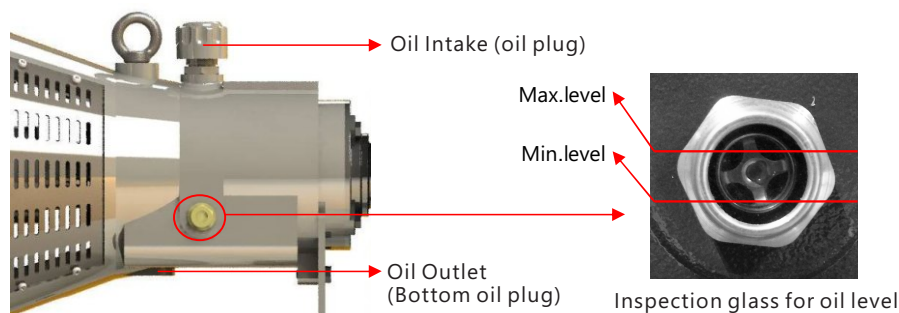

To add oil:

1. Unscrew the oil plug.
2. Pour in the required amount of oil.
3. Check that it does not exceed the maximum level or is lower than the minimum value
4. Tighten the oil plug.

To empty the oil:

5. Place a receptacle under the bottom oil plug.
6. Unscrew the bottom oil plug.
7. Wait until all oil has been discharged; clear excess.

7.5 FREEZING LIQUID IN THE PUMP

The risk of liquids freezing inside the pump should be understood. Users should be aware at what temperature and conditions the liquid in the pump will freeze. The manufacturer should be informed of any unusually low ambient temperatures, as frost damage will invalidate the warranty.

7.6 DRAINING AND CHANGING OF THE LIQUID IN WATER PUMP

If it is needed to use the water pump for a different liquid, the user should seek the advice of the manufacturer. Different viscosity will affect the performance and life of the pump or increase the load on the shaft, which will reduce the operating pressure.

To change the liquid in the pump:

1. Stop the pump
2. Completely empty the liquid in the pump (if there is a drainage port) and the inlet pipe
3. Thoroughly wash the inside of the pump with clean water or relative liquid taking care to avoid any damage to the equipment or harm to the operator from chemical reaction
4. Correctly dispose of the liquid used for washing.

7.7 IDLING RUNNING

The pump of this must not be run idly. Idle running can damage the mechanical seal and other parts.

The following issues are associate with idle running:

1. No liquid or little liquid in the water pump
2. Faults in the instrument used for testing the water flow in the pipes
3. Inadequate maintenance to the filter and the bottom valve
4. Damaged flanged gate valve in the water inlet pipe
5. Cavitation or vortex caused by inappropriate size and design of the piping system

7.8 IMPURITY OF THE LIQUID IN WATER PUMP

The liquid being pumped should be clear and clean. The pump is not designed for liquids that contain small solid particles. If the liquid contains solids, the manufacturer should be contacted for advice.

7.9 SUGGESTED SPARE PARTS

To avoid extended downtime, users should ensure that sufficient spare parts are available in order to carry out immediate repairs. Contact the manufacturer for advice on which parts should be held in stock.

When ordering spare parts, please provide:

1. Serial number and model of the water pump (indicated on nameplate) ;
2. Part number.

7.10 REPAIRS



WARNING:

1. Before returning the pump to the manufacturer for repair, the pump should be drained and the water or liquid washed out taking care to avoid any chemical reactions.
2. Used cleaning products should be correctly disposed of.
3. After washing the water pump, the liquid used for washing should be disposed properly.

7.11 DISMANTLING



WARNING:

Do not attempt to dismantle the pump by unqualified personnel.

To dismantle the pump:

1. Ensure that the pump is switched off
2. Disconnect the power supply
3. Close the inlet and discharge valves
4. Allow the pump to cool to room temperature
5. Wash all parts that have been in contact with the liquid; the liquid used for washing should be correctly disposed of;
6. Disconnect the pump from the system.

7.12 PRE-FILTER ROUTINE MAINTIANCE

The pre-filter basket should be inspected and cleaned weekly. If the O-ring is damaged it should be replaced.

1. Turn off the pump at the breaker.
2. Close the inlet and discharge valves.
3. Empty the water through drain on the pre-filter bottom.
4. Slowly release the 8 star screw fasteners on the lid to release the air pressure inside the filter
5. Remove the transparent lid and handle
6. Remove the O-ring and the cover.
7. Remove the PVC basket
8. Remove the debris and rinse out the basket.
9. Reinstall the cover, O-ring, transparent lid in reverse order and tighten the 8 star screw fasteners.
10. Ensure the O-ring is correctly seated.
11. Open the inlet and discharge valves.
12. Turn the power "ON" at the circuit breaker
13. Open the manual air relief valve on top of the filter.
14. Stand clear of the filter. Start the pump.
15. Bleed air from the filter until a steady stream of water comes out.
16. Close the manual air relief valve.

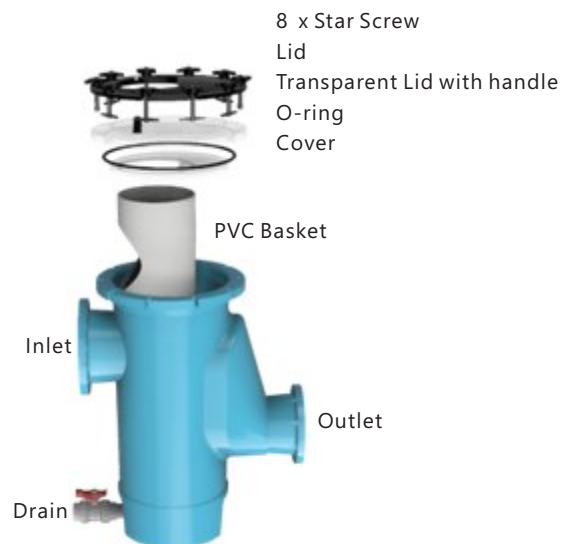

7.13 WINTERIZING

If the ambient temperature drops below 0°C (32°F), the water in the system can freeze and cause damage that is not covered by warranty.

To prevent freezing damage follow the procedures:

1. Switch off electrical power at the main circuit breaker.
2. Drain the water out of the pump case by removing the two drain plugs from the case.
3. Store the plugs in the pump basket.
4. Cover the motor to protect it from severe rain, snow and ice.
5. If it is possible, store the pump in a dry location during this time.
6. Do not wrap the motor in plastic. It will cause condensation and rust on the inside of the motor.
7. Where possible, have a qualified service technician or electrician disconnect the electrical wiring at the switch or junction box and store the pump indoors.
8. When the pump is reactivated, ensure all seals and O-rings are in operational condition. If they are not, re-greasing or replacing may be necessary.

8. DESCRIPTION OF SEA WATER PUMP PART

8.1 EXPLODED DIAGRAM OF THE WATER PUMP

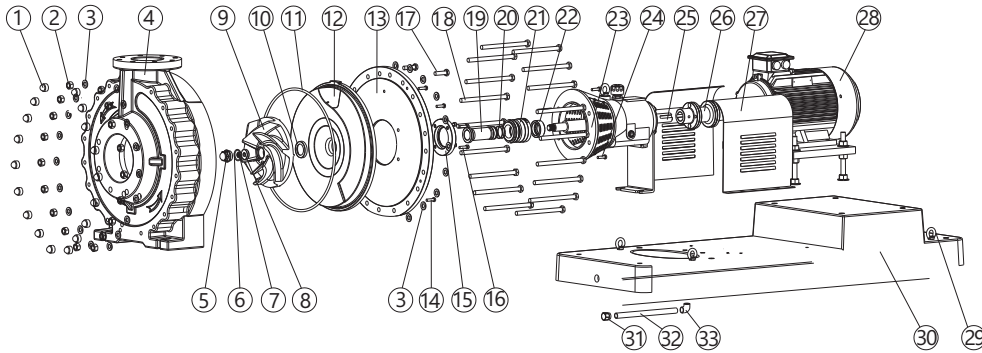

8.2 PARTS LIST

Key NO.	Part Name	Pump Model	QTY	Key NO.	Part Name	Pump Model	QTY	
1	M14 nut cap	4 x 3	12	12	Flange		1	
		6 x 4	14	13	Frame flange		1	
		8 x 6	18	14	M10 hexagonheadbolt	4 x 3, 6 x 4 only 4 bolts of 4x3 and 6x4	5	
2	M14 nut	4 x 3	12	14A	M8 hexagonheadbolt	No bolt of 8 x 6	1	
		6 x 4	14	15	Positioning flange		1	
		8 x 6	18	16	M8 hexagonhead bolt		4	
3	M14 gasket	4 x 3	24		M8 spring gasket		4	
		6 x 4	28	17	M14 bolts	4x3, 6x4 No bolts of 4x3 and 6x4	2	
		8 x 6	38			18	M14 threaded bolt	4 x 3
4	Pump body		1		6 x 4			14
5	Water leafnut		1					8 x 6
6	Leaf water ring nut		1	19	Shaft in stalling sleeve		1	
7	Water leafnut		1	20	The sleevering		2	
8	Water leaf gasket		1	21	Mechanical seal kits		1	
9	Waterleaf		1	22	Locating ring		1	
10	Water leaf rubberpad		1	23	Supporting rack		1	
11	Flange drubberring		1					

8.3 DESCRIPTIONS OF MAIN PARTS

8.3.1 PUMP BODY

The pump body contains water suction entrance, water inlet and water outlet, they are all on the direction of the shaft; it complies with the requirements of equipment.

8.3.2 IMPELLER

The impeller is of the half-open type; the vane on the back of the impeller reduce the cavitation caused by the flow the water. The impeller size varies according to the design flow of the pump.

8.3.3 SHAFT

The shaft conveys the rotational movements produced by drive unit to the vane. The shaft connects with the drive unit through a flexible connector and gasket. The frame and two bearings bear the shaft at the same time.

8.3.4 SEALS

Sealing parts include mechanical sealing and various rubber rings and rubber gasket.

8.3.5 BEARINGS

Roller bearings are used in water pump. These bearings are lubricated with oil. Their temperature should be tested frequently when the water pump is running.

8.3.6 MECHANICAL SEALING

Mechanical seals prevent leakage from the pump. Different models and brands of seals can be used. At the time of ordering, the type of the mechanical seal should be determined by the running environment of the pump and the type of the liquid to be pumped.

8.3.7 FRAME

The frame is an integrated structure, with a shaft supported by two bearings. The structure of the frame is determined by the model of the water pump.

8.3.8 BASE, COUPLING, COUPLING PROTECTIVE COVER

The base is made of fiberglass and is equipped with a protective cover made by stainless steel for the coupling. The coupling uses an elastic connection equipped with a gasket.

8.4 BREAK-OUT SECTIONS OF MAIN PARTS

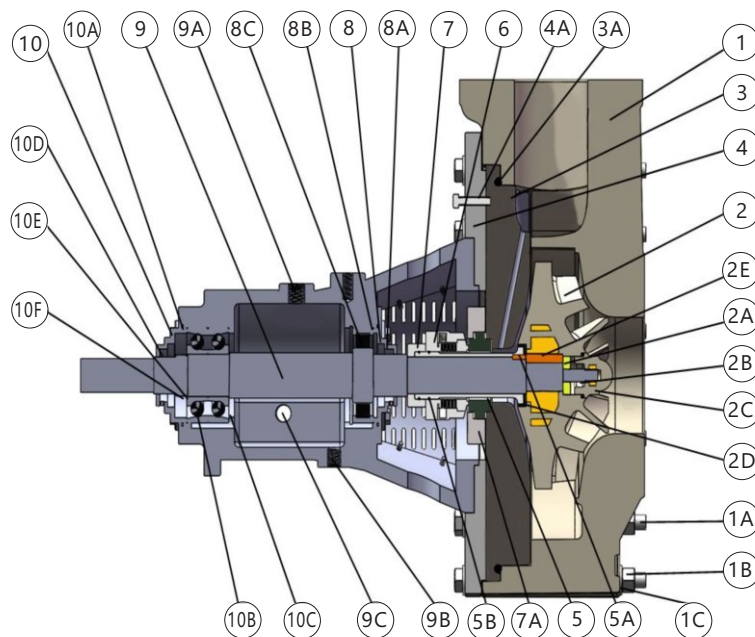

Parts No.	Name	Parts No.	Name	Parts No.	Name	Parts No.	Name
1	Pump body	3	Flange	7A	Retaining flange	10	The rear cover of the supporting rack
1A	M14 bolt	3A	Flanged rubber ring	8	The front cover of the supporting rack	10A	The rubber ring of the rear cover
1B	M14 nut	4	Frame flange	8A	Front oil seal	10B	Rear bearings
1C	M14 gasket	4A	Set screw	8B	The rubber ring of the front cover	10C	Snap ring
2	Water leaf	5	Shaft installing sleeve	8C	Front bearing	10D	Rear oil seal
2A	Water leaf gasket	5A	Key sleeve	9	Crankshaft	10E	Gasket
2B	Water leaf nut	5B	The sleeve ring	9A	Oil inlet	10F	Lock nut
2C	Water leaf screw cap	6	Mechanical sealing	9B	Oil outlet		
2D	Water leaf rubber shim	7	Locating ring	9C	Inspection glass for oil level		

9. TROUBLE SHOOTING

Problem	Cause	Trouble shooting method
The pump does not work function or the suction speed is low during self- priming	The end of the water inlet pipe or the bottom valve is not completely immersed in liquid	Immersing the end of the water inlet pipe or the bottom valve in water according to suggested distance
	The bottom valve is too small or has not been correctly installed.	Check or change the bottom valve
	The suction height exceeds the value indicated	Check the suction height to ensure that it doesn't exceed the limit of the water pump or the height of liquid in suction tank isn't too low
	The suction tube is too long or the diameter is too small	Check the suction height to ensure that it does not exceed the limit of the pump, or that the depth of liquid in suction tank is no too low.
	There's air leakage in the suction tube	Check the seal ring and re-screwing the connections between pipes
	The valve in the suction tube is closed or half closed	Fully open the valve of the suction tube
	The proportion, temperature and viscosity of the liquid exceeds the maximum designed value	Check the proportion, temperature and viscosity of the liquid
	Exterior solids are blocking the impeller or water outlet.	Clearing the blockage
	The impeller is damaged or the distance between the impeller and the body exceeds the maximum suggested value	Reduce the distance between the impeller and the body, or change the impeller
	The valve of the water outlet closes	Open the valve of the water outlet
	Motor phase missing	Check the supply power of the motor
	The rotation speed is too low	Check connection lines
Speed induction failure	Check connection lines	
The frequency of the current source isn't suitable to the water pump	Check the frequency of the current source	

Problem	Cause	Trouble shooting method
Inadequate rate of flow or pressure	Air in pipes	Check the condition of pipes
	Air in the pipes or gas in the liquid	Check the condition of liquid
	The exterior solids block the water leaf or water outlet	Clearing the blockage
	The impeller is damaged or the distance between the impeller and the body exceeds the maximum suggested value	Reduce the distance between the impeller and the body, or change the impeller
	The total pumping head of the whole system is larger than the total pumping head of the water pump	Check the loss and the condition of the whole system
	The viscosity of liquid exceeds the designing value	Check the proportion, temperature and viscosity of the liquid
	The rotating speed is too low	Check connection lines
	Speed induction failure	Check the connection line
	The current frequency is not correct for the electric motor	Check the frequency of the electricity supply
The water pump vibrates severely	Cavitation	Check the whole system to find the cause of cavitation
	The working point is not within suggested flow range	Adjust working point according to suggested flow range
	Solids are blocking the impeller or the discharge port	Clearing the blockage
	One or more parts of the water pump are damaged	Dismantle the water pump and change the damaged parts
	The pump or motor bearings are worn	Change the worn-out bearings
	The base has not been firmly fixed properly	Bolt the base firmly to the concrete floor or plinth
	The mounting screws are loose	Screw bolts
	The elastic parts in the coupling wear	Change elastic parts in the coupling
	The water pump doesn't align correctly	Check the alignment of the water pump
Over heating of the motor	The proportion or viscosity of the liquid pumped exceeds the designing value	Check the value of proportion and viscosity
	The temperature of the working environment is too high	Ensure the pump has been correctly installed away from sources of heat
	The rotating speed is too high	Check connection lines
Over heating of the motor	The pressure on the mechanical sealing is too high	Contact with the manufacturer
	There are flaws on the hull or on the motor bearings	Change the water pump or the bearings of the motor
	The pump body and the motor are misaligned	Realign the pump body and the motor
	The liquid in the water pump contains solid particles or abrasive material	Check the content of solid particles contained in liquid to ensure that it doesn't exceed the specified maximum value
	The material used for mechanical sealing is incompatible with the liquid of the water pump	Contact with the manufacturer
	The liquid of the water pump formsgas	Contact with the manufacturer
The loss of mechanical sealing is too fast	The working point is not within suggested flow range	Adjust working point according to suggested flow range
	Idling running	Check the installation and running of the water pump
	The pump body and the motor are misaligned	Realign the pump body and the motor

Problem	Cause	Trouble shooting method
The loss of bearings is too fast	The working point is not within suggested flow range	Adjust working point according to suggested flow range
	There is no oil in the bearing bracket	Add oil
	The oil contains solid particles	Ensure the oil is clean or replace the oil
	Water or condensate appears on the bearings or on motor	Contact the manufacturer
	Bearing overloading caused by mechanical defects	Contact the manufacturer
	Mechanical breakdown or damages of the water pump	Contact the manufacturer
	The pump body and the motor are misaligned	Realign the pump body and the motor

10. TERMS OF THE WARRANTY

As original purchaser of this equipment have purchased from Emaux Water Technology Co Ltd, through Authorized International Distributor or Dealer, warrants its products free from defects in materials and workmanship under normal use during warranty period. The warranty period begins on the day of purchase and extends only to the original purchaser. It is not transferable to anyone who subsequently purchases the product from you. It excludes all expendable parts.

During the warranty period, Emaux authorized reseller will repair or replace defective parts with new parts or, at the option of Emaux, serviceable used parts that are equivalent or superior to new parts in performance.

This Limited Warranty extends only to products purchased from Emaux authorized reseller. This Limited Warranty does not extend to any product that has been damaged or rendered defective

1. as a result of accident, misuse or abuse;
2. as a result of an act of God;
3. by operation outside the usage parameters stated herein;
4. by the use of parts not manufactured or sold by Emaux;
5. by modification of the product;
6. as a result of war or terrorist attack; or
7. as a result of service by anyone other than Emaux authorized reseller or authorized agent.

EXCEPT AS EXPRESSLY SET FORTH IN THIS WARRANTY, EMAUX MAKES NO OTHER WARRANTIES EXPRESSED OR IMPLIED, INCLUDING ANY IMPLIED WARRANTIES OR MERCHANTABILITY AND FITNESS FOR A PARTICULAR PURPOSE. EMAUX EXPRESSLY DISCLAIMS ALL WARRANTIES NOT STATED IN THIS LIMITED WARRANTY. ANY IMPLIED WARRANTIES THAT MAY BE IMPOSED BY LAW ARE LIMITED TO THE TERMS OF THIS EXPRESS LIMITED WARRANTY.

EMAUX WATER TECHNOLOGY CO., LTD

ADDRESS FLAT A-D, 20/F., KAI BO 22, 22 WING KIN ROAD,
KWAI CHUNG, HONG KONG

PHONE +852 2832 9880

 **STRIVE FOR CLEAR WATER**

www.emauxgroup.com